



airc-pirates.com

AP Super Tucano

Version 0.4 (2018-11-23)

Design & Drawing by: Tony Roehling



BETA

GENERAL SPECIFICATIONS

WINGSPAN:	800 mm		31.50 in
CG:	45 mm		1.77 in
LENGTH:	680 mm		26.77 in
DRY WEIGHT:	304 g		10.72 oz (TYPE S)
ALL UP WEIGHT:	390 g		13.76 oz (TYPE S)
EXPO:	30 %		
CHANNELS:	4 (THR AIL ELV RUD)		

RECOMMENDED SETUPS

	<u>TYPE S</u>	<u>TYPE R</u>
MOTOR:	2300 kv (2205)	2300 kv (2205)
PROPELLER:	6x4	6x4
ESC:	20A	30 A
SERVOS:	4 x 5 g	4 x 9 g
BATTERY:	1000 mAh 3s	1300 mAh 4s



DRAWING KEY

... based on the Flite Test Drawing Key created by Dan Sponholz

FOLD TYPES

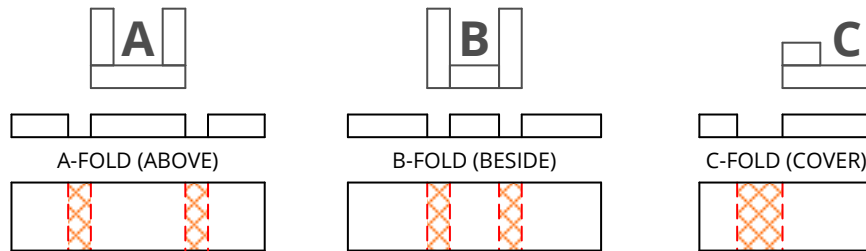

LINE TYPE/COLOR

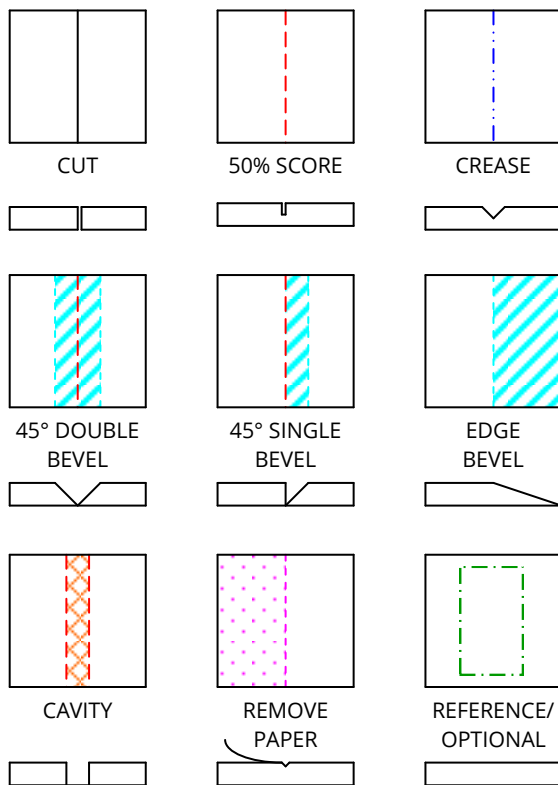

SYMBOLS

PART NUMBER

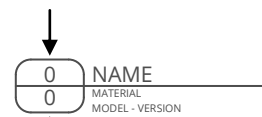

QUANTITY



DOWEL HOLE



CENTER OF GRAVITY (CG)

BETA

AP Super Tucano

PARTS LIST

Version 0.4 (2018-11-23)

PART NR.	DESCRIPTION	QUANTITY	MATERIAL	SHEET
G1	90° TRIANGLE	1	FOAM BOARD	2
G2	DIHEDRAL GAUGE	1	FOAM BOARD	2
G3	THROW GAUGE	1	FOAM BOARD	1
1	FUSELAGE	1	FOAM BOARD	1
2	INNER SUPPORT	1	FOAM BOARD	1
3	NOSE AIR INTAKE	1	FOAM BOARD	1
4	POWER POD PLATE	1	FOAM BOARD	1
5	POWER POD SPACER	2	FOAM BOARD	1
6	EXHAUST	2	FOAM BOARD	1
7	LEFT DOUBLER	1	FOAM BOARD	1
8	RIGHT DOUBLER	1	FOAM BOARD	1
9	LEFT WING	1	FOAM BOARD	2
10	RIGHT WING	1	FOAM BOARD	2
11	FRONT SPAR	2	FOAM BOARD	2
12	REAR SPAR	2	FOAM BOARD	2
13	WING SHEETING	1	FOAM BOARD	2
14	ELEVATOR COMBINER	1	STEEL WIRE (Ø 1mm)	2
15	HORIZONTAL STABILIZER	1	FOAM BOARD	2
16	VERTICAL STABILIZER	1	FOAM BOARD	2
17	UPPER WINDOW	1	FOAM BOARD	1
18	CANOPY MOUNT SUPPORT	1	FOAM BOARD	1
19	LEFT WINDOW	1	FOAM BOARD	1
20	RIGHT WINDOW	1	FOAM BOARD	1
21	UPPER REAR SHEETING	1	FOAM BOARD	1
22	DETAILED PART A	1	FOAM BOARD	1
23	DETAILED PART B	1	FOAM BOARD	1
24	DETAILED PART C	1	FOAM BOARD	1
25	NOSE SHEETING	1	FOAM BOARD	1
26	CONTROL HORN	4	PLASTIC CARD	2
27	CANOPY MOUNT PIN	1	BBQ SKEWER	1
28	POWER POD MOUNT PIN	2	BBQ SKEWER	1
FT1	FT MINI POWER POD	1	FOAM BOARD	2
FT2	FT MINI FIREWALL	1	PLYWOOD	2
	OTHER MATERIALS			
	STEEL WIRE (Ø 1mm) FOR THE LINKAGE RODS			
	SERVO EXTENSIONS: 2 x 150mm, 2 x 300mm			
	VELCRO TO MOUNT THE BATTERY, ESC, 3 x COFFEE STIRRER, ...			

Please build the Super Tucano in the order of the part numbers!

AP Super Tucano

Design & Drawing by: Tony Roehling

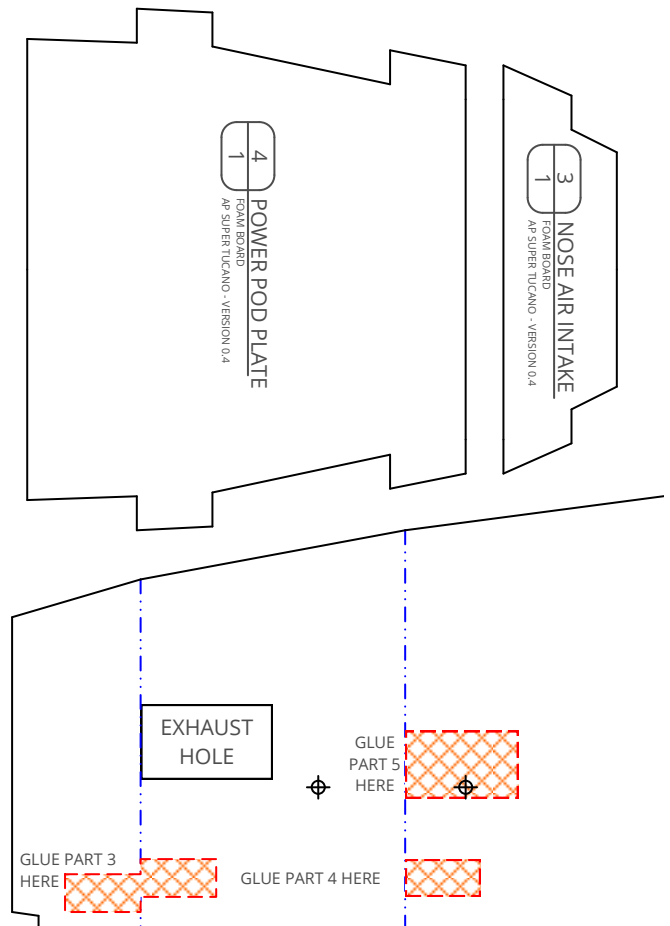

10 - VERSION 0.4 (2018-11-23)

BETA

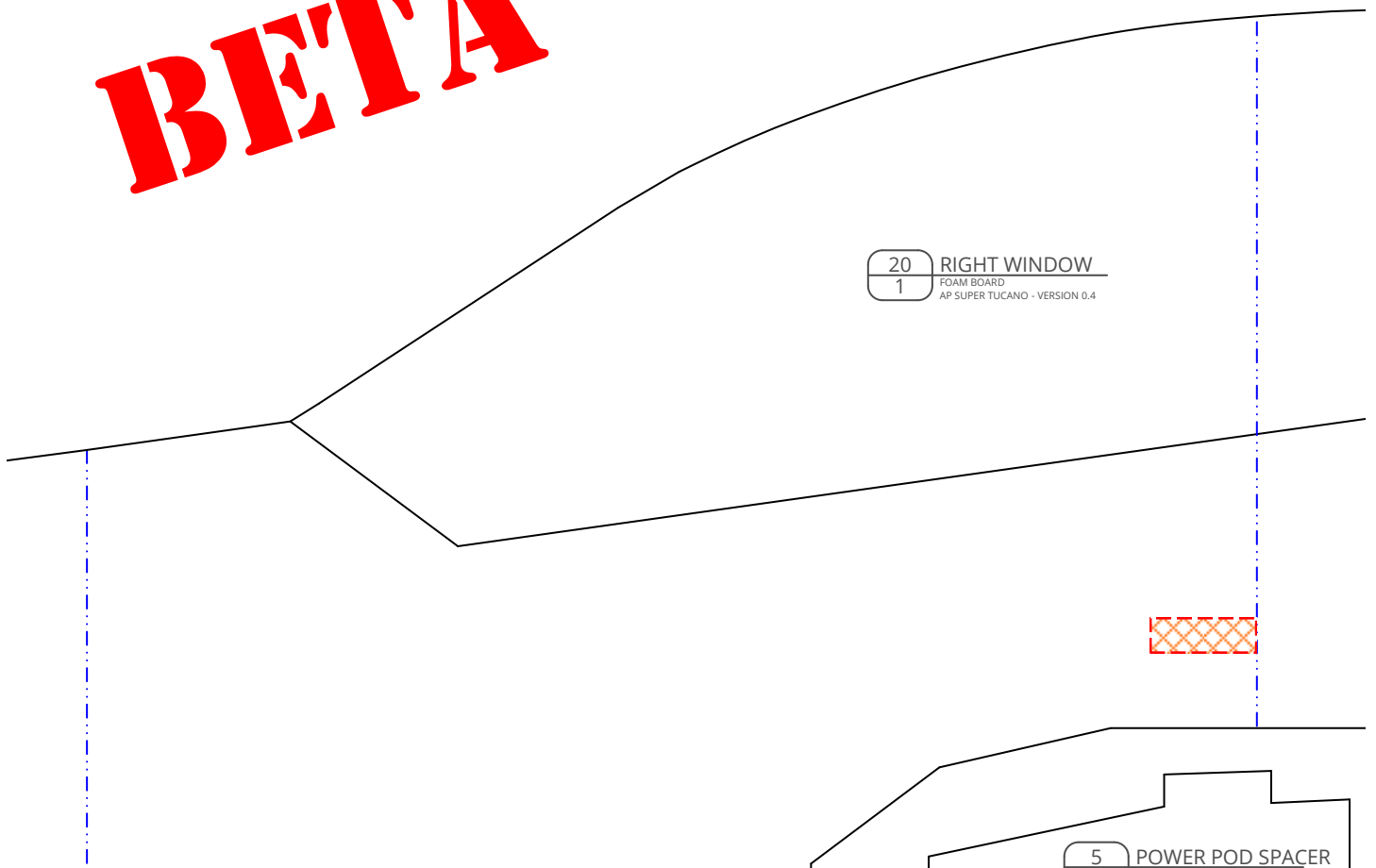

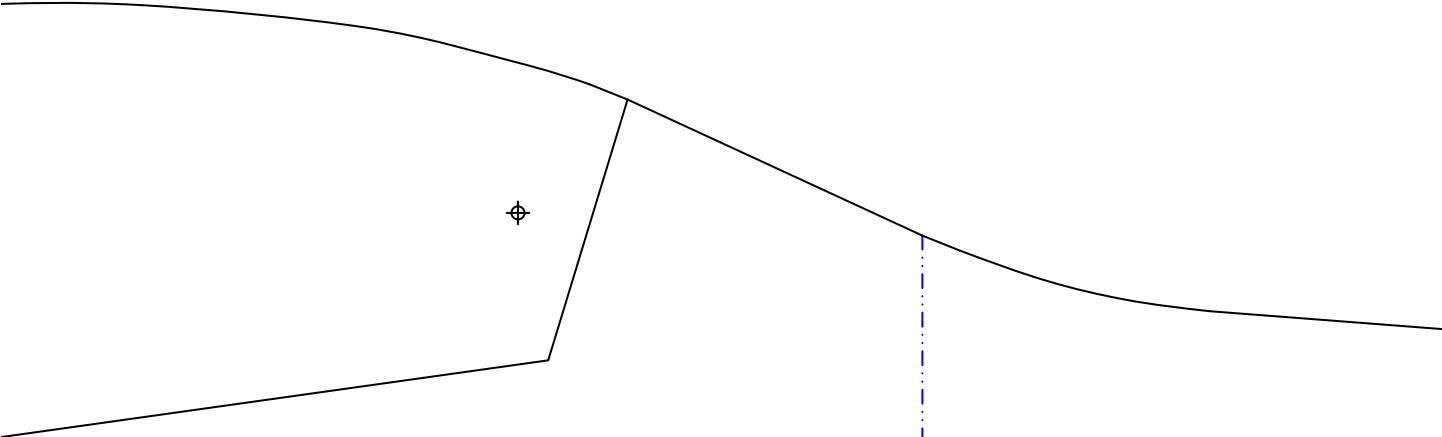

GLUE PART 2 HERE

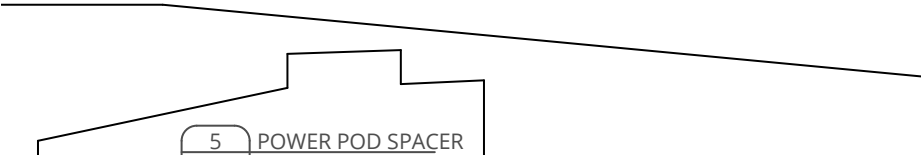

in 
cm 

27 CANOPY MOUNT PIN
BBQ SKEWER
1 AP SUPER TUCANO - VERSION 0.4

9g SERVO HOLE
5g SERVO HOLE



28 POWER POD MOUNT PIN
2 BBQ SKEWER
AP SUPER TUCANO - VERSION 0.4

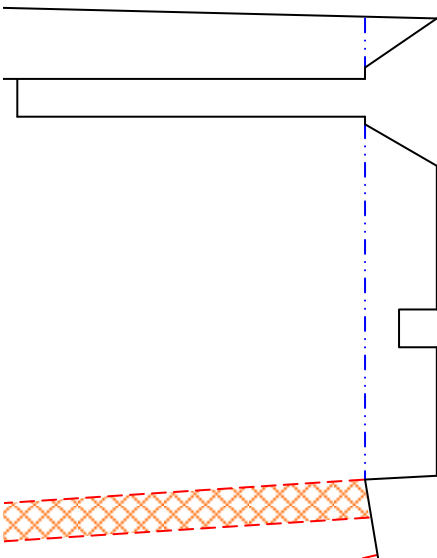

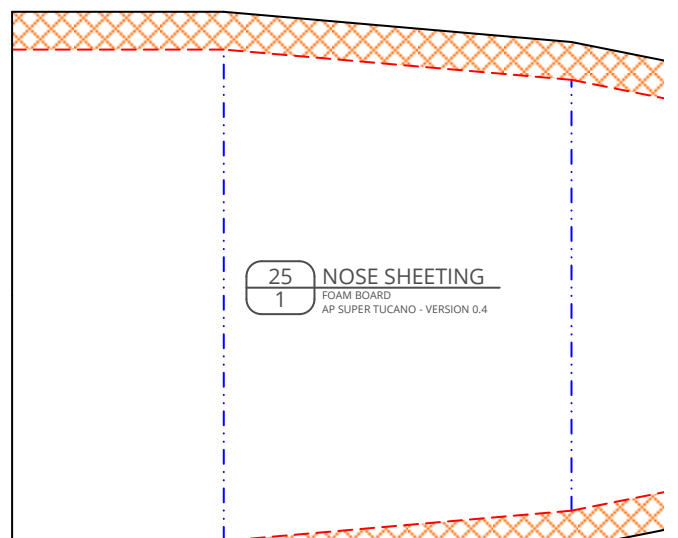
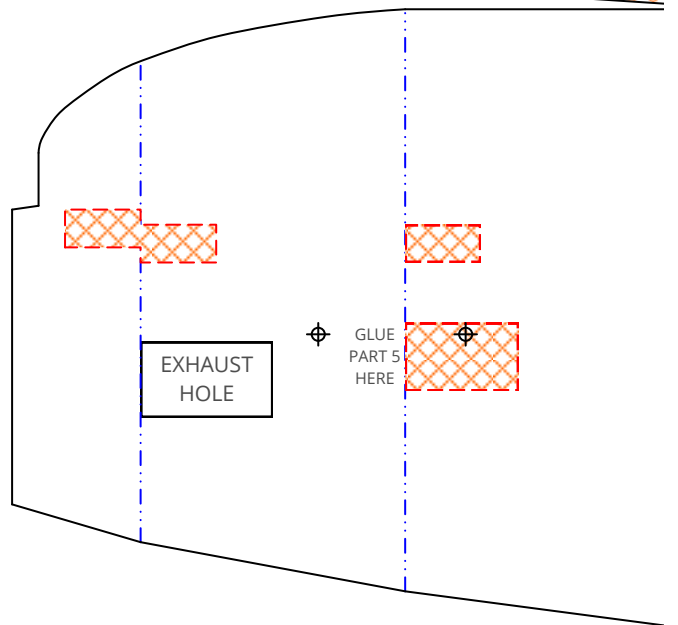
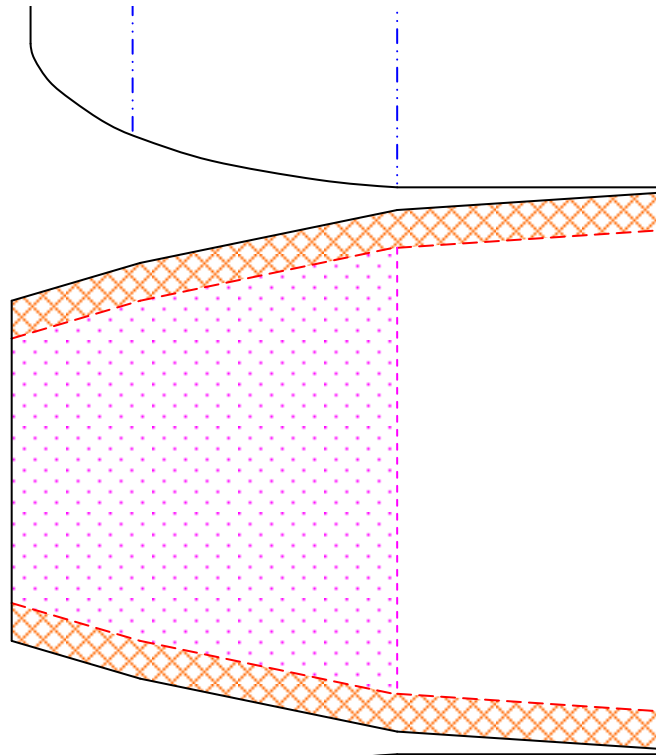



1 FUSELAGE
FOAM BOARD
AP SUPER TUCANO - VERSION 0.4

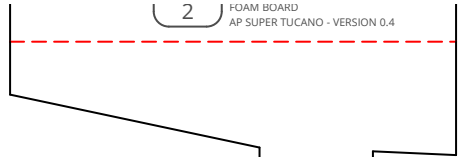

2 FOAM BOARD
AP SUPER TUCANO - VERSION 0.4

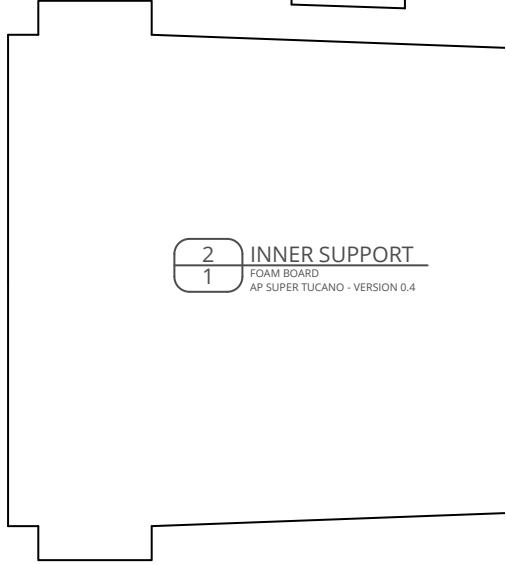

2 INNER SUPPORT
FOAM BOARD
AP SUPER TUCANO - VERSION 0.4

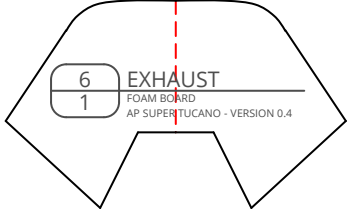

6 EXHAUST
FOAM BOARD
AP SUPER TUCANO - VERSION 0.4

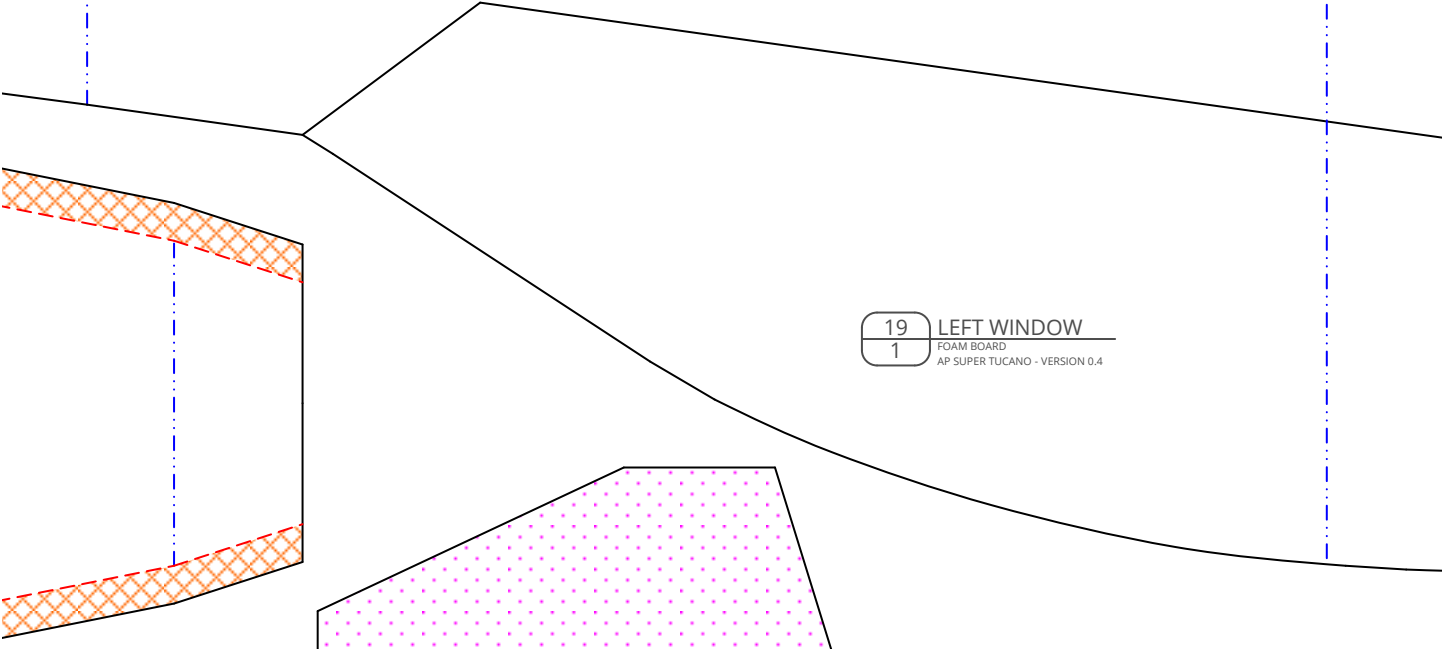

19 LEFT WINDOW
FOAM BOARD
AP SUPER TUCANO - VERSION 0.4

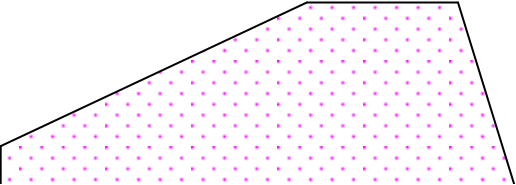

2

FOAM BOARD
AP SUPER TUCANO - VERSION 0.4

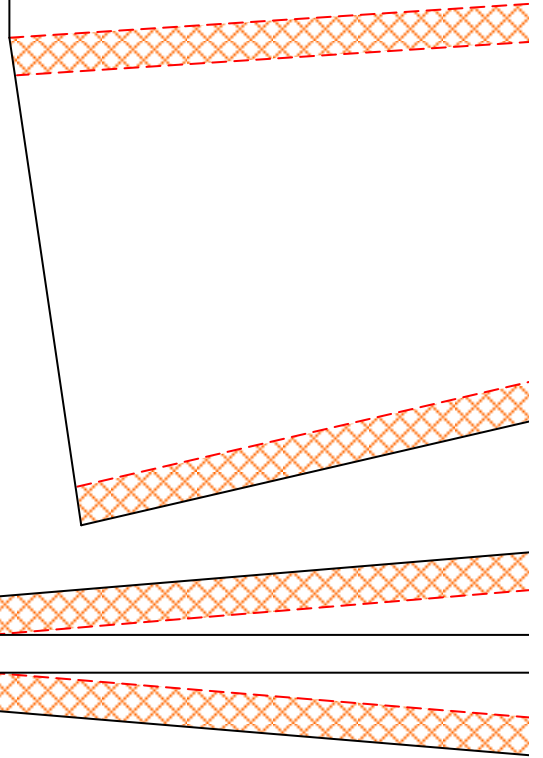
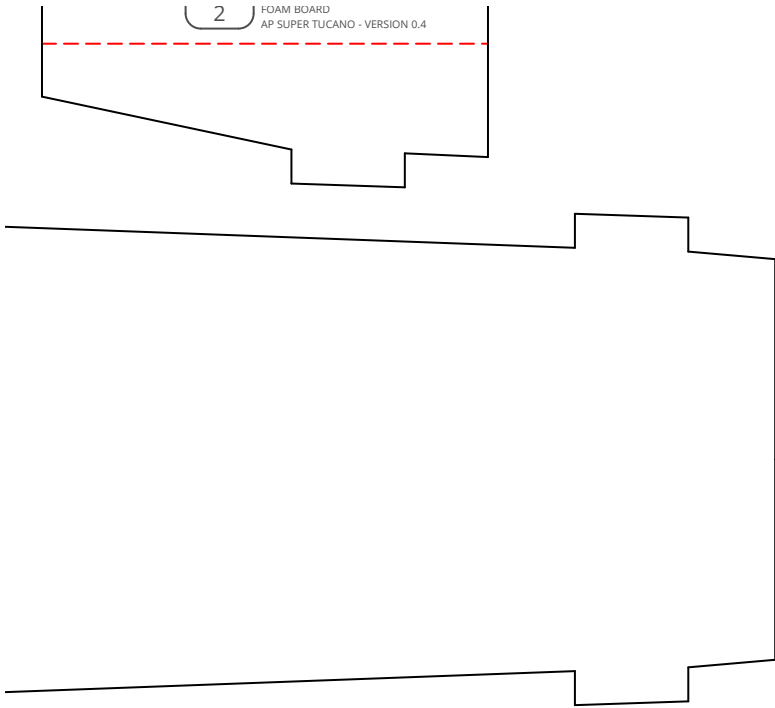

6

EXHAUST

1

FOAM BOARD
AP SUPER TUCANO - VERSION 0.4

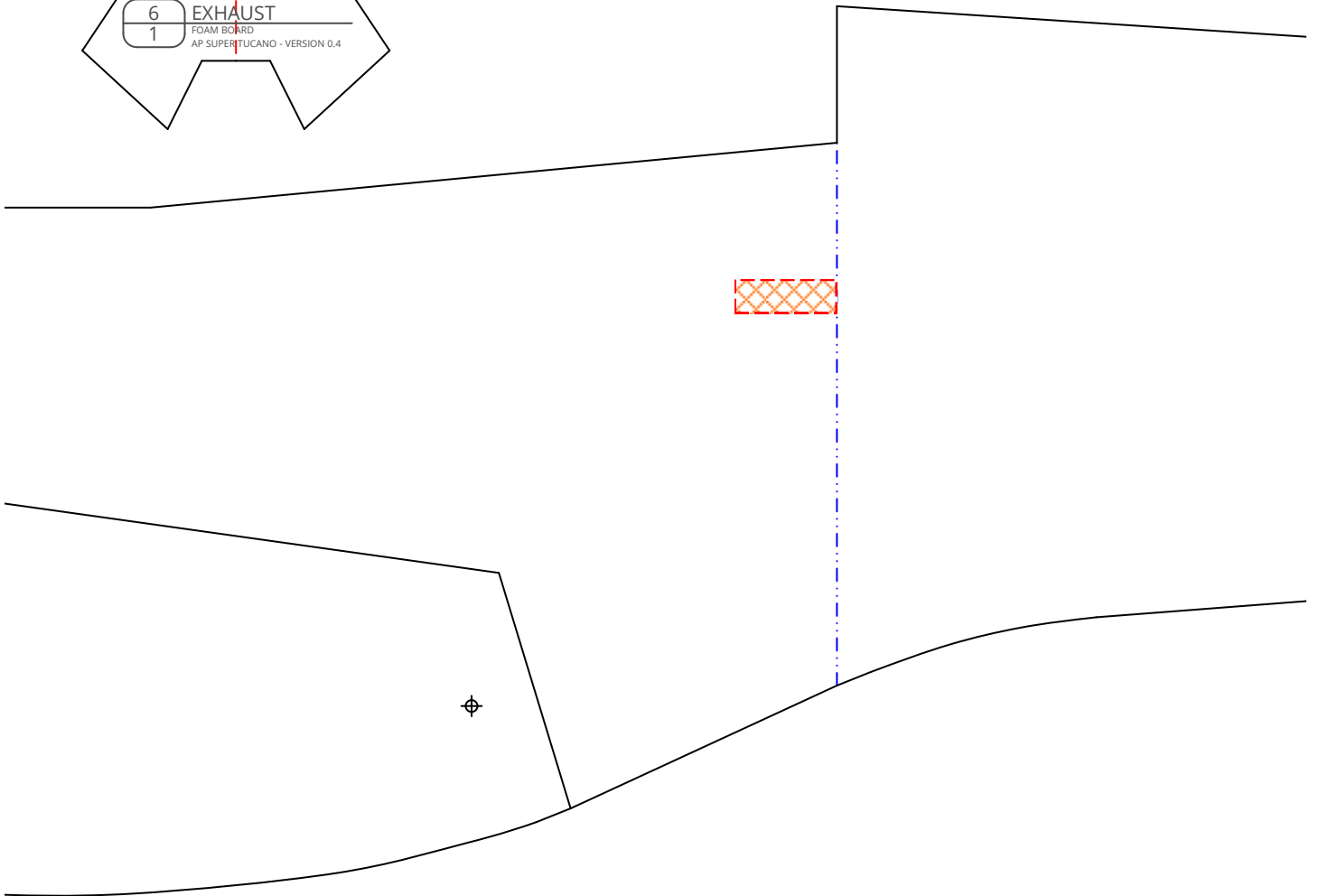
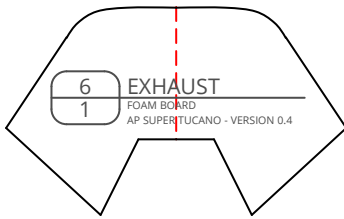

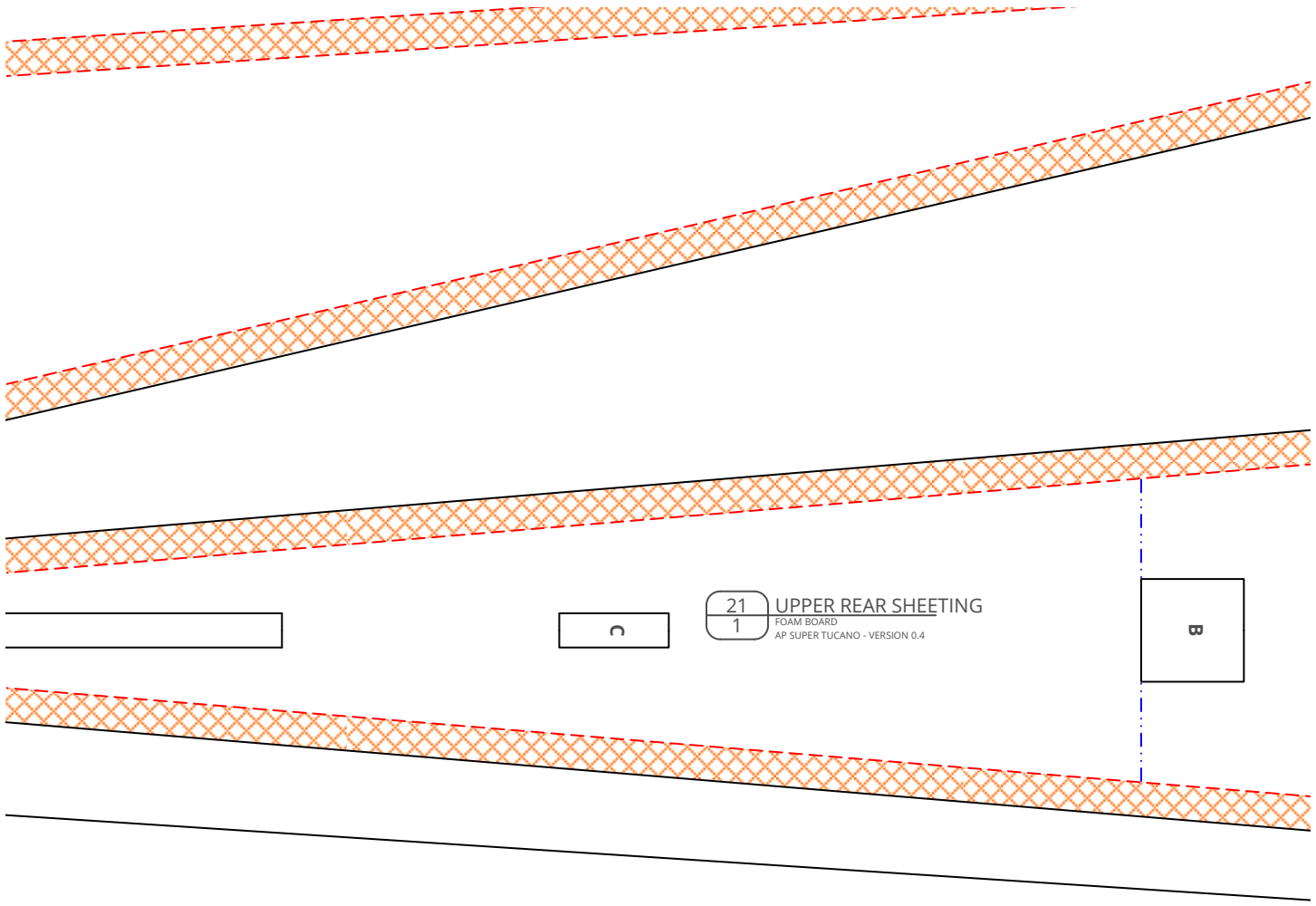

21 UPPER REAR SHEETING
FOAM BOARD
AP SUPER TUCANO - VERSION 0.4

C

B

9g SERVO HOLE

5g SERVO HOLE

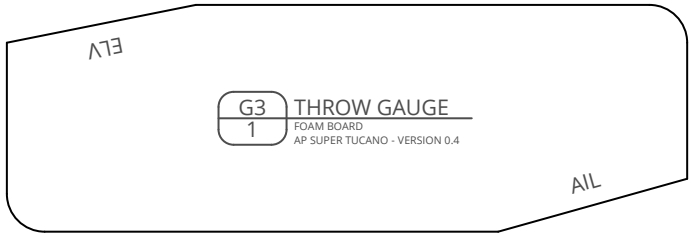

G3 THROW GAUGE
FOAM BOARD
AP SUPER TUCANO - VERSION 0.4

ELV

AIL

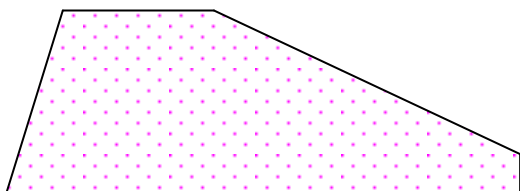
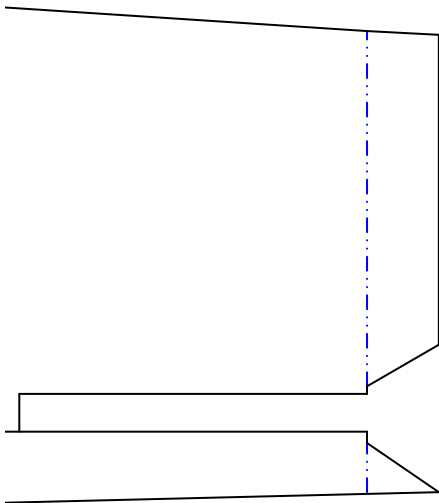
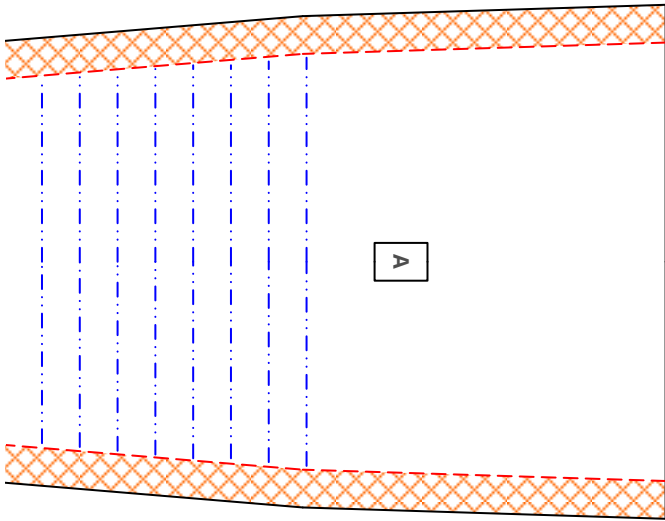
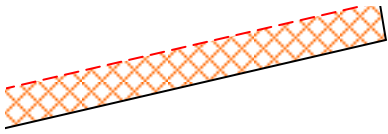

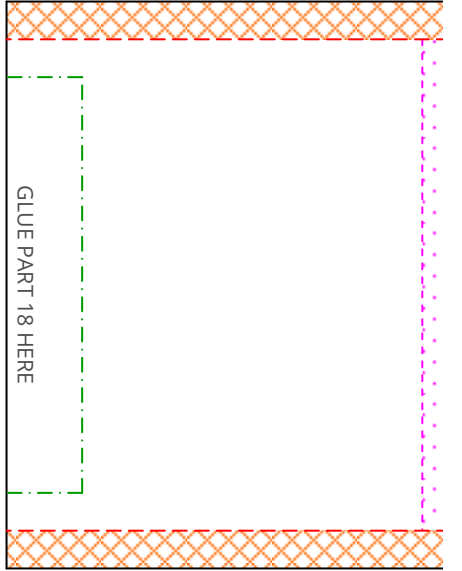

18	CANOPY MOUNT SUPPORT
1	FOAM BOARD
AP SUPER TUCANO - VERSION 0.4	



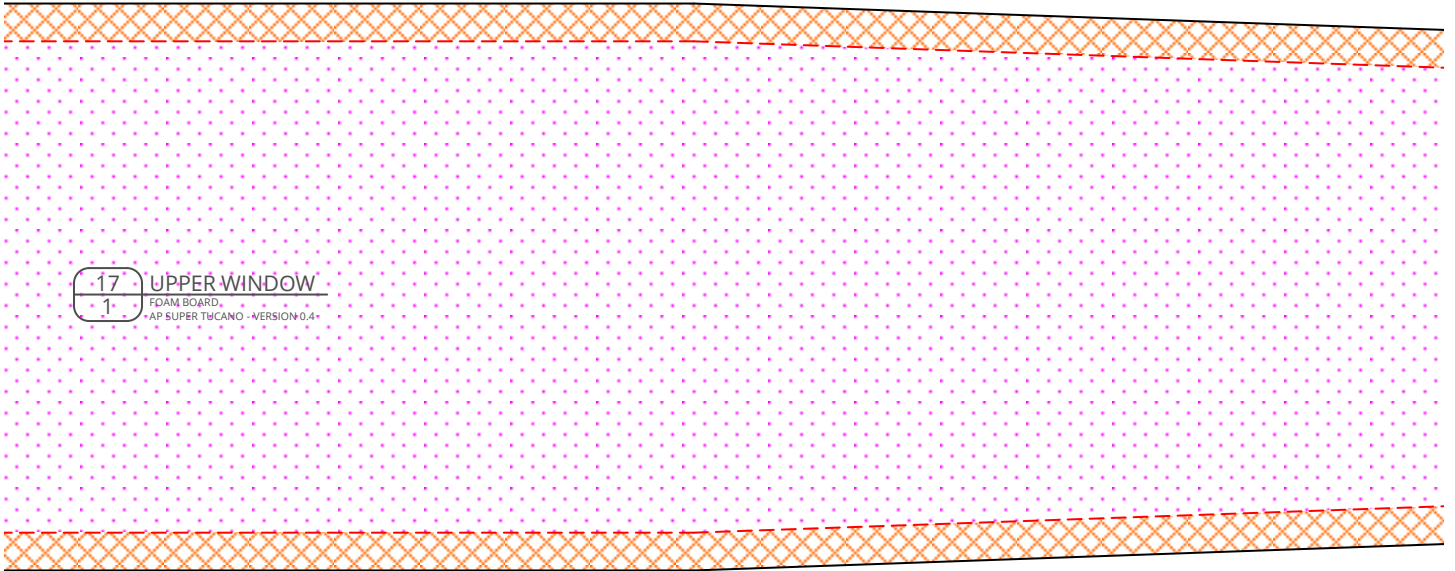
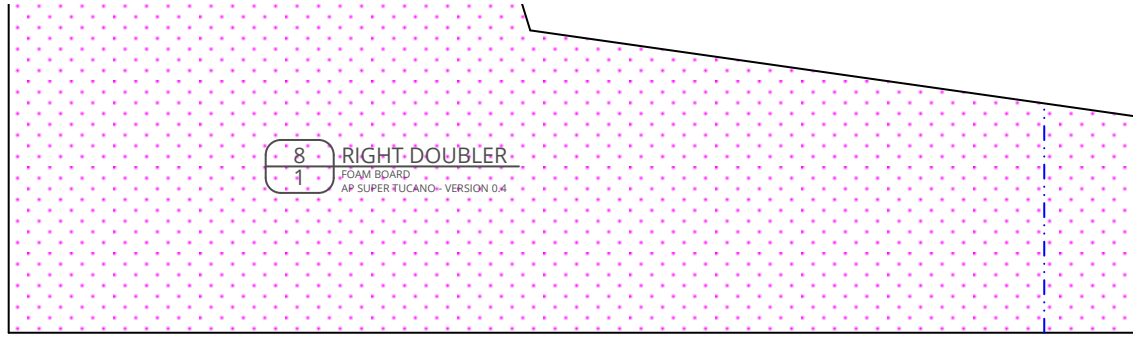

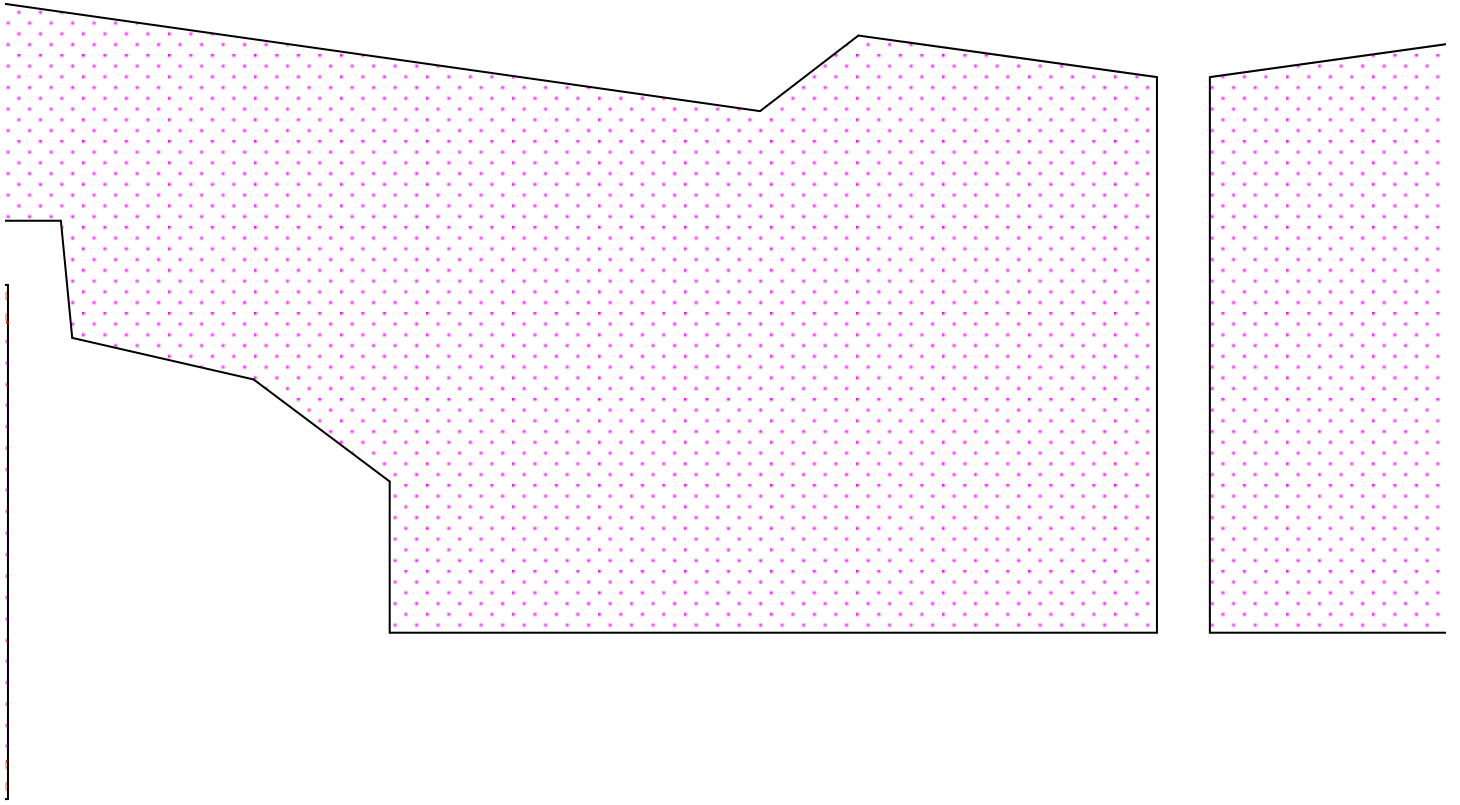

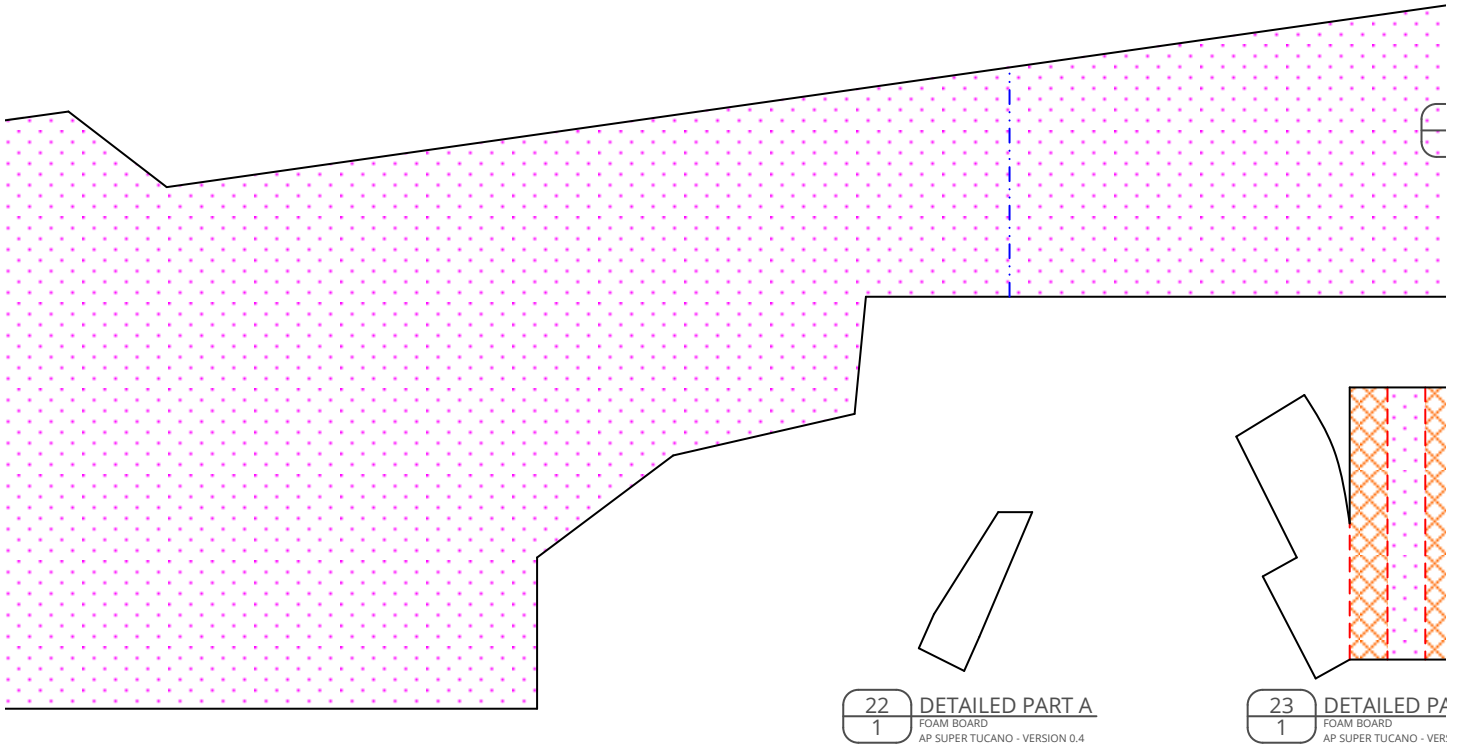

22 DETAILED PART A
1 FOAM BOARD
AP SUPER TUCANO - VERSION 0.4

23 DETAILED PART B
1 FOAM BOARD
AP SUPER TUCANO - VERSION 0.4

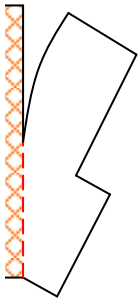

ART B
SION 0.4

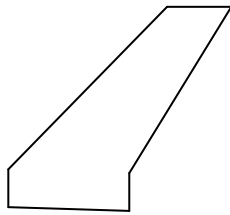

24 DETAILED PART C
FOAM BOARD
1 AP SUPER TUCANO - VERSION 0.4

free of charge. Copies allowed for personal use only. Not for commercial use.

AP Super Tucan

Design & Drawing by: Tony Roehling

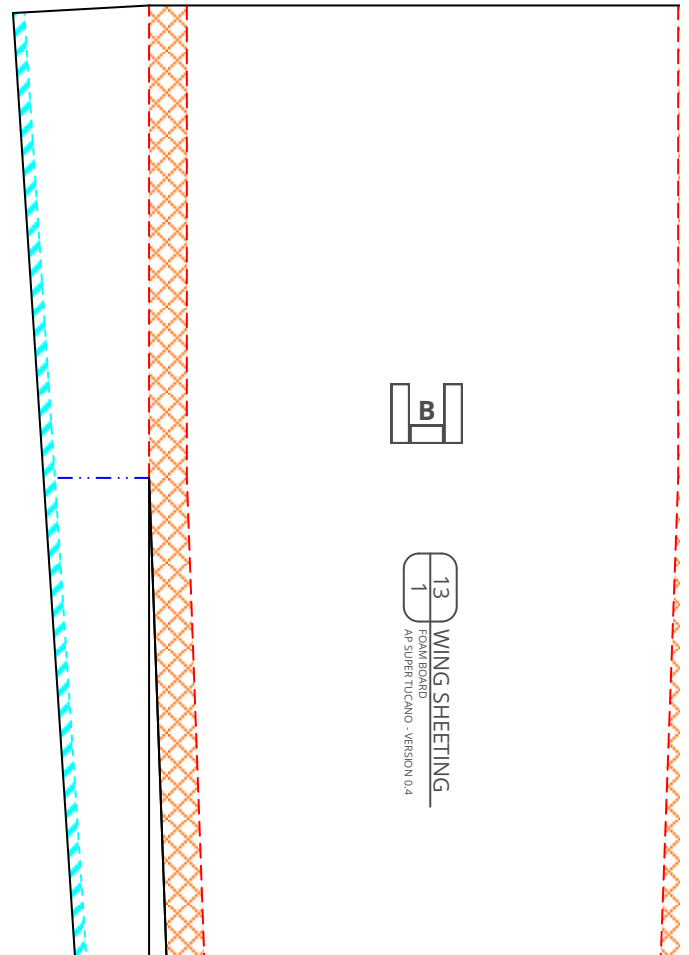

10 - VERSION 0.4 (2018-11-23)

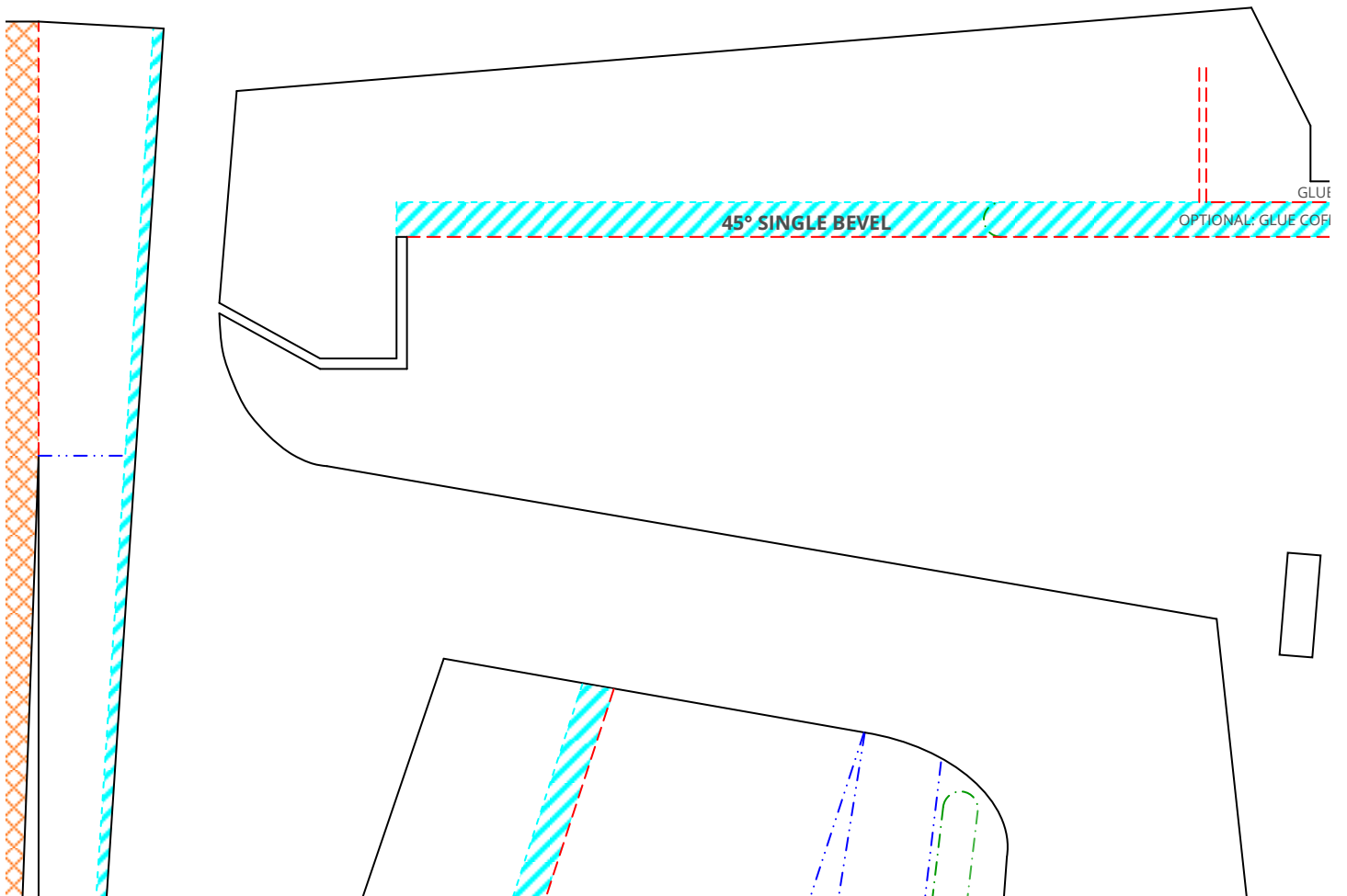

PART 14 HERE

SEE STIRRER ON THE UPPER SIDE

15 HORIZONTAL STABILIZER
1 FOAM BOARD
AP SUPER TUCANO - VERSION 0.4

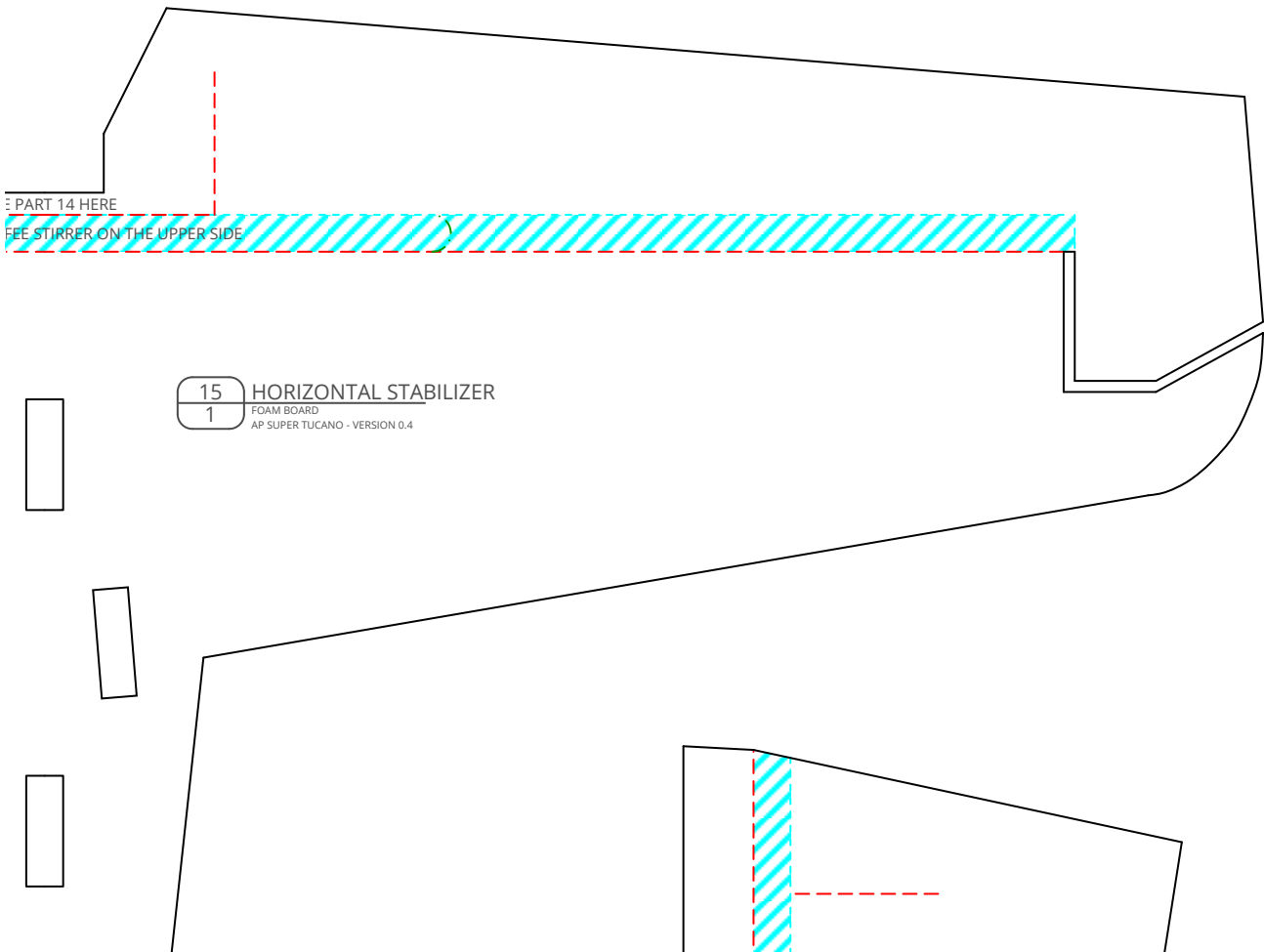

in 
cm 

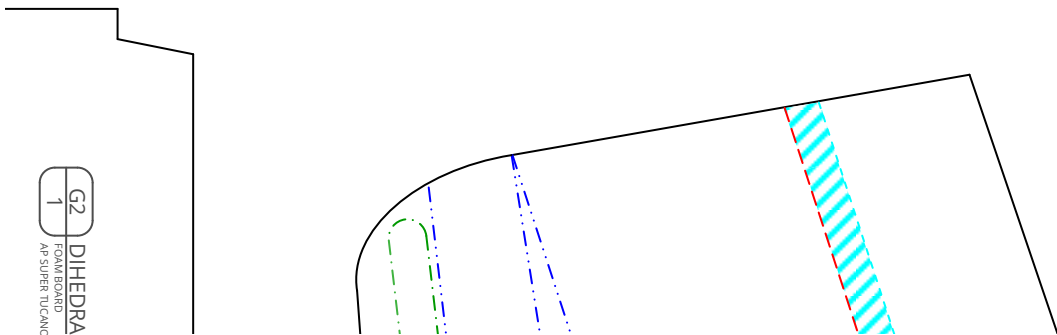
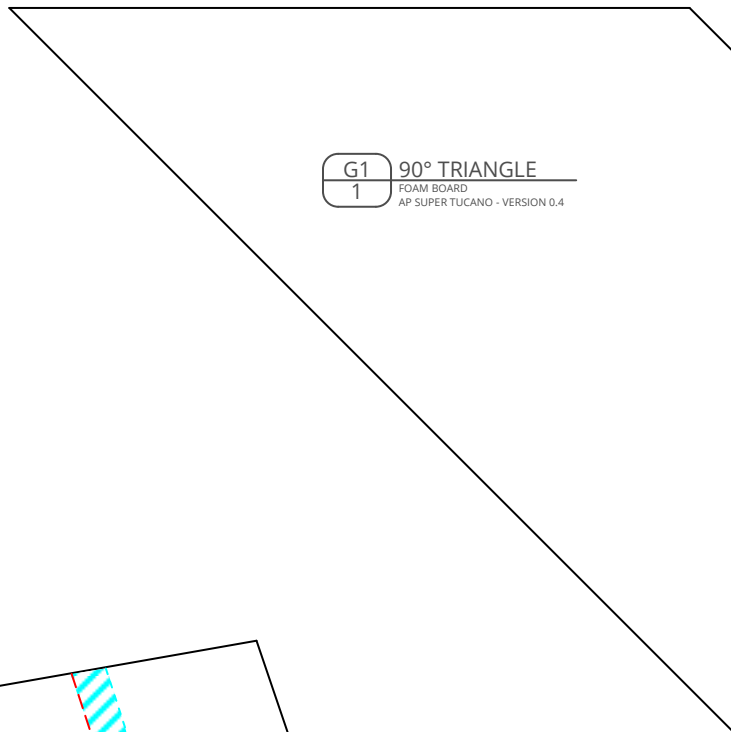
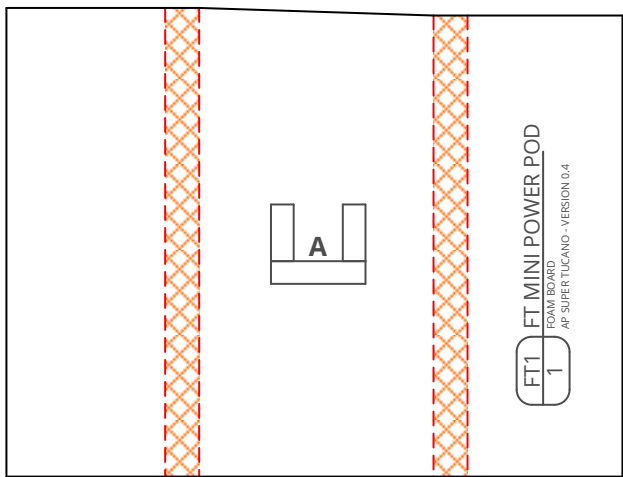



12 REAR SPAR
FOAM BOARD
2 AP SUPER TULCANO - VERSION 0.4

12 REAR SPAR
FOAM BOARD
2 AP SUPER TULCANO - VERSION 0.4

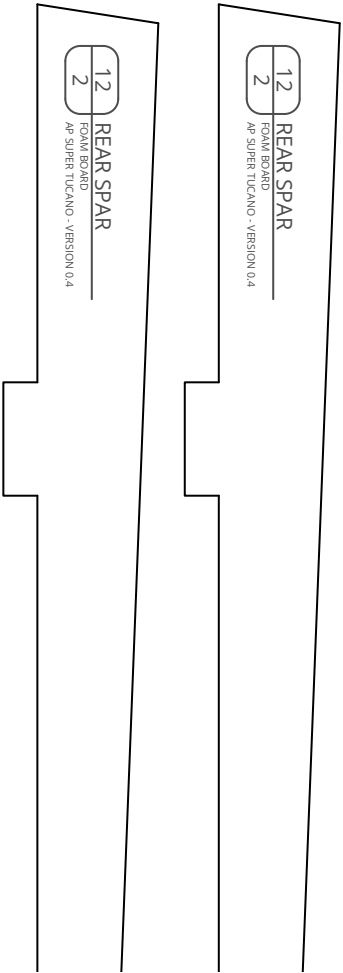
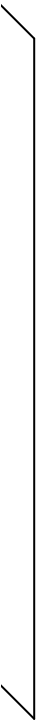

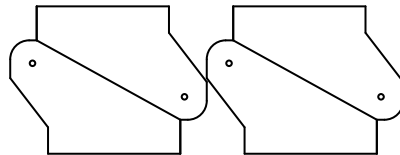
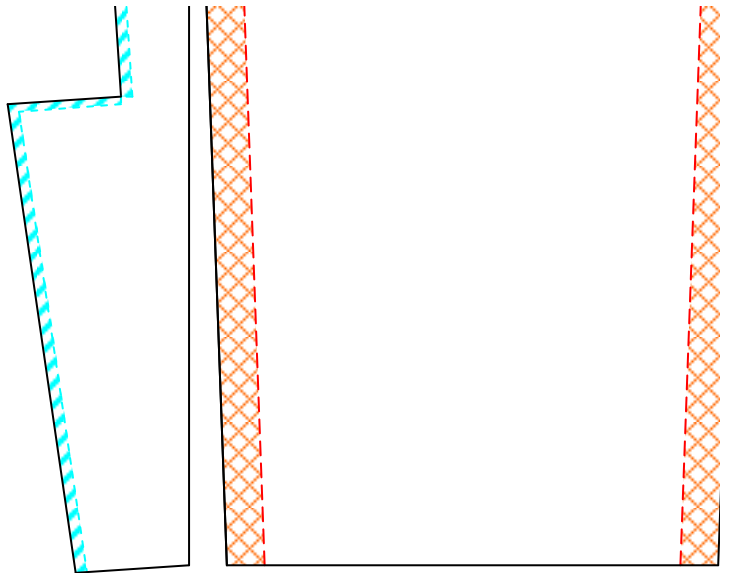

26 CONTROL HORN
4 PLASTIC CARD
AP SUPER TUCANO - VERSION 0.4

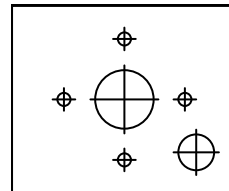

FT2 FT MINI FIREWALL
1 PLYWOOD
AP SUPER TUCANO - VERSION 0.4

BETA

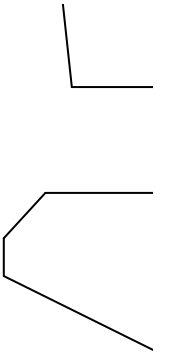

5g SERVO HOLE

9g SERVO HOLE



GLUE PART 11 HERE

OPTIONAL: GLUE COFFEE STIRRER HERE

DOUBLE BEVEL

45° SINGLE BEVEL

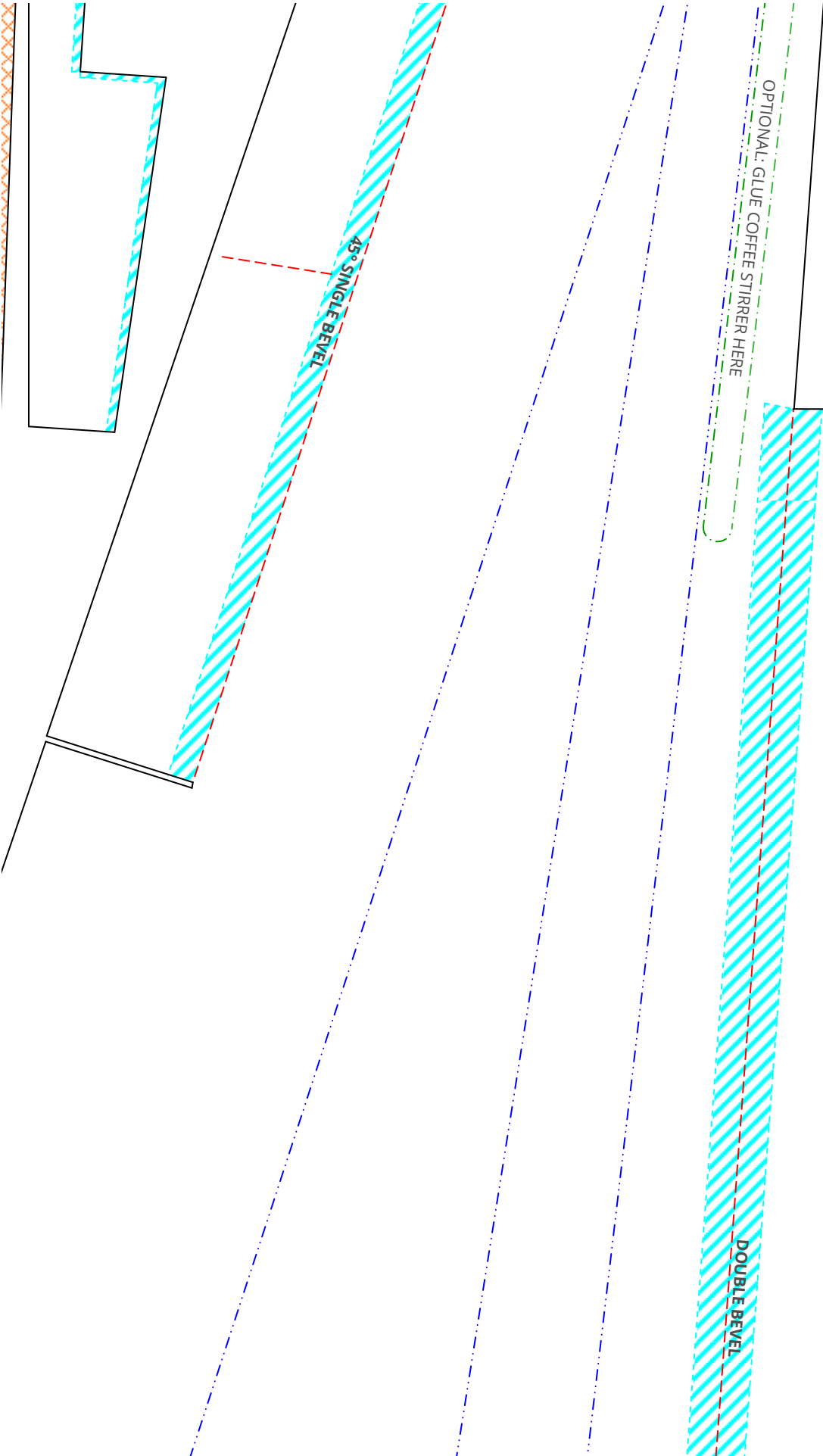

16 VERTICAL STABILIZER
FOAM BOARD
1 AP SUPER TUCANO - VERSION 0.4

45° SINGLE BEVEL

14 ELEVATOR COMBINER
STEEL WIRE Ø 1mm | 0.04in
1 AP SUPER TUCANO - VERSION 0.4

GLUE PART 12 HERE

GLUE PART 12 HERE

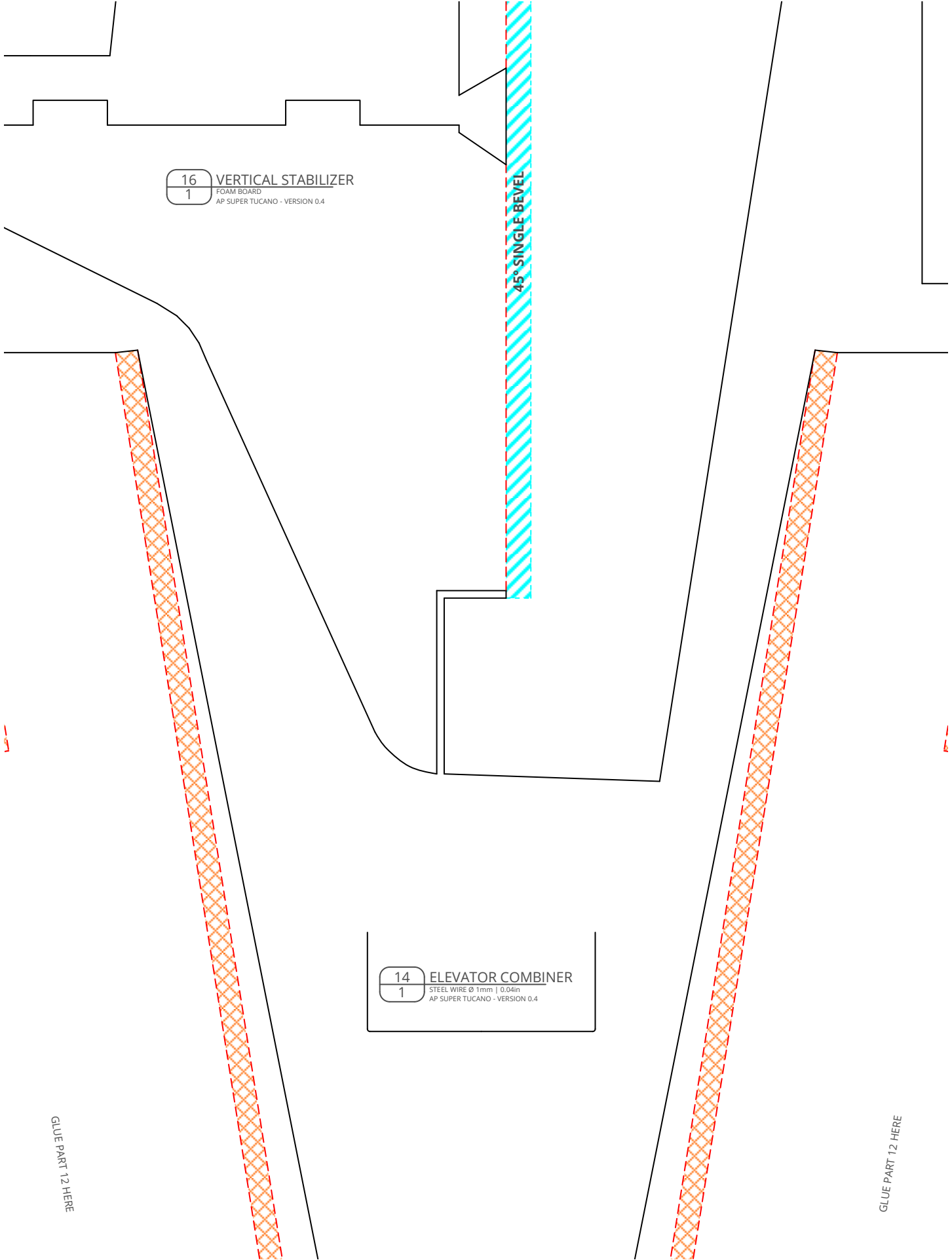

5g SERVO HOLE

9g SERVO HOLE

DOUBLE BEVEL

OPTIONAL: GLUE COFFEE STIRRER HERE

45° SINGLE BEVEL

GLUE PART 11 HERE

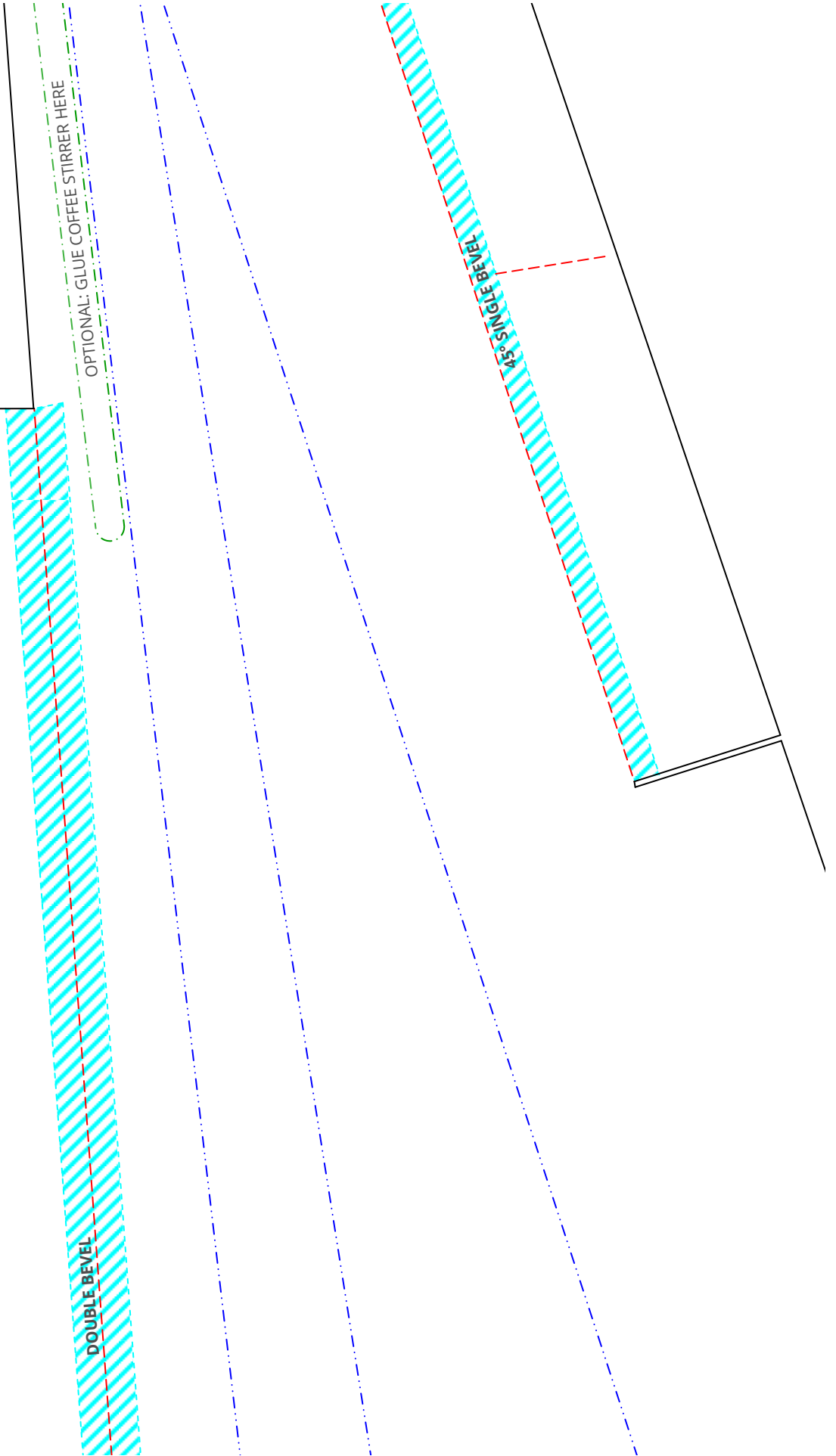

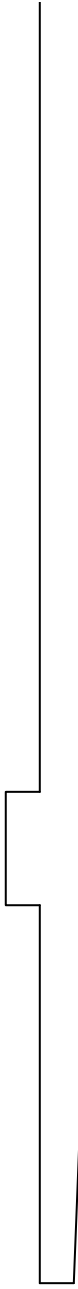
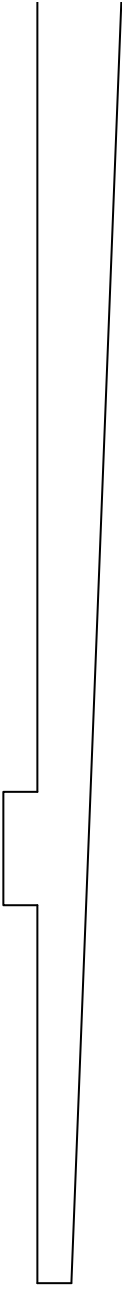
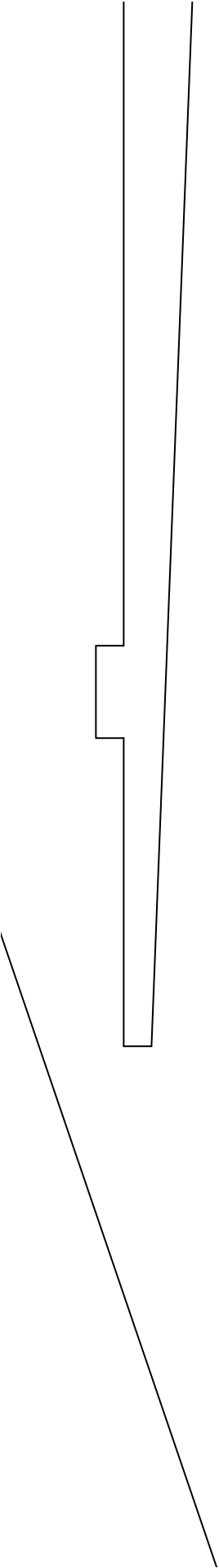

PAR
-VERSION 0.4

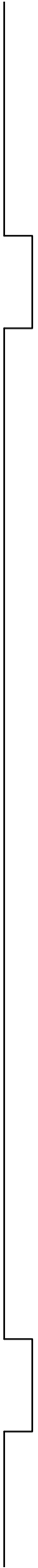

AR
VERSION 0.4



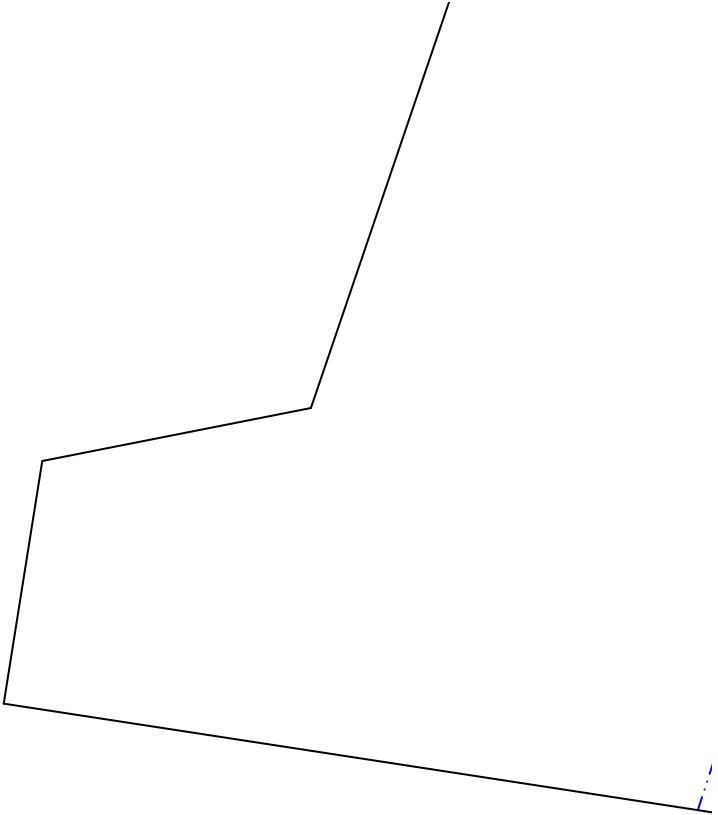

airc-pirates.com

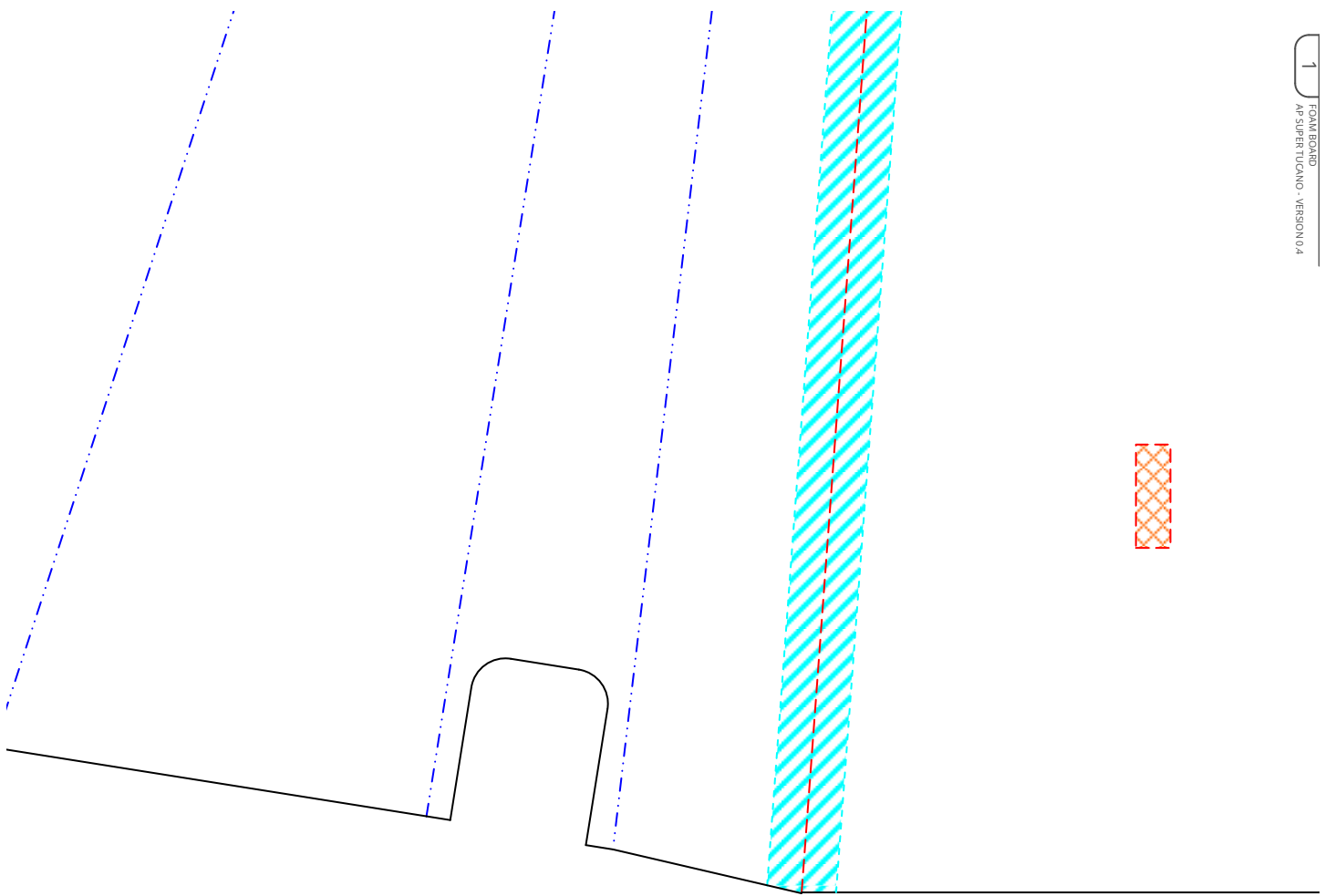

10 RIGHT WING

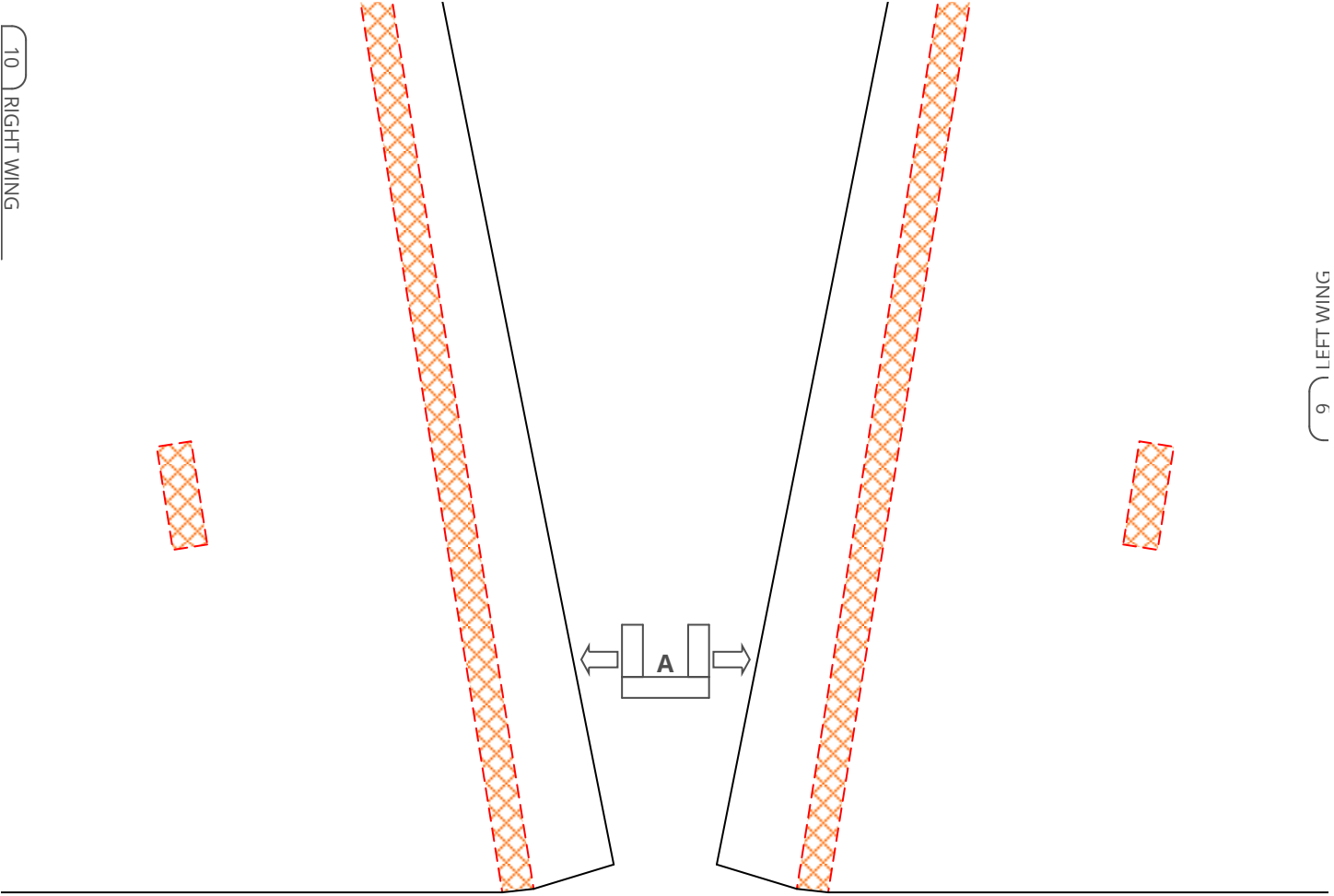

9 LEFT WING

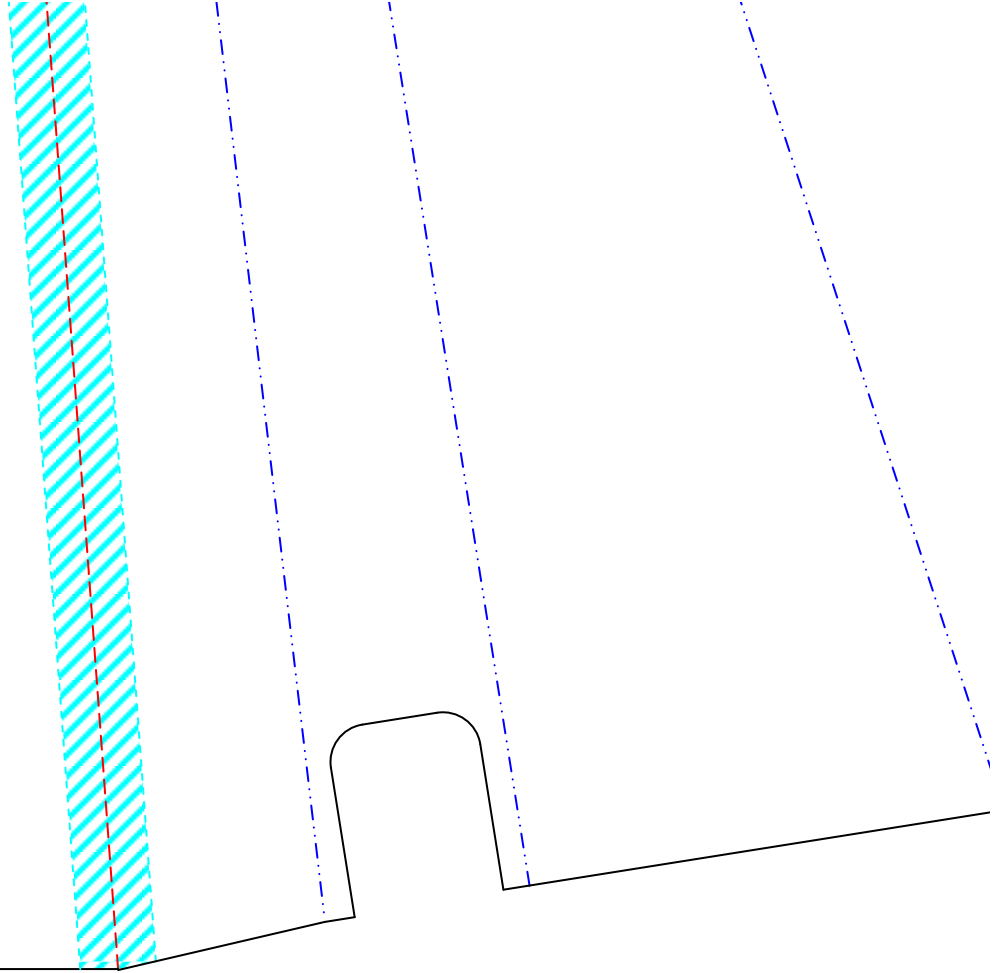
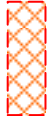



free of charge. Copies allowed for personal use only. Not for commercial use.

