



airc-pirates.com

AP Tachikawa Ki-94-I

... THE FLYING SUMO FIGHTER

Version 0.2 (2018-01-30)

Design & Drawing by: Tony Roehling

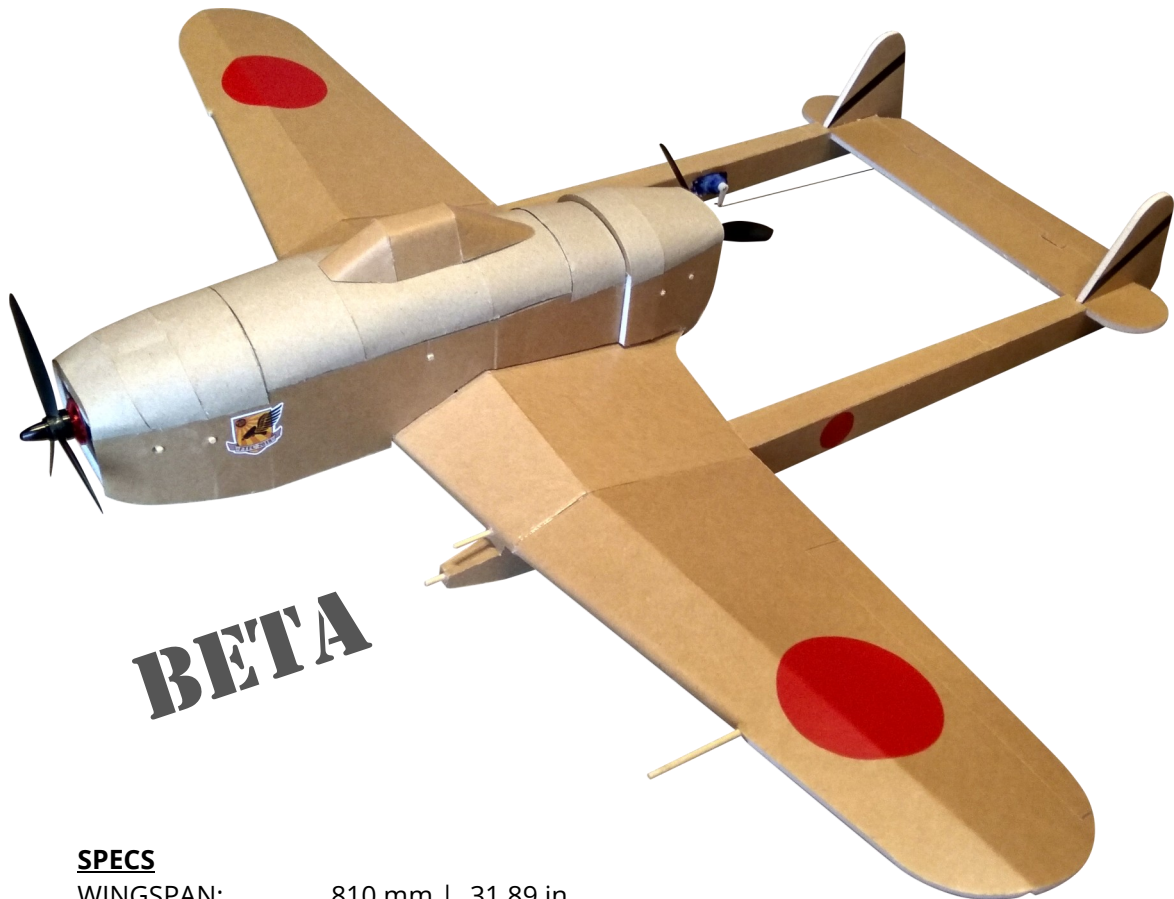

BETA

SPECS

WINGSPAN:	810 mm		31.89 in
CG:	60 mm		2.36 in
LENGTH:	680 mm		26.77 in
DRY WEIGHT:	300 g		10.58 oz
ALL UP WEIGHT:	375 g		13.23 oz (with 3s 1000 mAh)
EXPO:	30 %		
CHANNELS:	3 (THR AIL ELV)		



ELECTRONICS

MOTOR:	2300 kv (1806 or 2204)
PROPELLER:	2 x 5x5 or 6x4 (CW & CCW)
ESC:	2 x 12 A
SERVOS:	3 x 5 g
BATTERY:	1000 mAh 3s



DRAWING KEY

... is based on the Flite Test Drawing Key by Dan Sponholz

FOLD TYPES

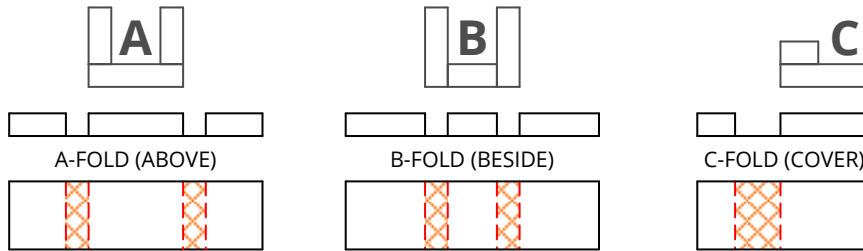

LINE TYPE/COLOR

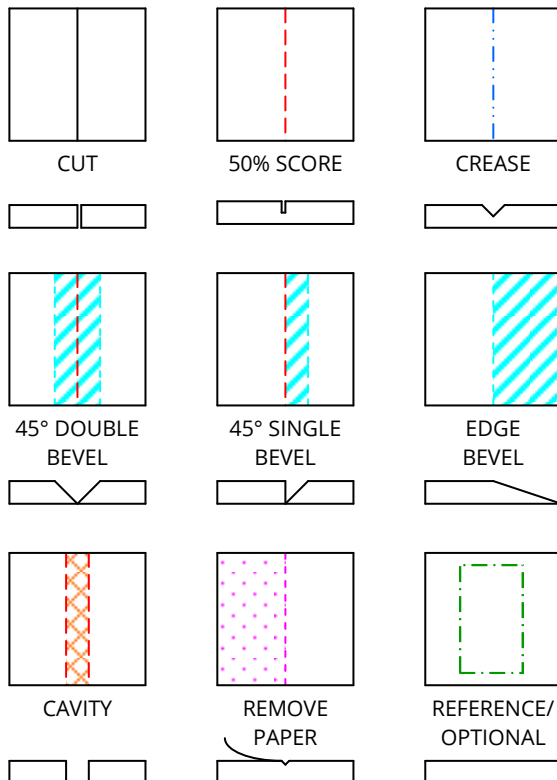

SYMBOLS

PART NUMBER

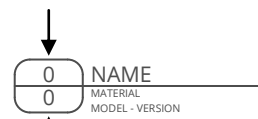

QUANTITY



BETA

AP Tachikawa Ki-94-I PARTS LIST 1/2

Version 0.2 (2018-01-30)

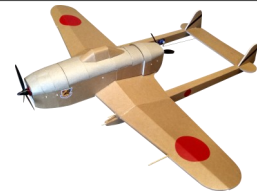

PART NR.	DESCRIPTION	QUANTITY	MATERIAL	SHEET
1	MIDDLE WING	1	FOAM BOARD	1
2	MIDDLE WING SPAR	1	FOAM BOARD	1
3	OUTER WING SPAR	2	FOAM BOARD	1
4	RIGHT WING	1	FOAM BOARD	1
5	LEFT WING	1	FOAM BOARD	1
6	HORIZONTAL STABILIZER	1	FOAM BOARD	1
7	VERTICAL STABILIZER	2	FOAM BOARD	1
8	RIGHT TAIL BOOM	1	FOAM BOARD	2
9	LEFT TAIL BOOM	1	FOAM BOARD	2
10	RIGHT TAIL BOOM SHEETING	1	FOAM BOARD	2
11	LEFT TAIL BOOM SHEETING	1	FOAM BOARD	2
12	FUSELAGE	1	FOAM BOARD	2
13	REAR RIGHT SIDEWALL	1	FOAM BOARD	2
14	REAR LEFT SIDEWALL	1	FOAM BOARD	2
15	FRONT POWER POD SPACER	2	FOAM BOARD	2
16	REAR POWER POD SPACER	2	FOAM BOARD	2
17	LOWER FRONT SHEETING	1	FOAM BOARD	2
18	LOWER REAR SHEETING	1	FOAM BOARD	2
19	FORMER A	1	FOAM BOARD	2
20	FORMER B	1	FOAM BOARD	2
21	FORMER C	1	FOAM BOARD	2
22	FORMER D	1	FOAM BOARD	2
23	FORMER E	1	FOAM BOARD	2
24	FORMER F	1	FOAM BOARD	2
25	ELECTRONICS BAY SHEETING	1	FOAM BOARD	2
26	FORMER G	1	FOAM BOARD	2
27	FORMER H	1	FOAM BOARD	2
28	ELECTRONICS BAY PIN	2	FOAM BOARD	2
29	FRONT TURTLE DECK	1	POSTER BOARD	3
30	ELECTRONICS BAY TURTLE DECK	1	POSTER BOARD	3
31	MIDDLE TURTLE DECK	1	POSTER BOARD	3
32	REAR TURTLE DECK	1	POSTER BOARD	3
33	CANOPY	1	FOAM BOARD	2
34	MINI POWER POD	2	FOAM BOARD	2
35	MINI FIREWALL	2	PLYWOOD max. 5mm	3

Build the Ki-94-I in the order of the part numbers!

BETA

AP Tachikawa Ki-94-I PARTS LIST 2/2

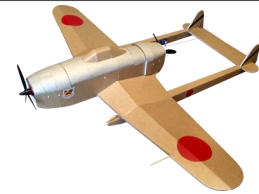

Version 0.2 (2018-01-30)

PART NR.	DESCRIPTION	QUANTITY	MATERIAL	SHEET
36	CONTROL HORN	3	PLASTIC CARD	3
37	CANOPY MOUNT PIN	1	BBQ SKEWER	3
38	POWER POD MOUNT PIN	4	BBQ SKEWER	3
39	LOWER GUNS	2	BBQ SKEWER	3
40	UPPER GUNS	2	BBQ SKEWER	3
41	ANTENNA	1	BBQ SKEWER	3
G1	DIHEDRAL GAUGE	1	FOAM BOARD	1
G2	90° TRIANGLE	1	FOAM BOARD	2
G3	THROW GAUGE	1	FOAM BOARD	2
	OTHER MATERIALS			
	STEEL WIRE (Ø 1mm) FOR THE LINKAGE RODS			
	VELCRO TO MOUNT THE BATTERY, ESC, ...			

Hints:

You need counter-rotating propellers (CW & CCW) and a Y-Power-Cable to connect the two ESCs with the battery.

Please do not forget to remove the red cable from the signal cable at one ESC, bend it back and fix it with some tape. You have to do this for every Twin model using two ESCs!

Build the Ki-94-I in the order of the part numbers!

AP Tachikawa Ki

Design & Drawing by: Tony Roehling

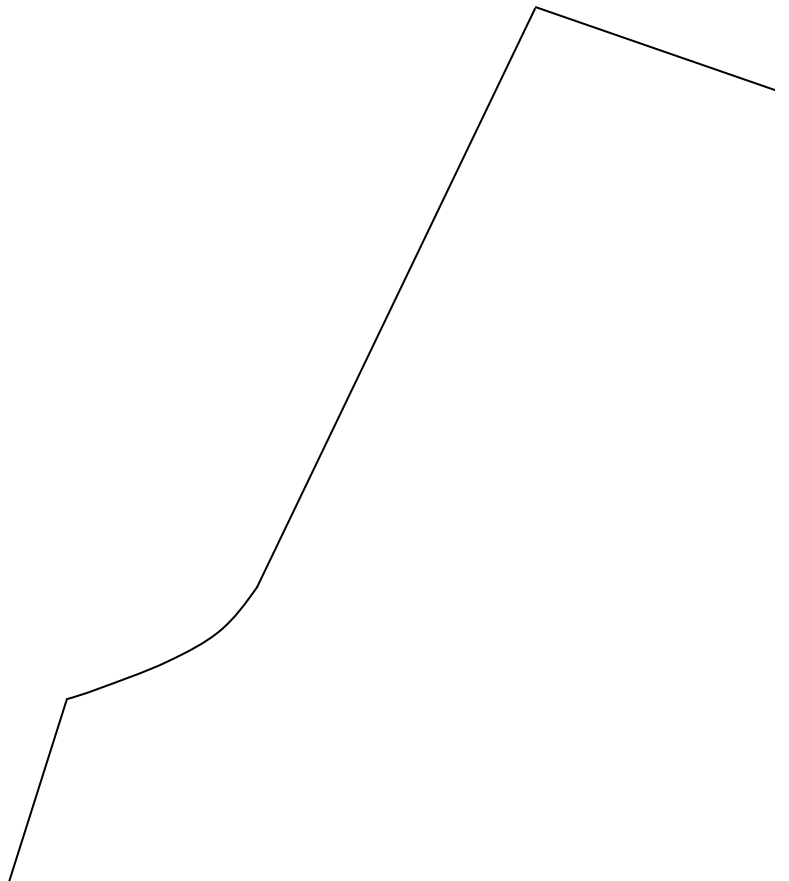

i-94-1 ... THE FLYING SUMO FIGHTER - VEI

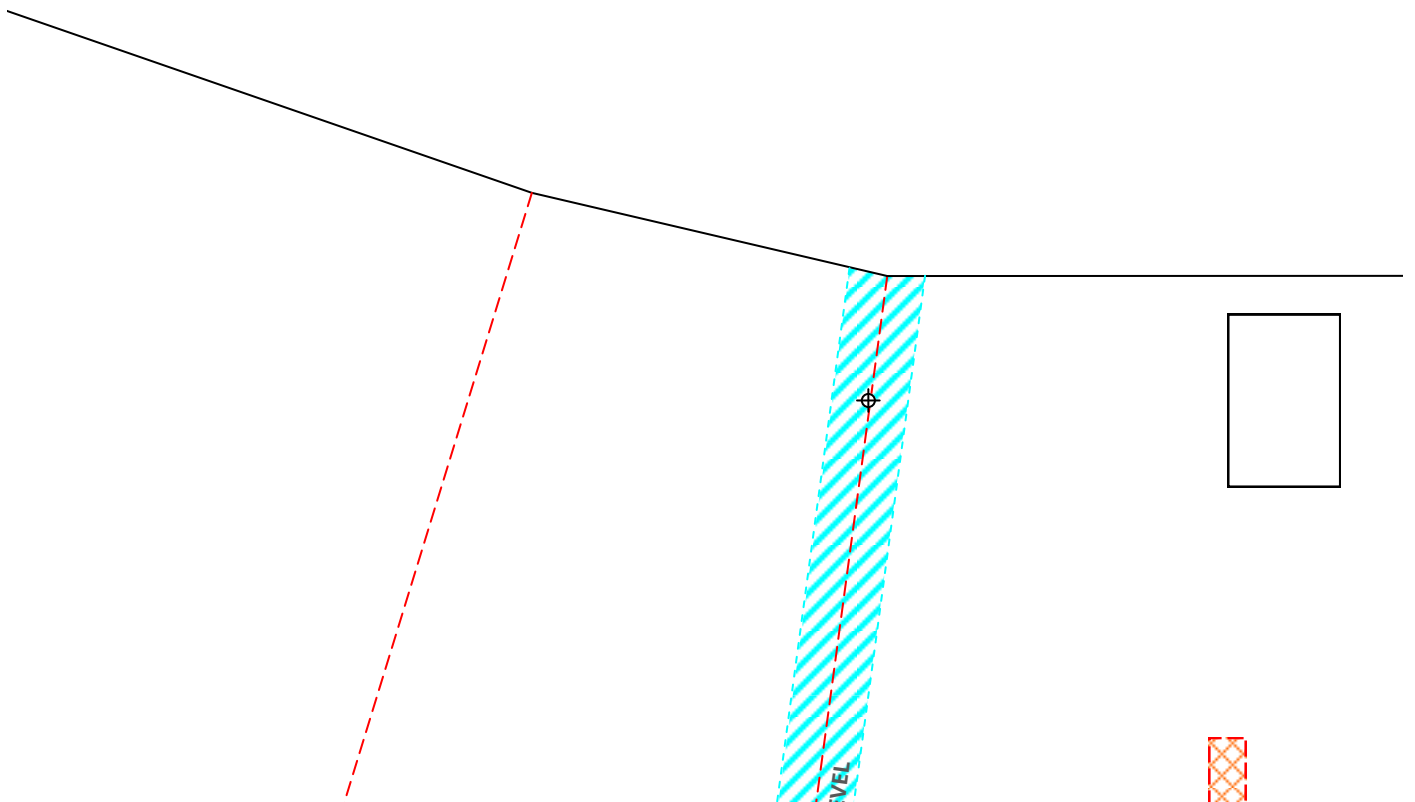

VERSION 0.2 (2018-01-30)

G1	DIHEDRAL GAUGE
1	FOAM BOARD
	AP KI-94-1 - VERSION 0.2

→ up

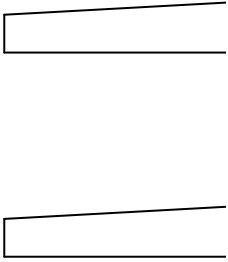
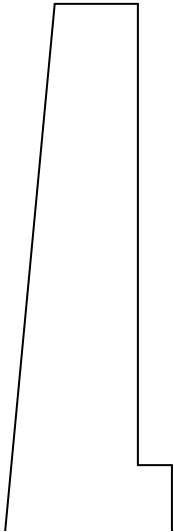
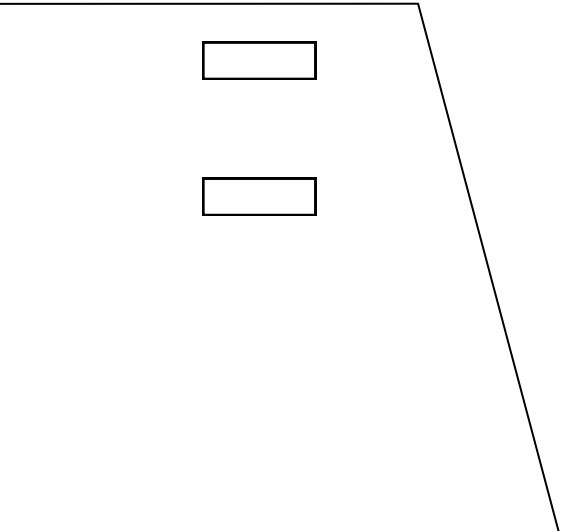

in
cm

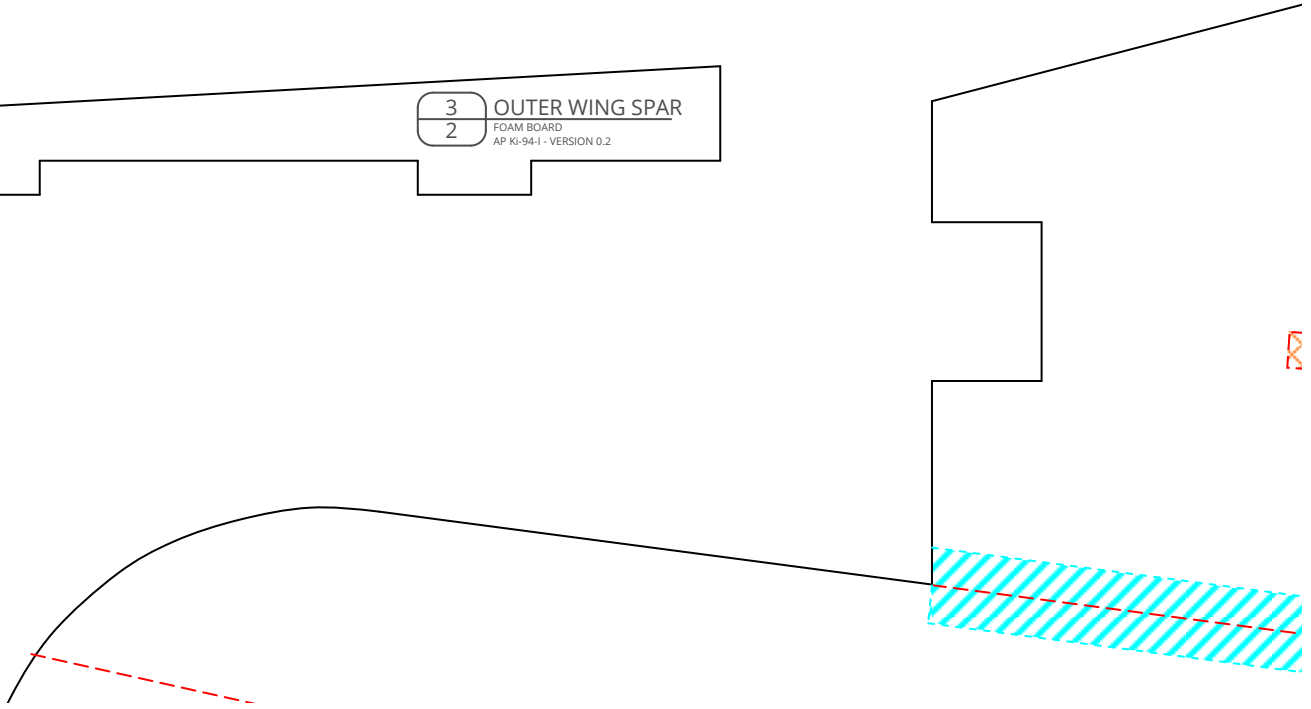
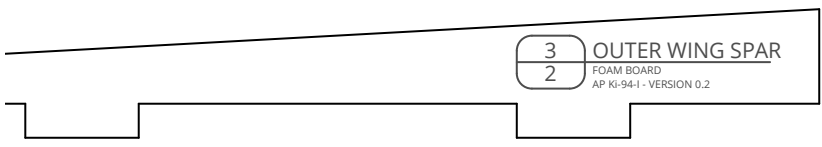
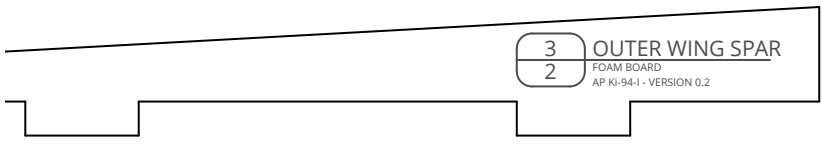



SHEET 1 OF 3

5 LEFT WING
1 FOAM BOARD
AP Ki-94-1 - VERSION 0.2

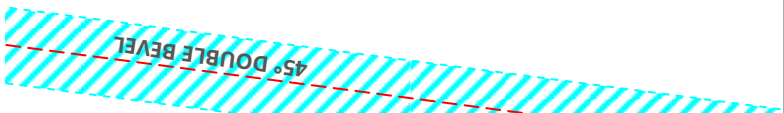

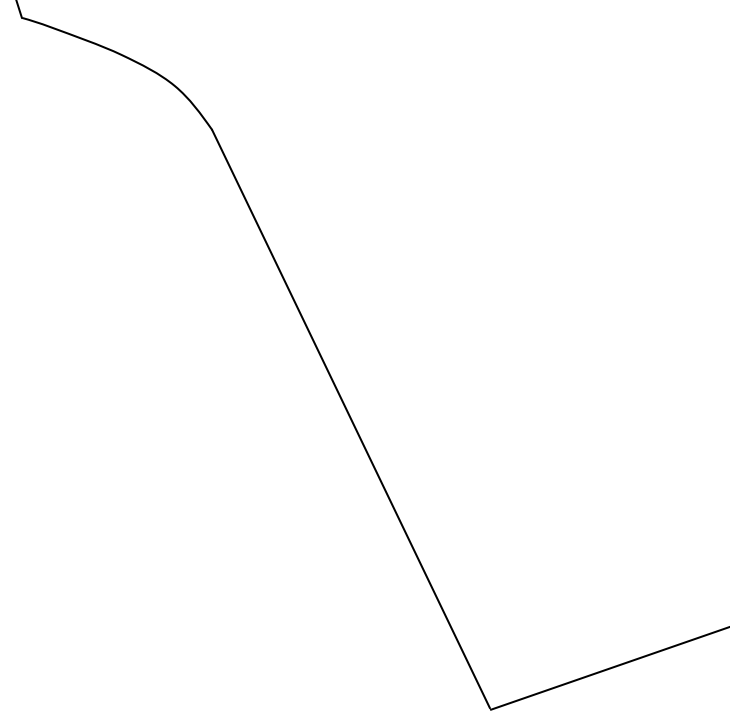
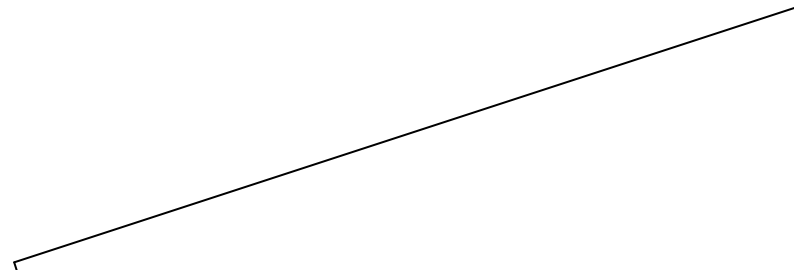
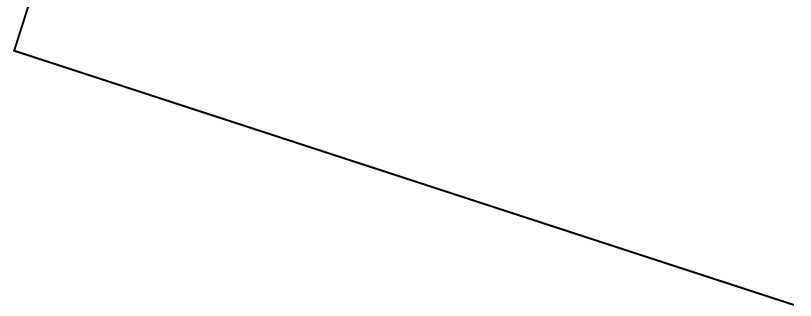

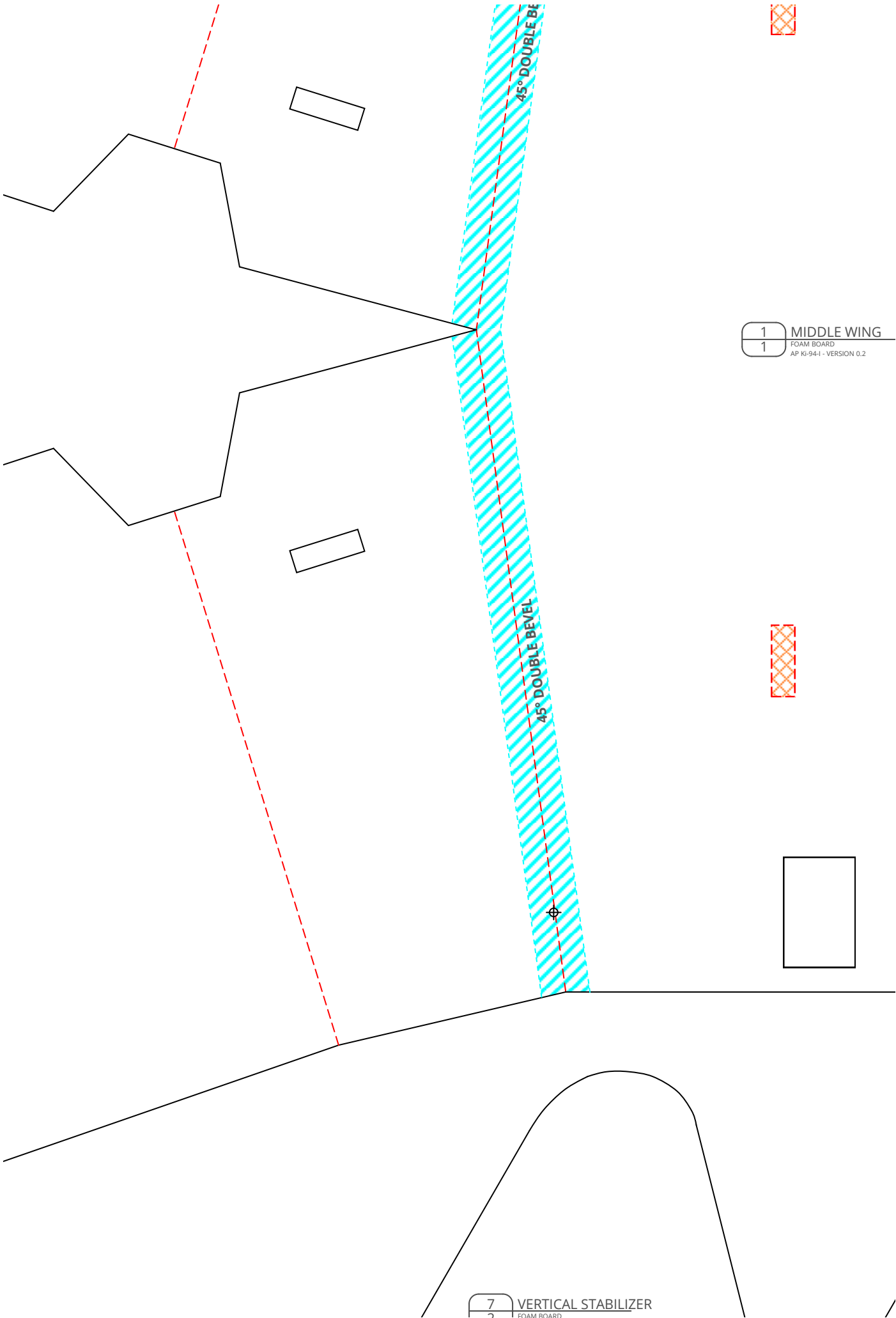

1 MIDDLE WING
1 FOAM BOARD
AP-KI-94-1 - VERSION 0.2

7 VERTICAL STABILIZER
FOAM BOARD

1

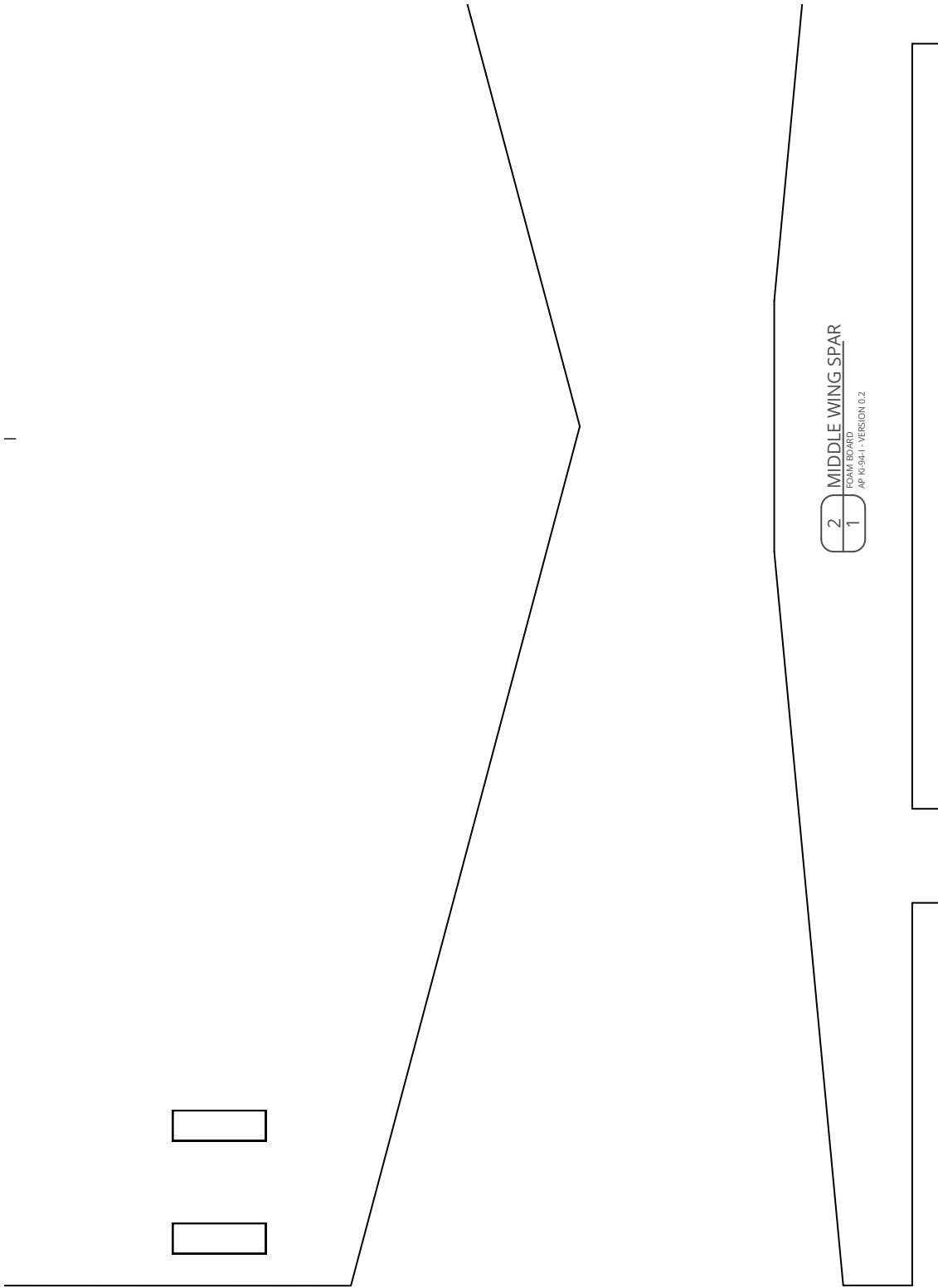

2 MIDDLE WING SPAR
FOAM BOARD
AP N-941 - VERSION 0.2

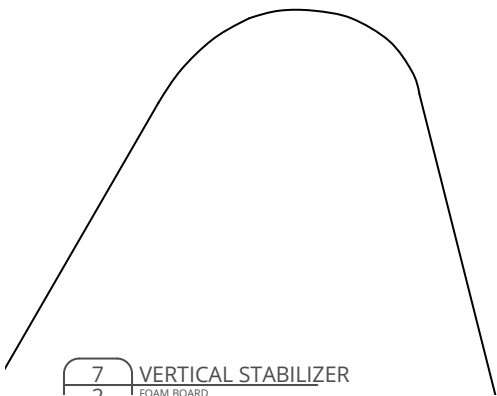

7 VERTICAL STABILIZER
FOAM BOARD

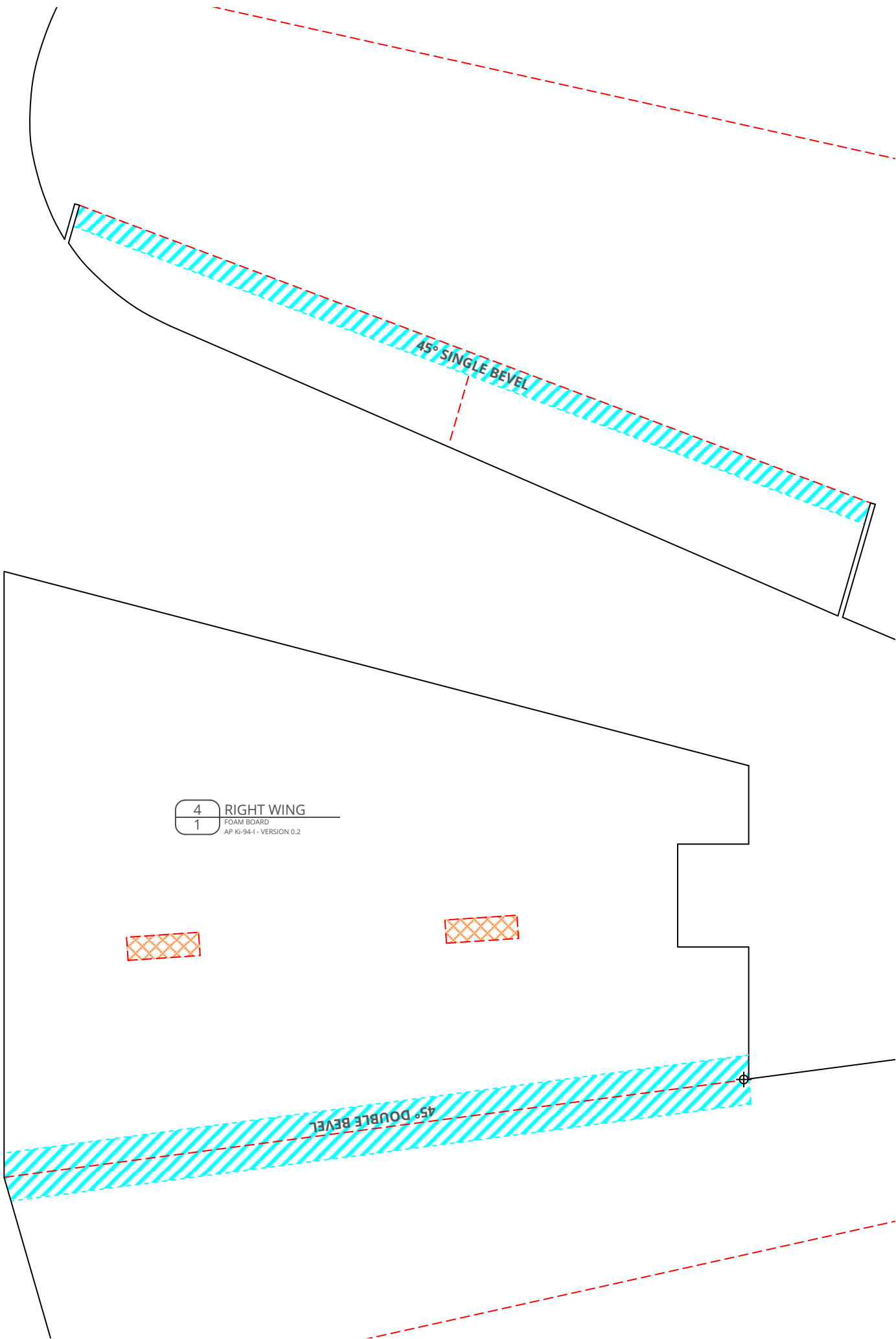

4 RIGHT WING
1 FOAM BOARD
AP KI-94-1 - VERSION 0.2

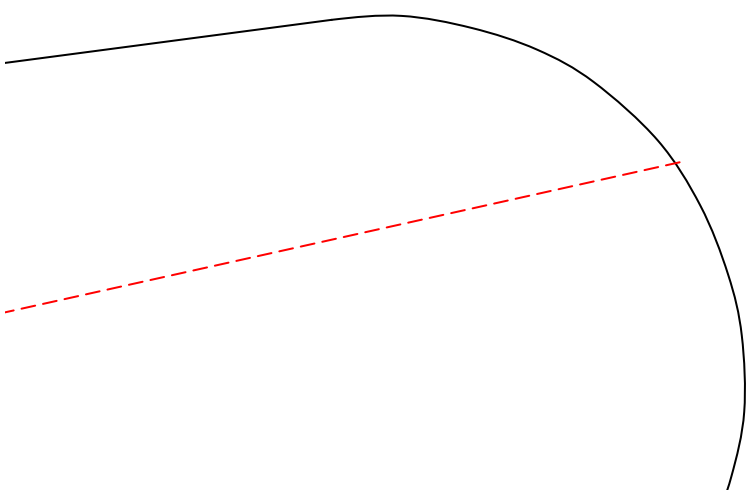
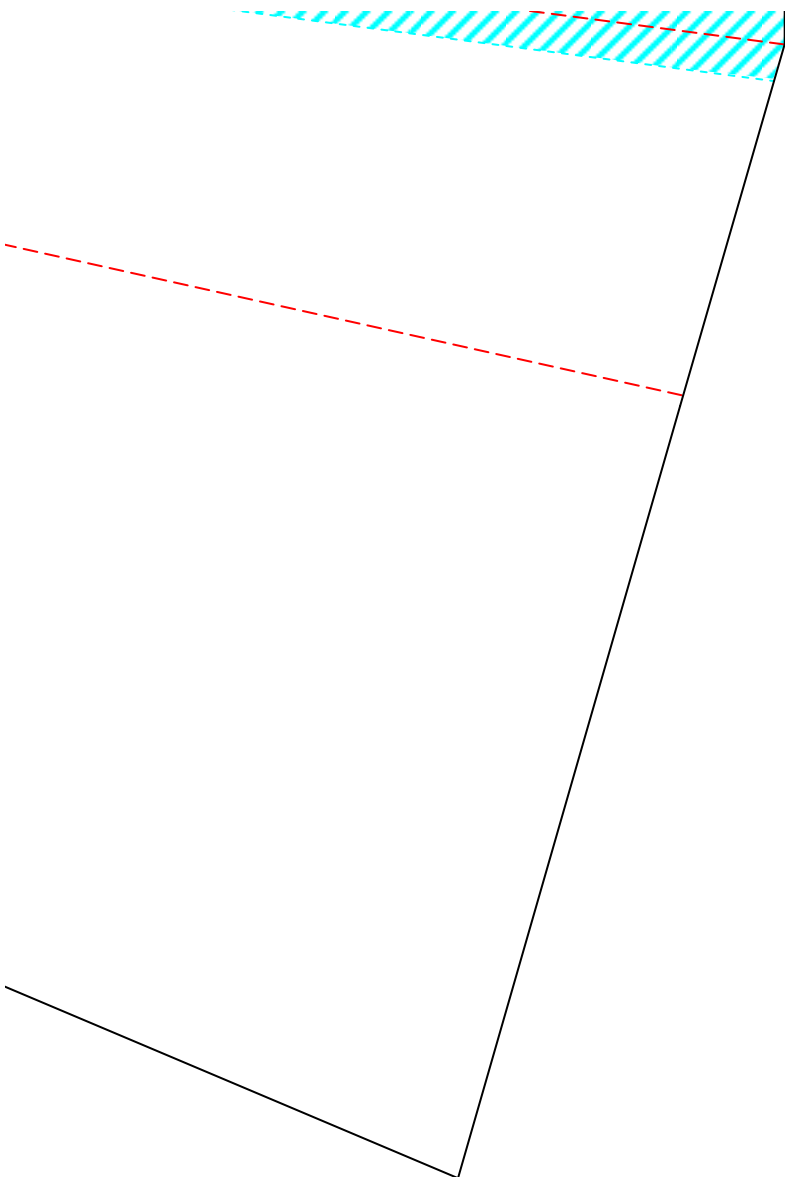

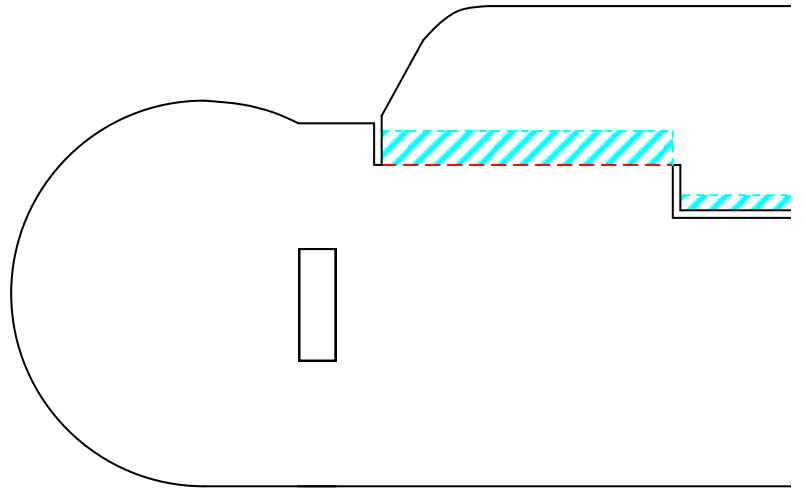

airc-pirates.com

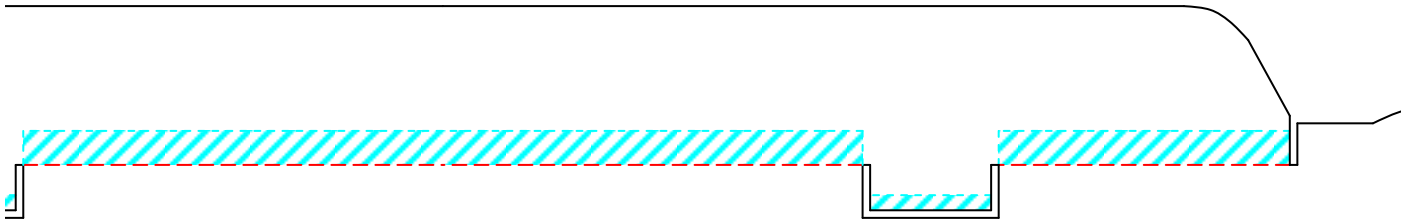
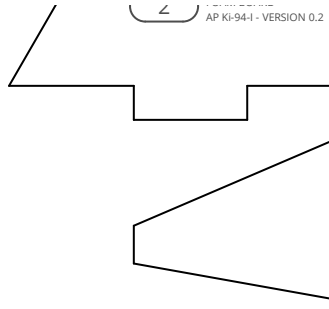

6 HORIZONTAL STABILIZER
1 FOAM BOARD
AP KI-94-1 - VERSION 0.2

BETA

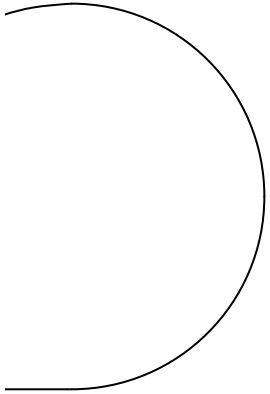

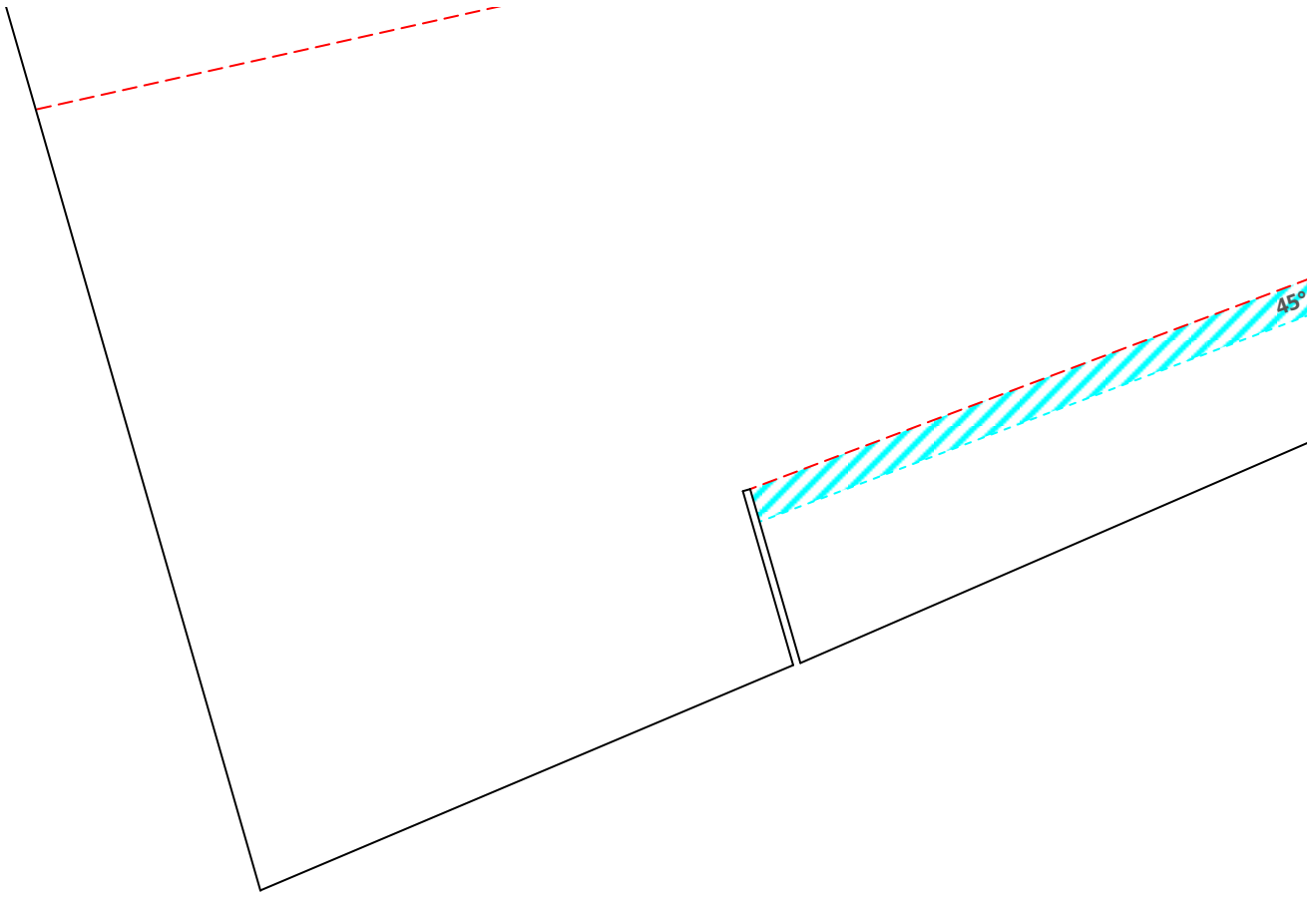

USE.

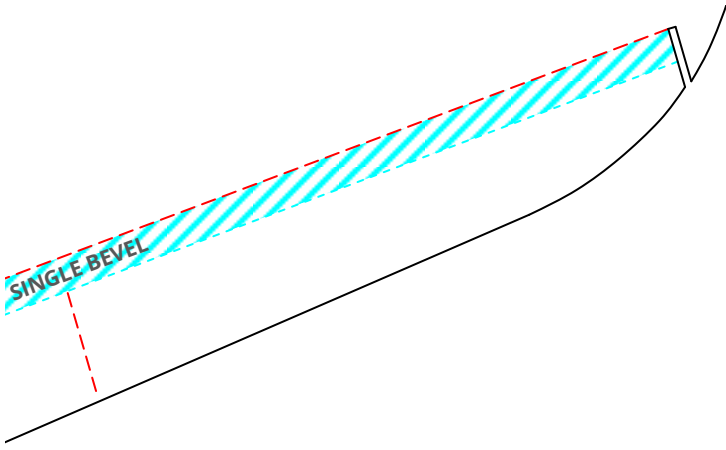

AP Tachikawa Ki

Design & Drawing by: Tony Roehling

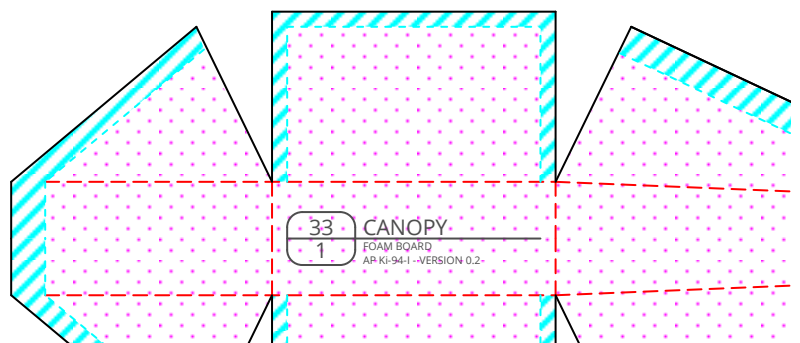
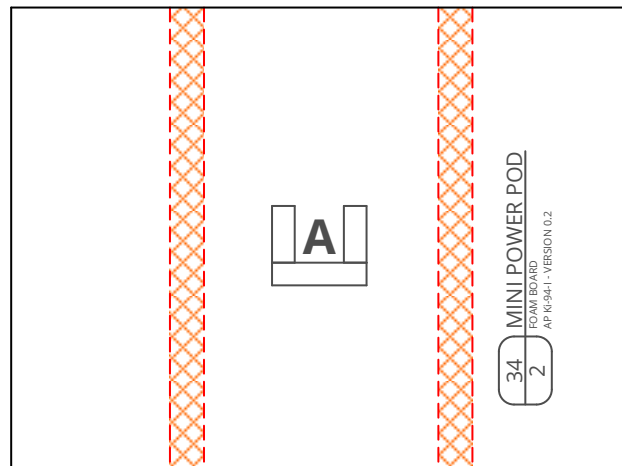

i-94-1 ... THE FLYING SUMO FIGHTER - VEI

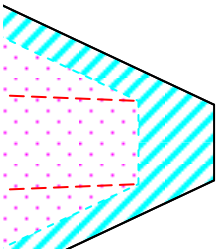
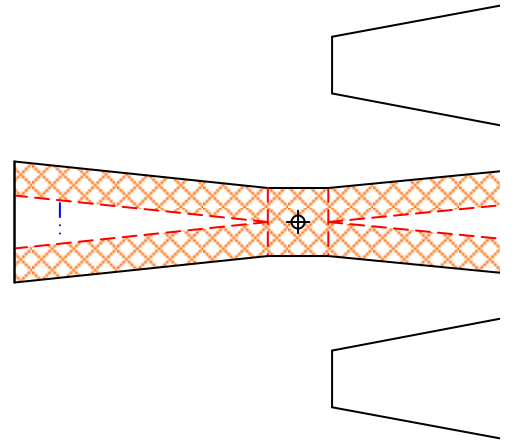
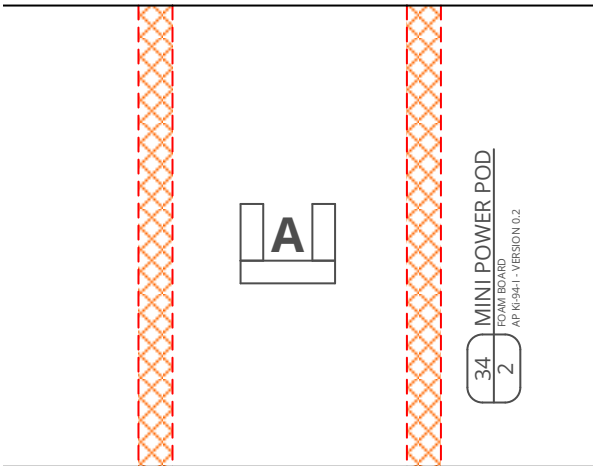

BETA

VERSION 0.2 (2018-01-30)

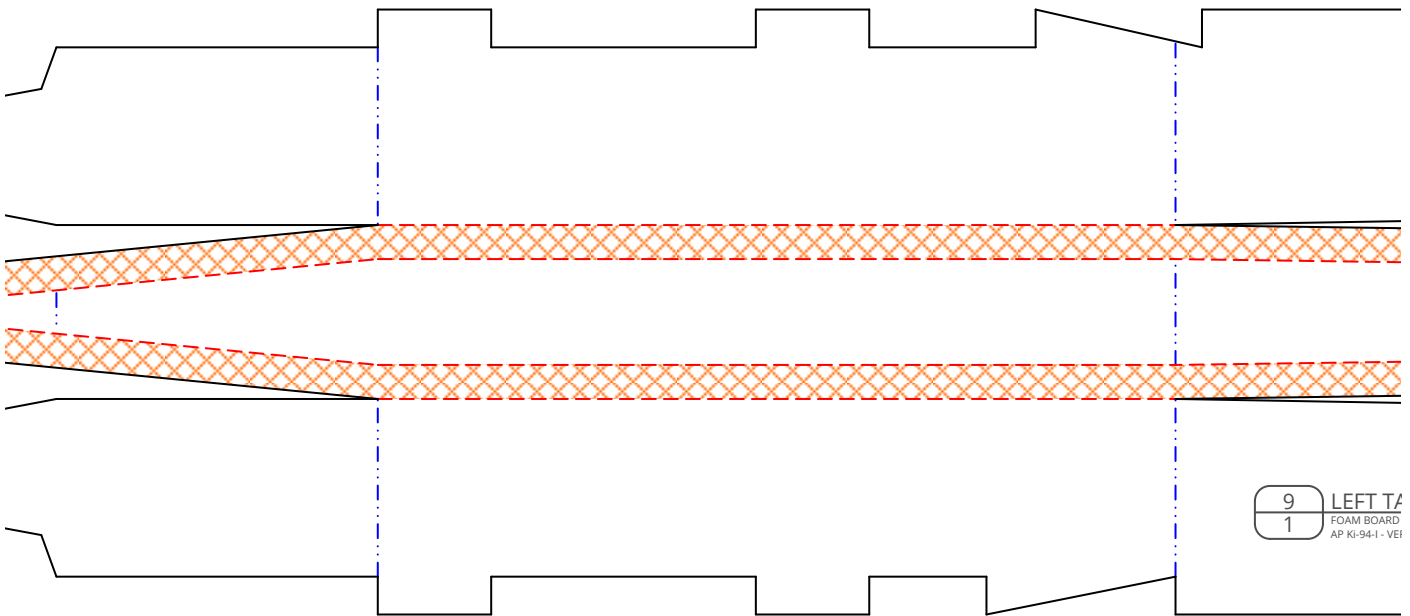

9
1 LEFT TAIL
FOAM BOARD
AP KI-94-I - VER1

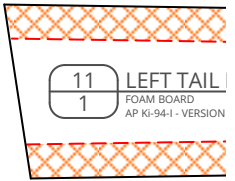

11
1 LEFT TAIL
FOAM BOARD
AP KI-94-I - VERSION

in

cm

WALL BOOM

VERSION 0.2

BOOM SHEETING

0.2



SHEET 2 OF 3

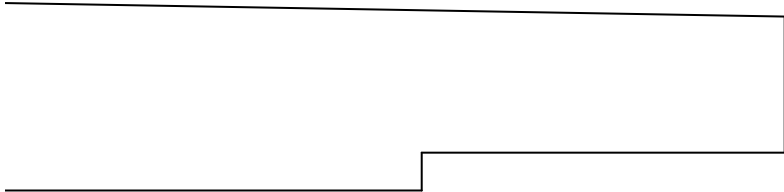
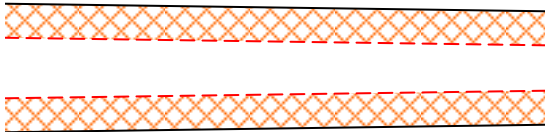
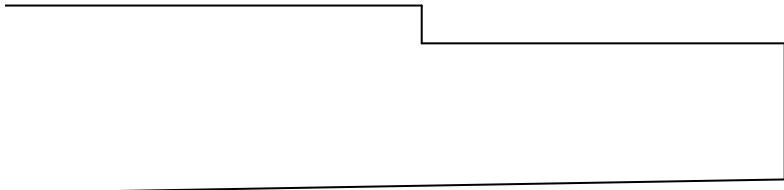

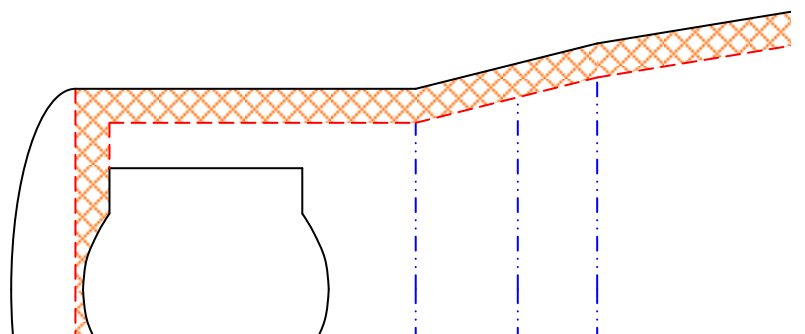
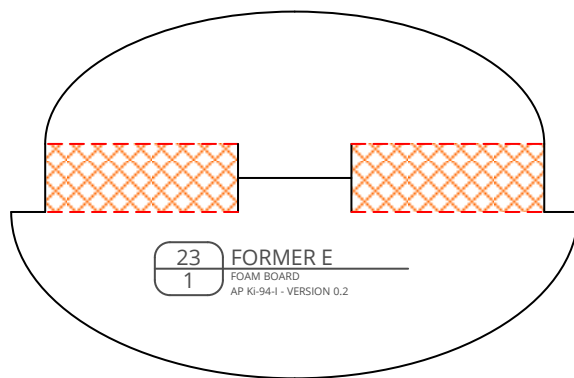
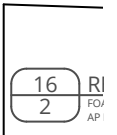
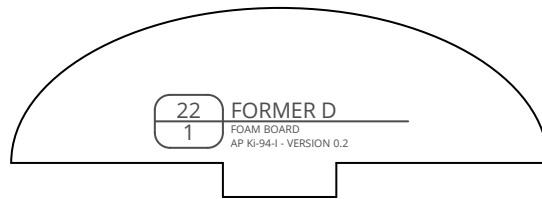
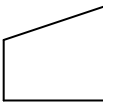
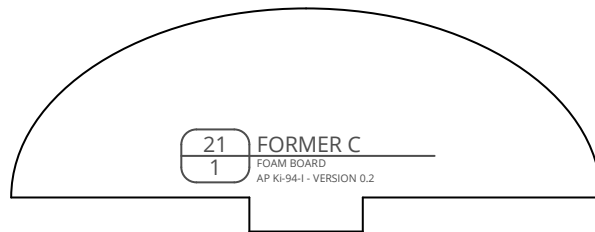
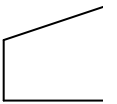
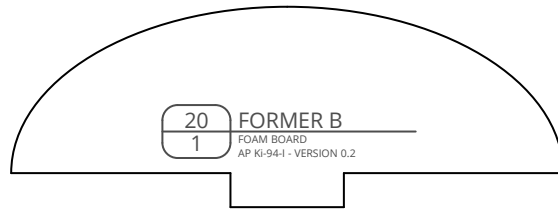
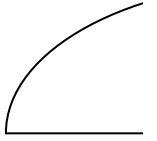
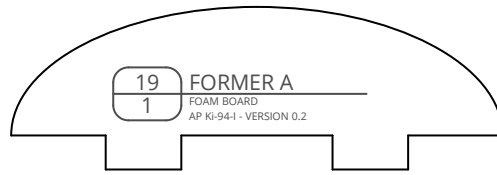
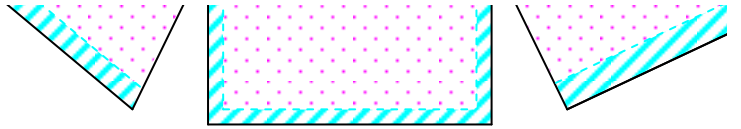

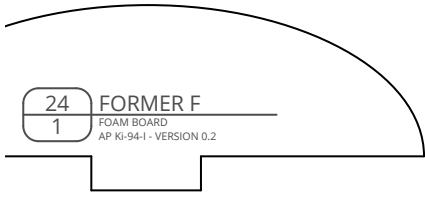

24 FORMER F
FOAM BOARD
AP Ki-94-I - VERSION 0.2

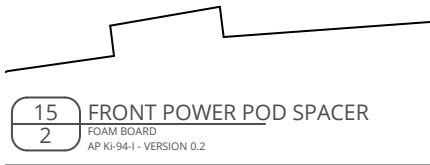

15 FRONT POWER POD SPACER
FOAM BOARD
AP Ki-94-I - VERSION 0.2



15 FRONT POWER POD SPACER
FOAM BOARD
AP Ki-94-I - VERSION 0.2

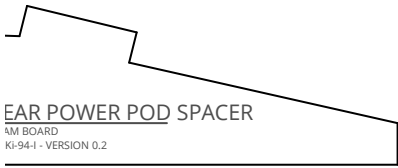

EAR POWER POD SPACER
4M BOARD
Ki-94-I - VERSION 0.2

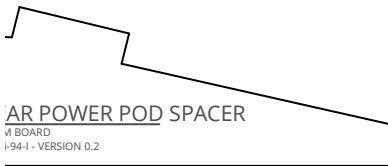

AR POWER POD SPACER
4M BOARD
Ki-94-I - VERSION 0.2

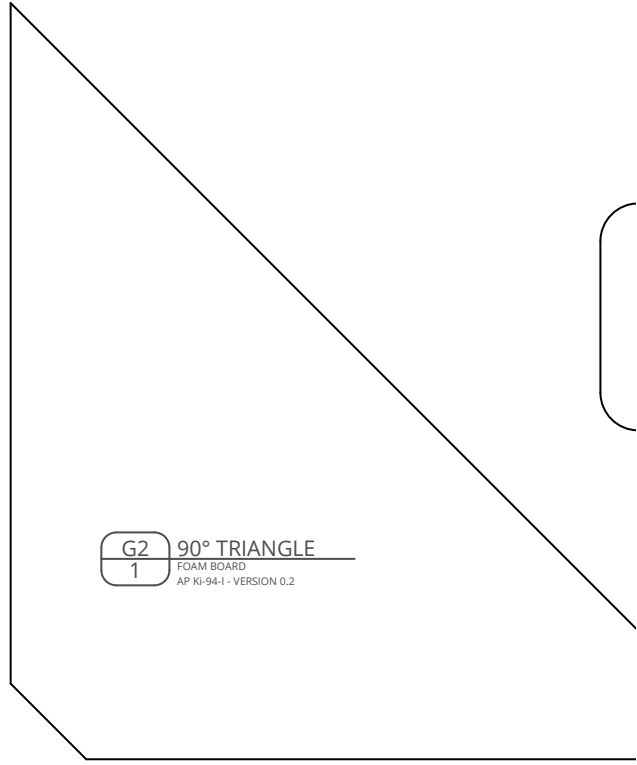

G2 90° TRIANGLE
FOAM BOARD
AP Ki-94-I - VERSION 0.2

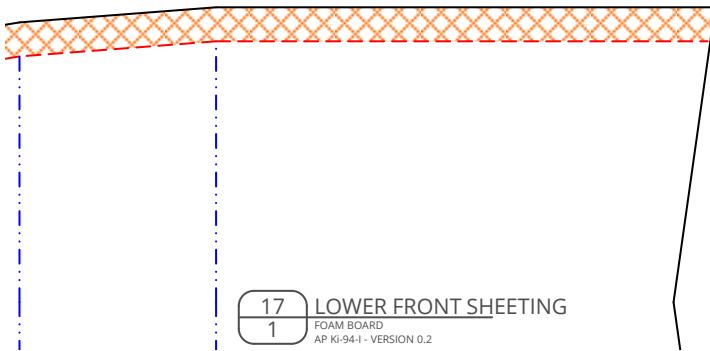
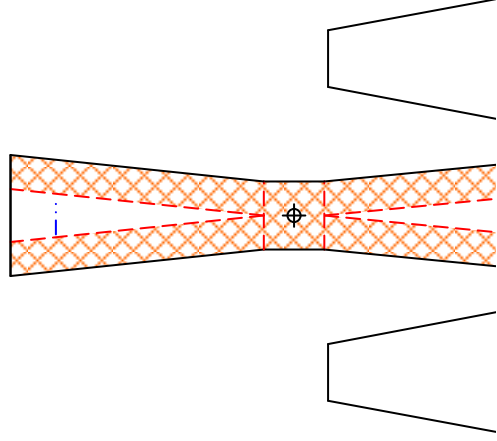

17 LOWER FRONT SHEETING
FOAM BOARD
AP Ki-94-I - VERSION 0.2

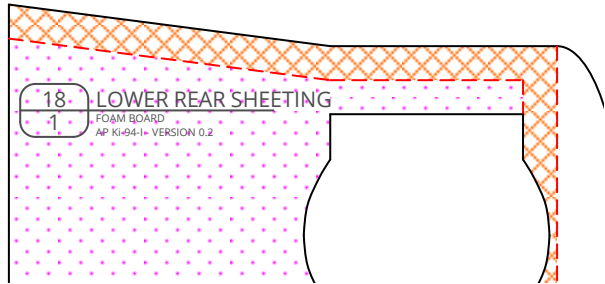

18 LOWER REAR SHEETING
FOAM BOARD
AP Ki-94-I - VERSION 0.2

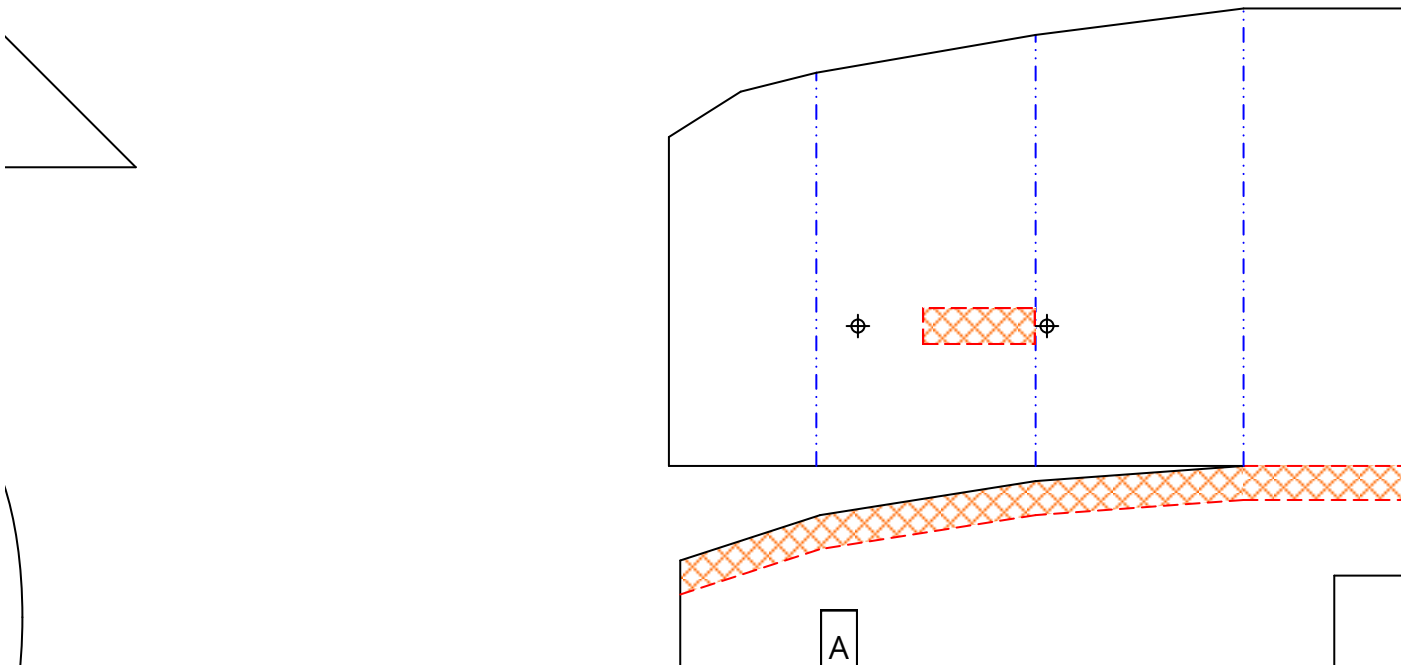
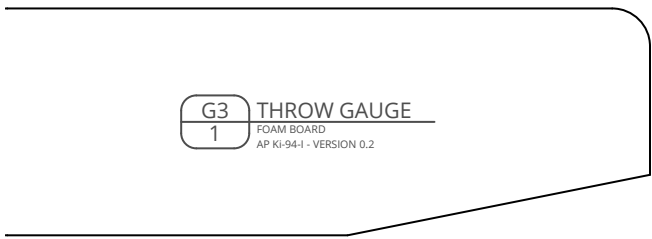
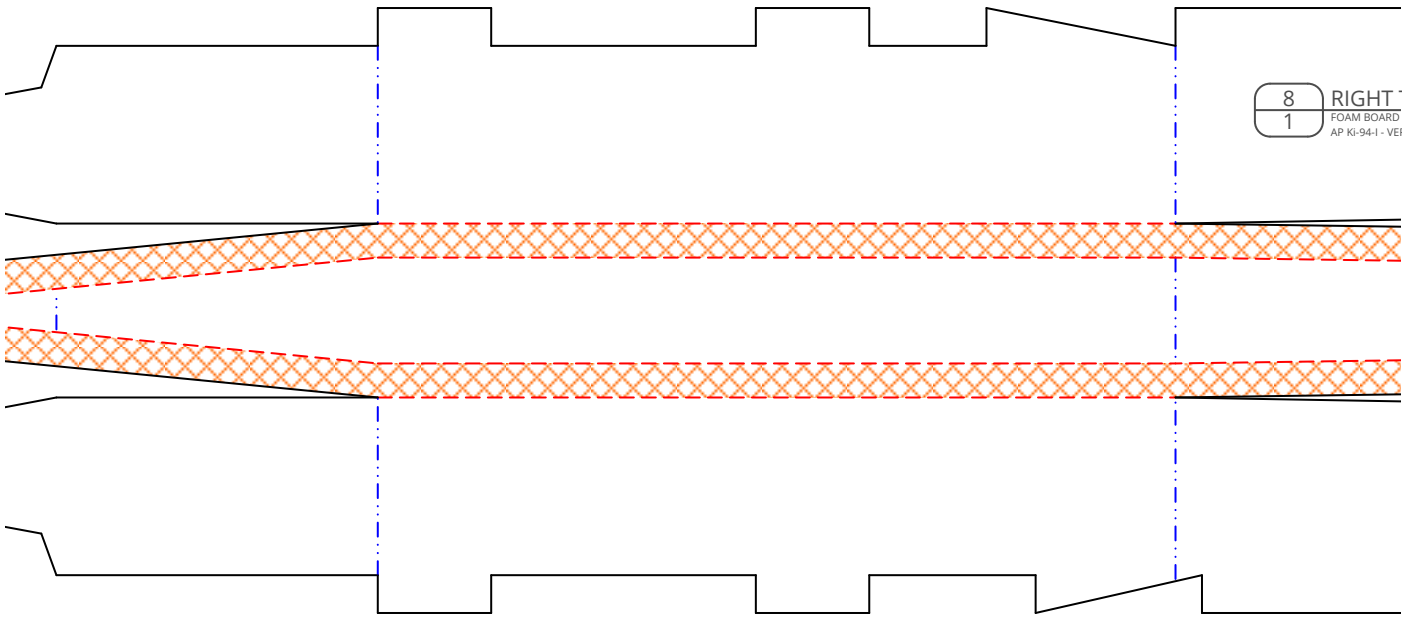
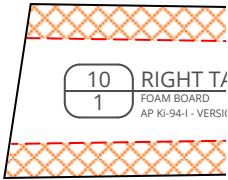

TAIL BOOM SHEETING

VERSION 0.2

TAIL BOOM

VERSION 0.2

HOLE FOR
HXT 500 SERVO



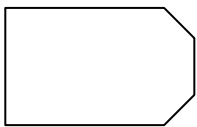
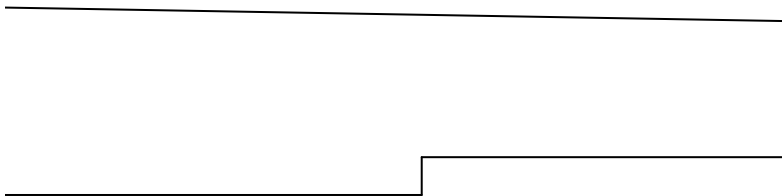
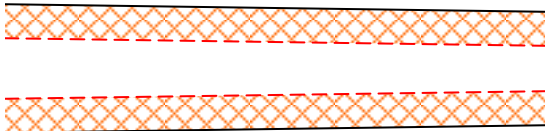
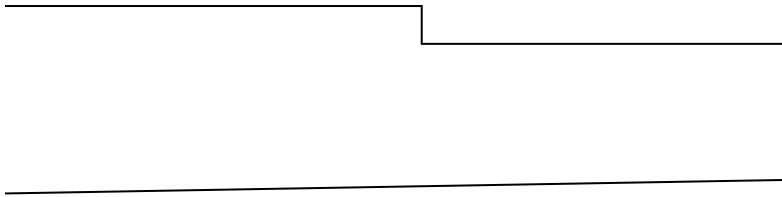
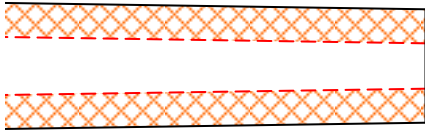

28 ELECTRONICS BAY PIN
FOAM BOARD
2 AP KI-94-1 - VERSION 0.2

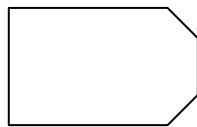

28 ELECTRONICS BAY PIN
FOAM BOARD
2 AP KI-94-1 - VERSION 0.2

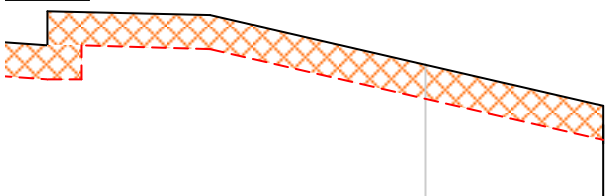
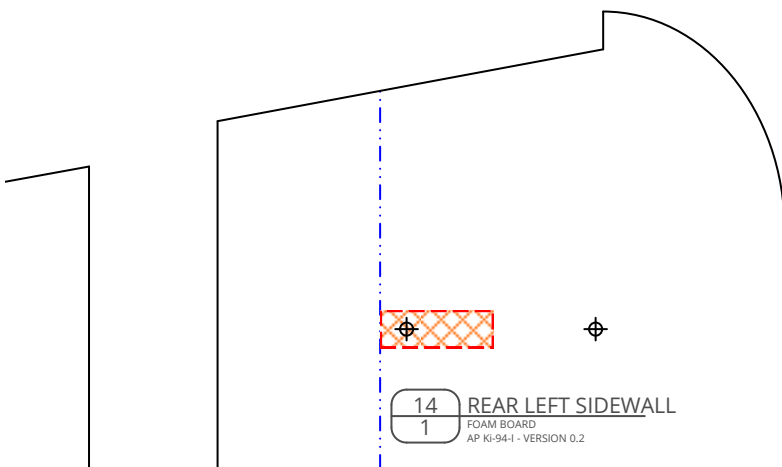

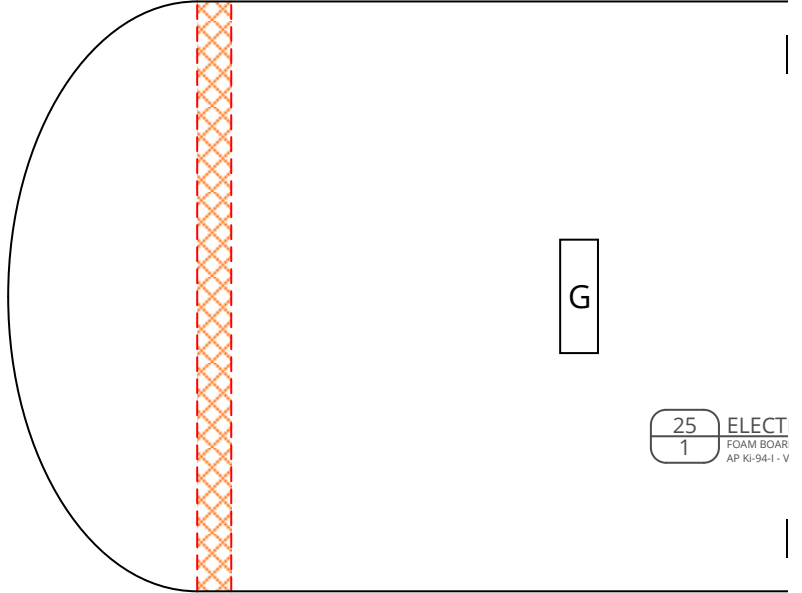
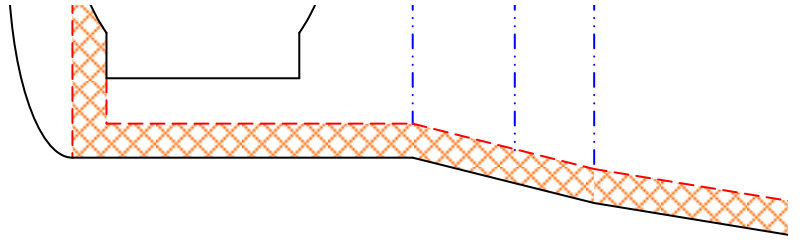

25 ELECT
1 FOAM BOARD
AP KI-94-I-V



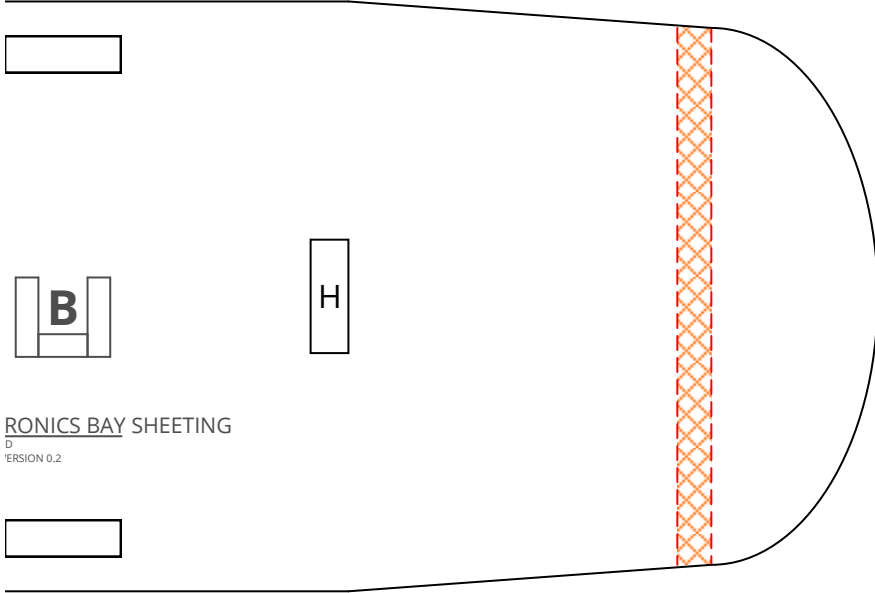
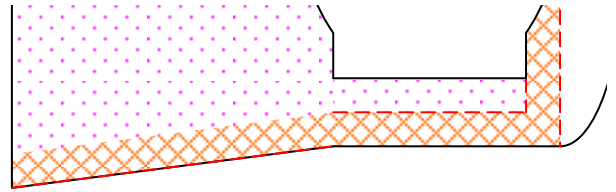
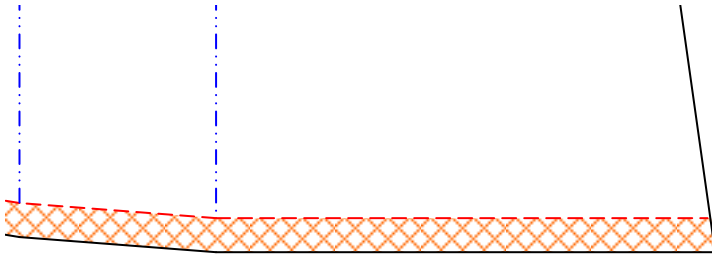

RONICS BAY SHEETING
D
VERSION 0.2

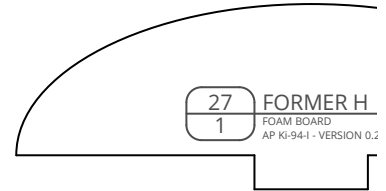
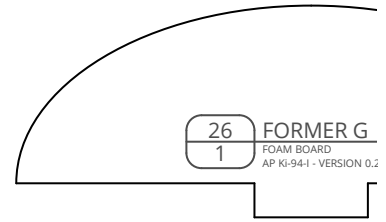

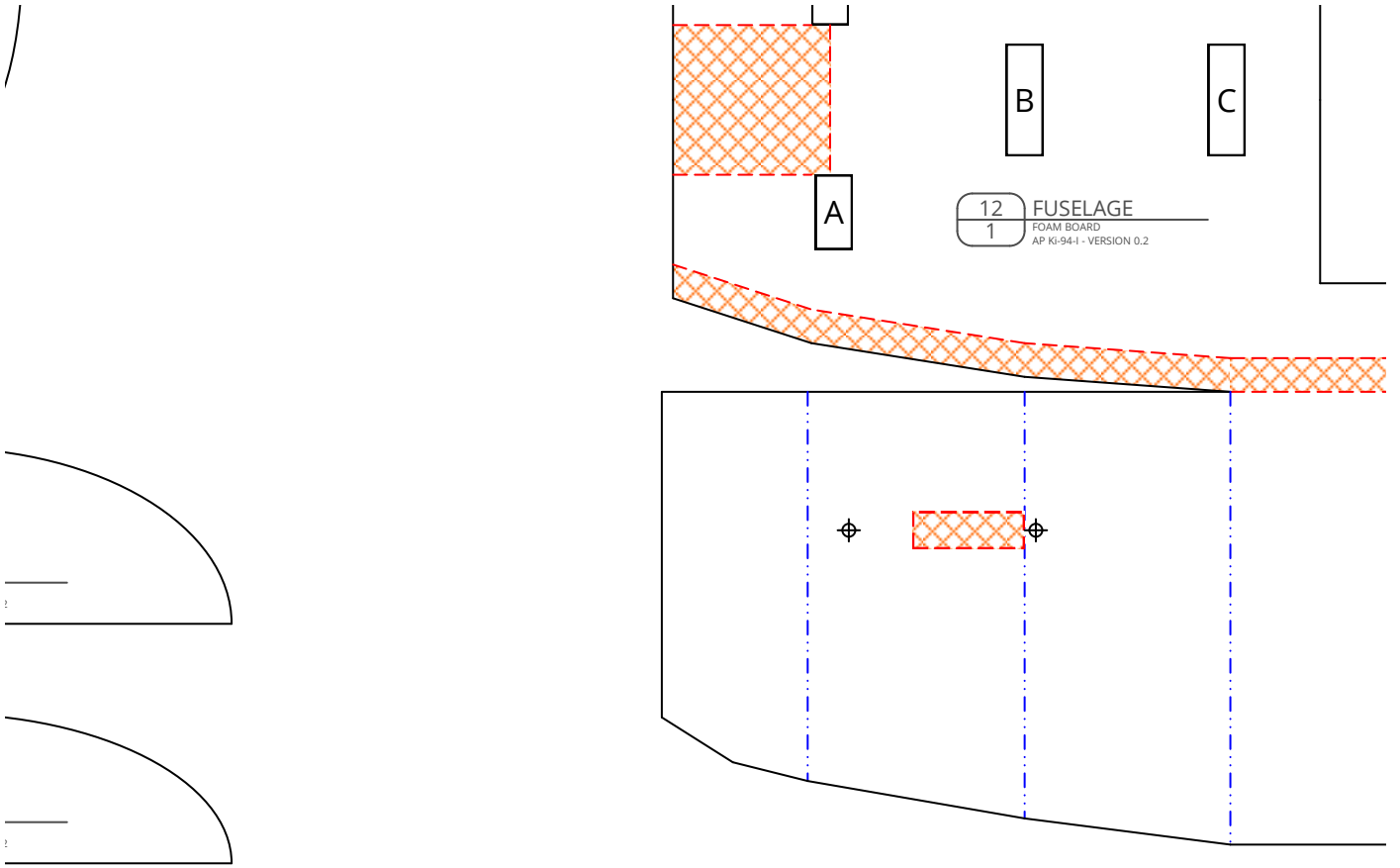

Right © 2017 Airc Pirates. Plans provided free of charge. Copies allowed for personal use only. Not for commercial

D

B

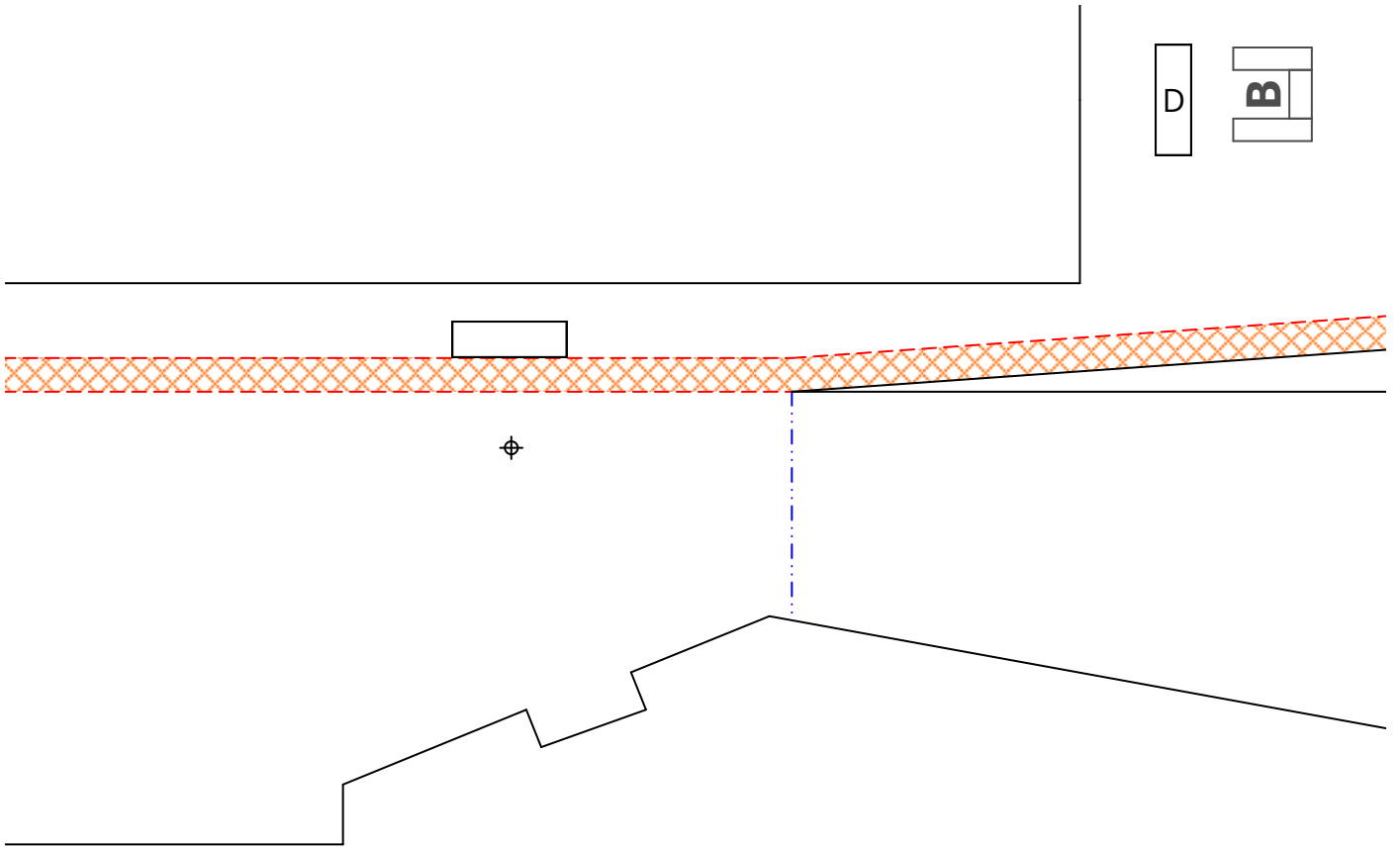

USE.

E

F

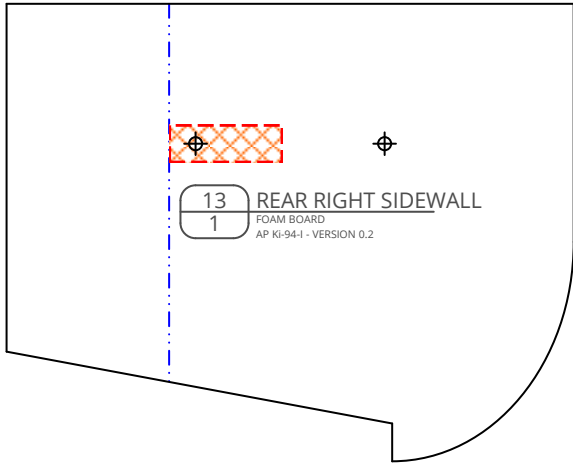
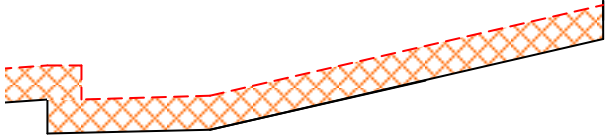
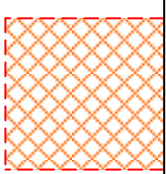

13 REAR RIGHT SIDEWALL
1 FOAM BOARD
AP Ki-94-1 - VERSION 0.2



AP Tachikawa Ki

Design & Drawing by: Tony Roehling

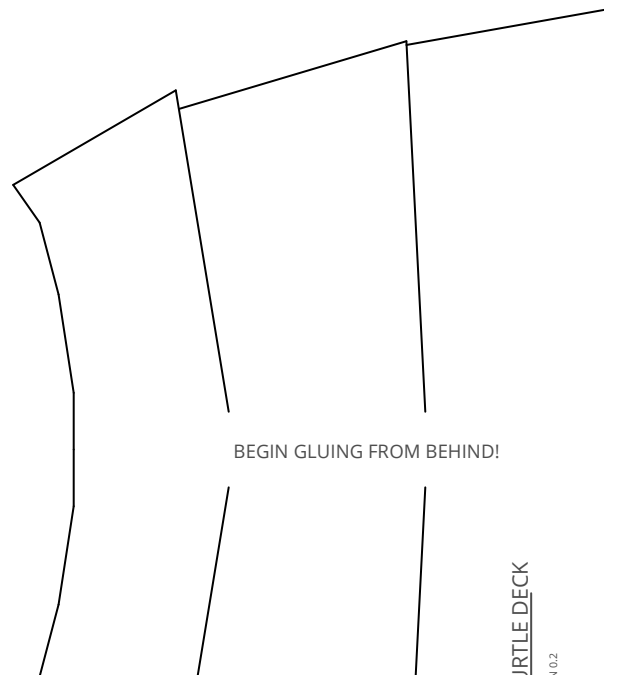

JRTLE DECK
N.O.2

i-94-1 ... THE FLYING SUMO FIGHTER - VEI

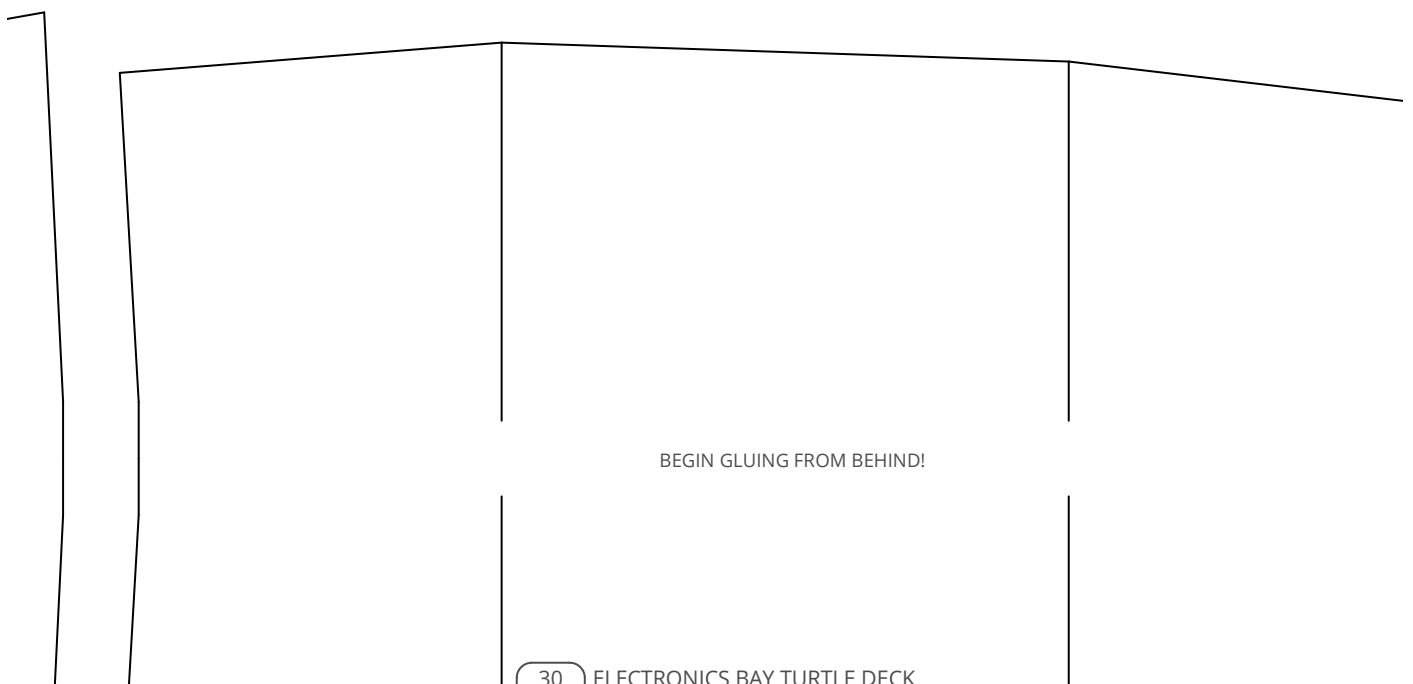

VERSION 0.2 (2018-01-30)

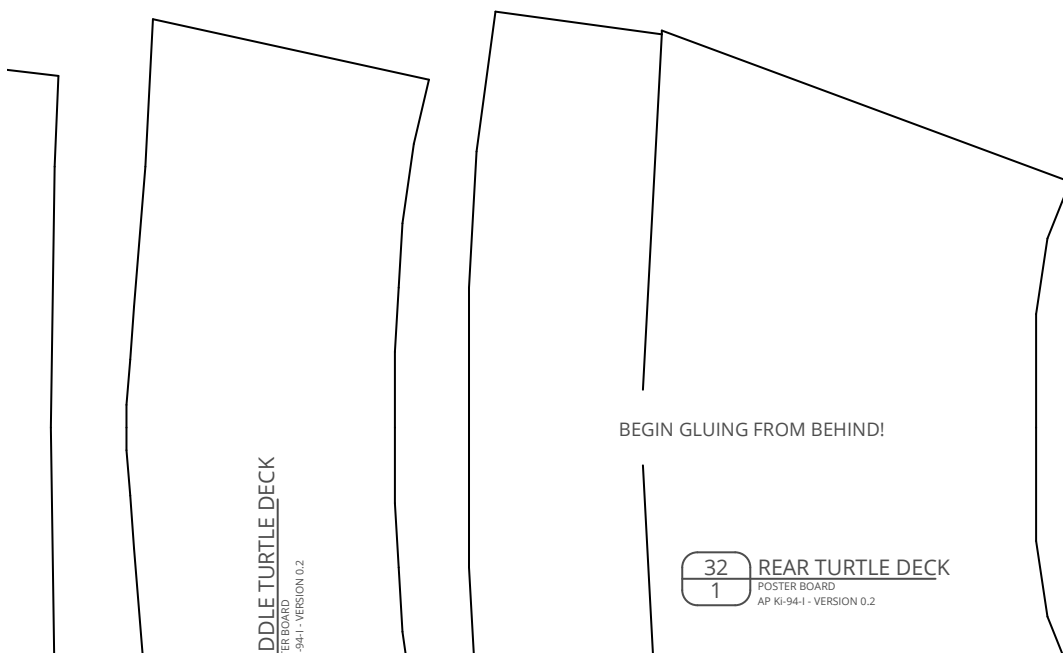

BV

ETA

in
cm

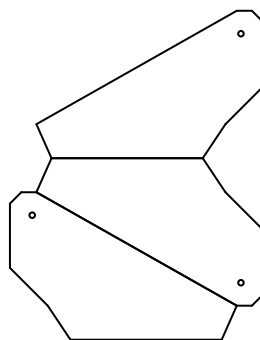

36 CONTROL HORN
3 PLASTIC CARD
AP KI-94-1 - VERSION 0.2

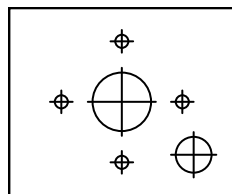

35 MINI FIREWALL
2 PLYWOOD
AP KI-94-1 - VERSION 0.2



SHORTEN THESE PINS TO THE WIDTH



38 POWER POD MOUNT PIN
4 BBQ SKEWER
AP KI-94-1 - VERSION 0.2



39 LOWER GUN
2 BBQ SKEWER
AP KI-94-1 - VERSION 0.2

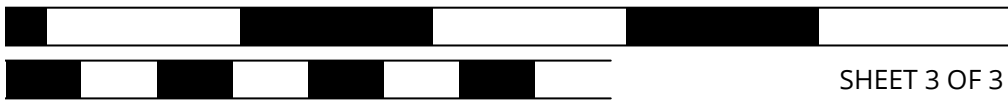

H OF THE FUSELAGE



√

TEMPLATES FOR CUTTING

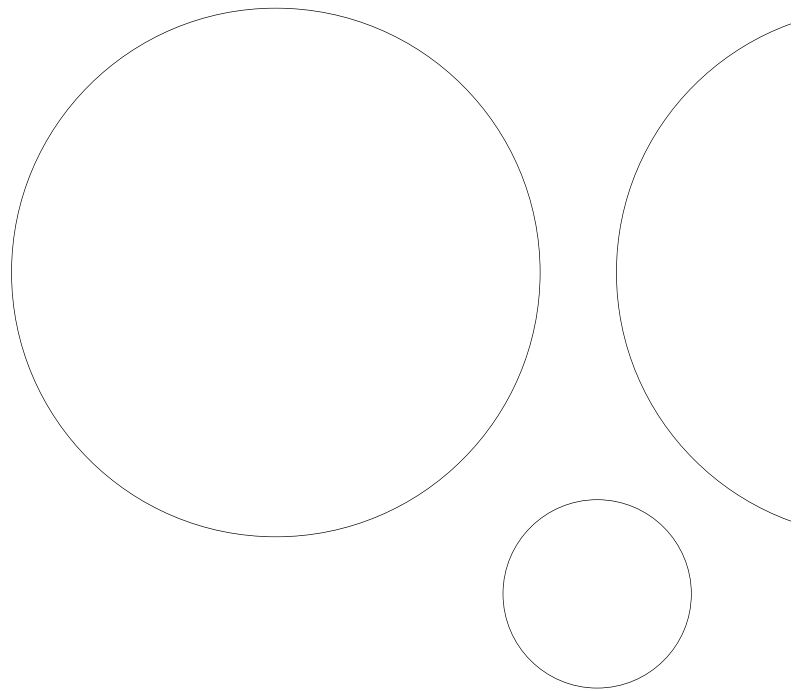

STICKERS

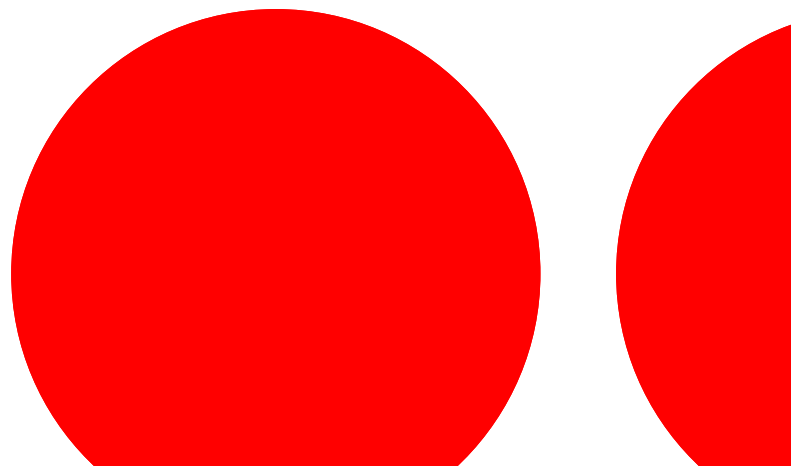

3 ADESIVE FILM

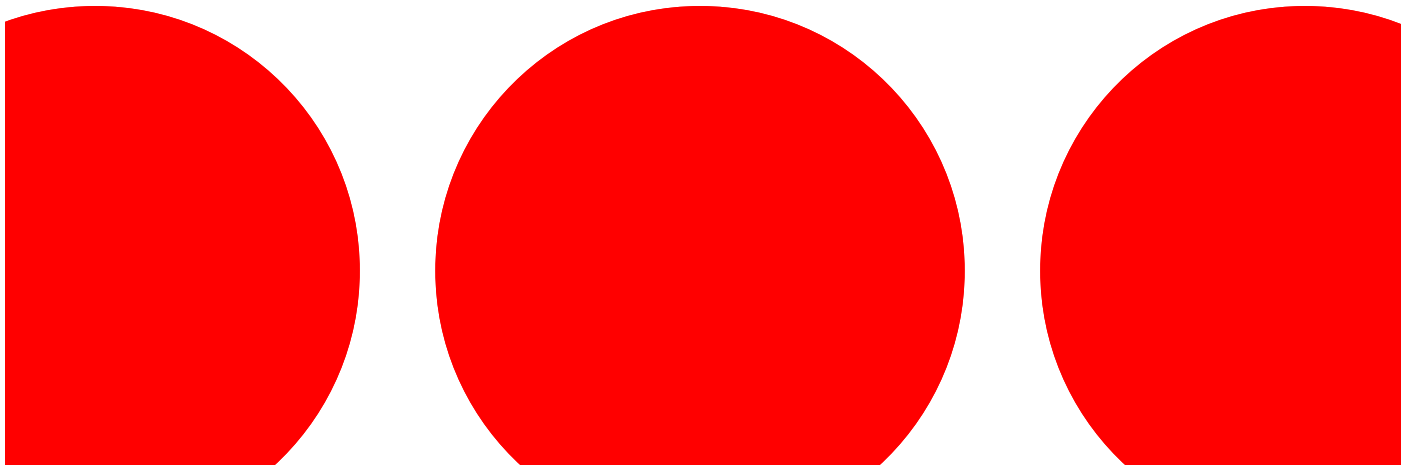
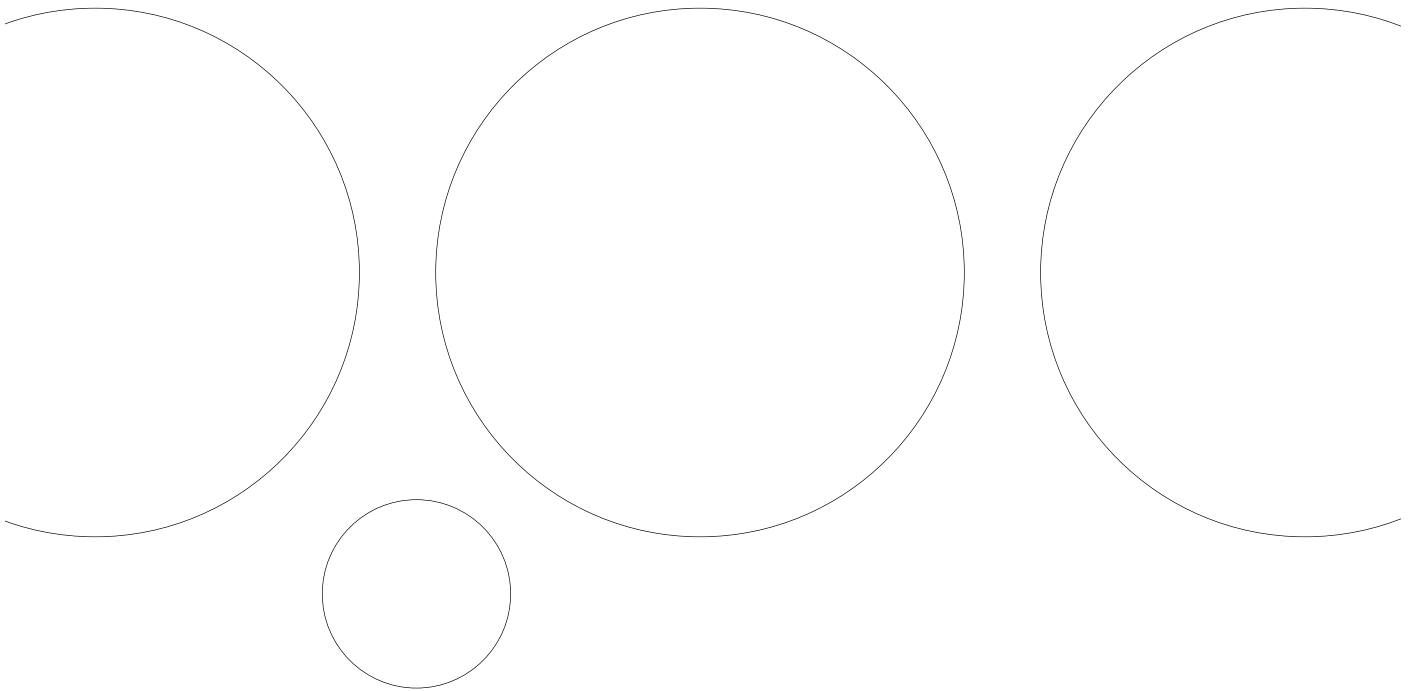

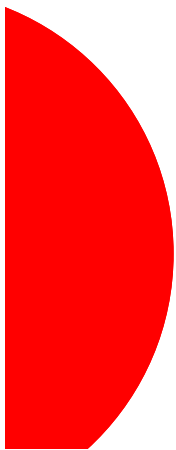
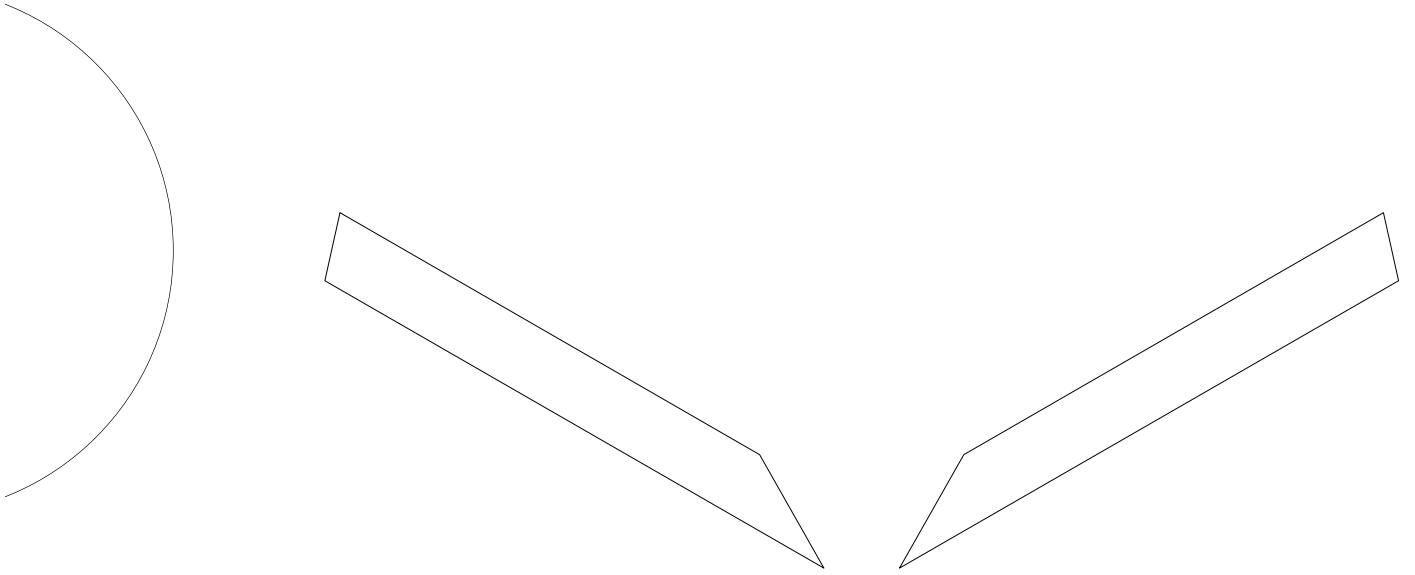
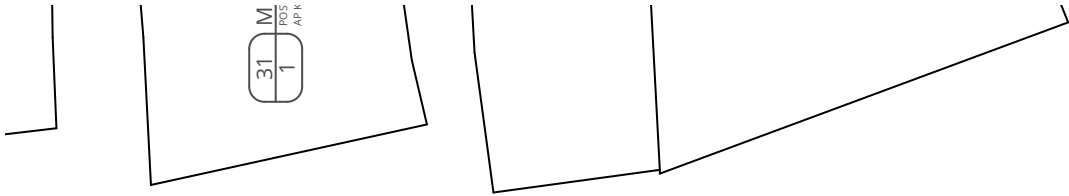

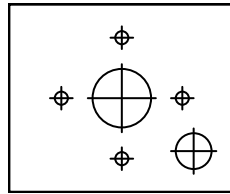

35 MINI FIREWALL
PLYWOOD
AP KI-94-1 - VERSION 0.2



40 UPPER GUN
BBQ SKEWER
AP KI-94-1 - VERSION 0.2



41 ANTENNA
BBQ SKEWER
AP KI-94-1 - VERSION 0.2

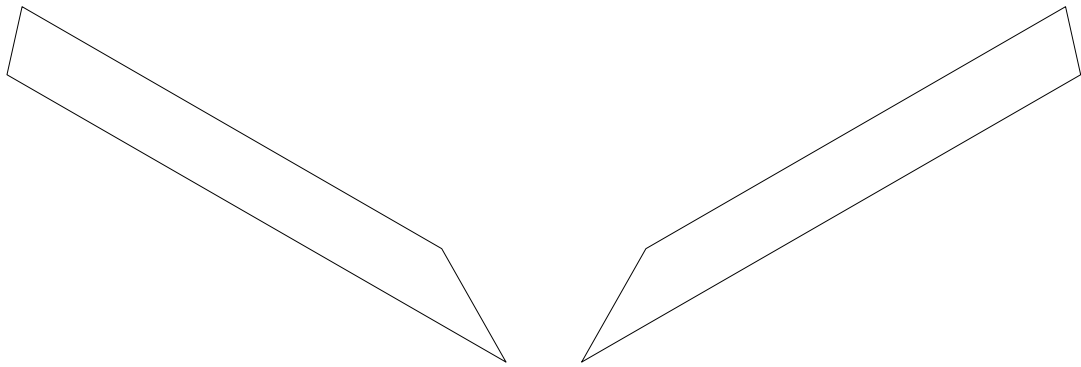



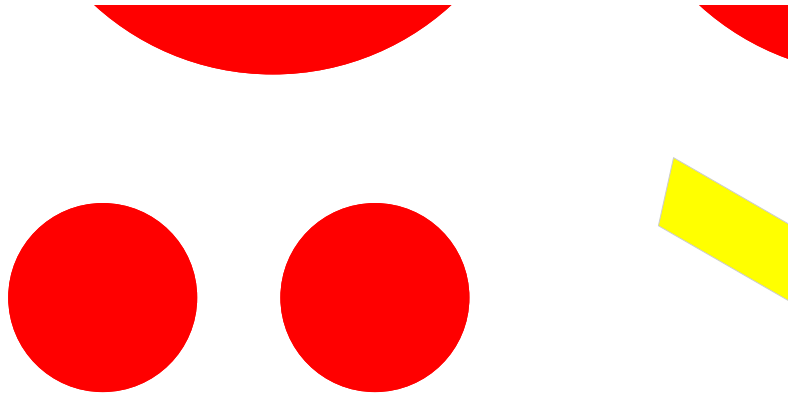

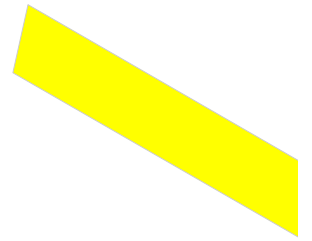
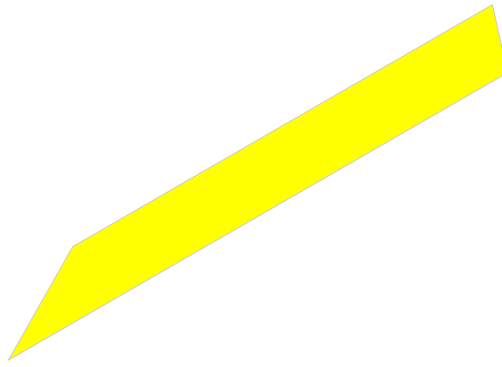
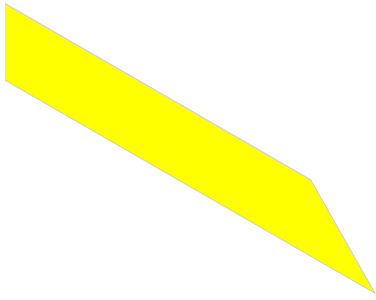

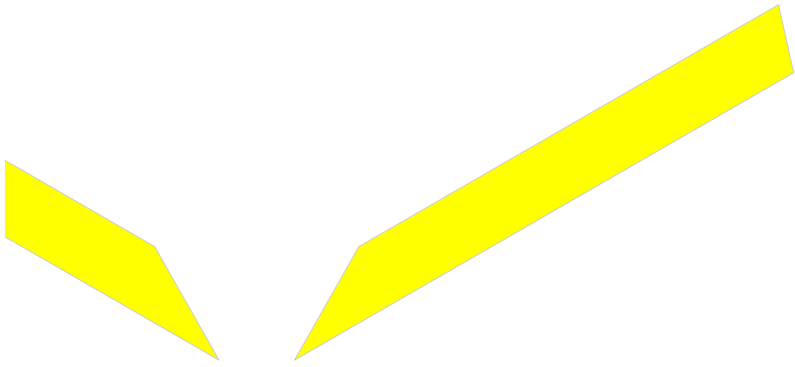

Right © 2017 Airc Pirates. Plans provided free of charge. Copies allowed for personal use only. Not for commercial

use.

