



airc-pirates.com

# AP Tachikawa Ki-94-I

... THE FLYING SUMO FIGHTER

Version 0.2 (2018-01-30)

Design & Drawing by: Tony Roehling

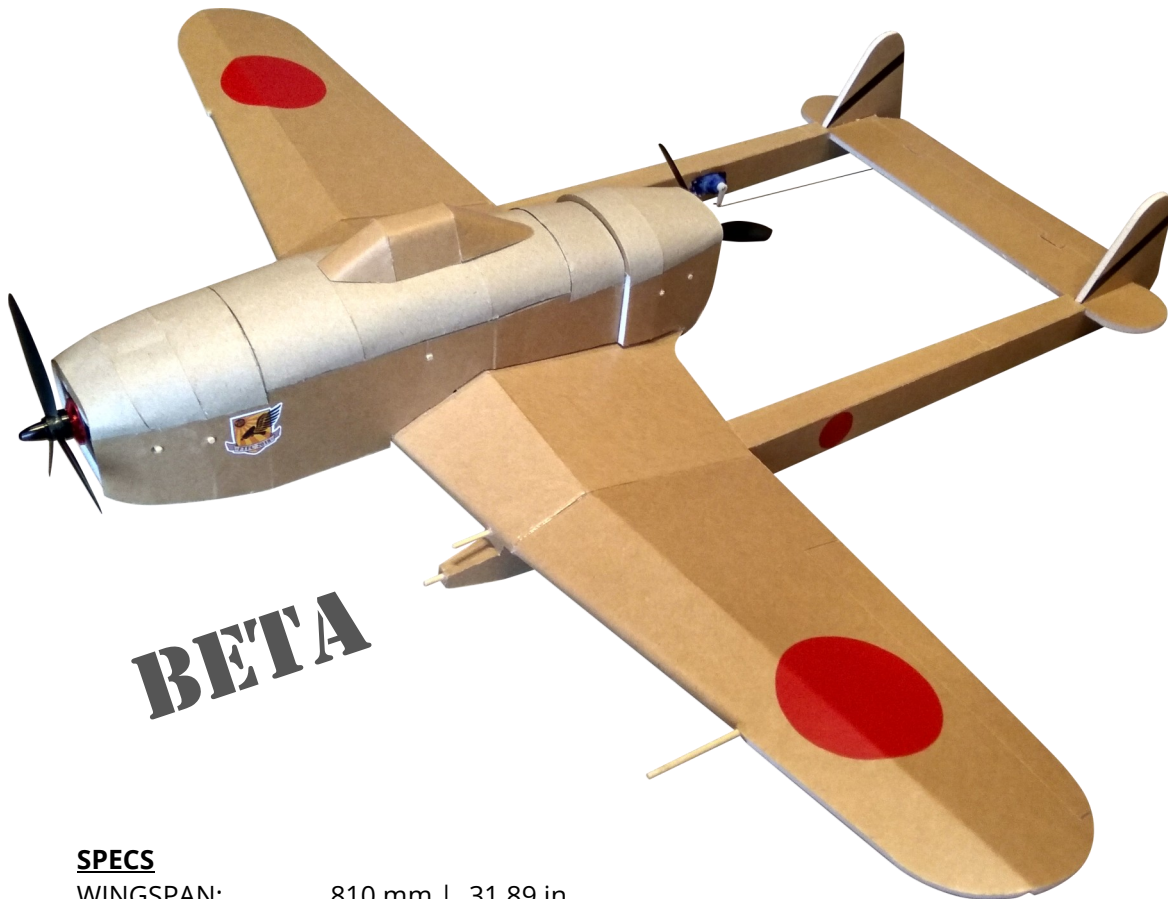

# BETA

## SPECS

WINGSPAN:	810 mm   31.89 in
CG:	60 mm   2.36 in
LENGTH:	680 mm   26.77 in
DRY WEIGHT:	300 g   10.58 oz
ALL UP WEIGHT:	375 g   13.23 oz (with 3s 1000 mAh)
EXPO:	30 %
CHANNELS:	3 (THR   AIL   ELV)

## ELECTRONICS

MOTOR:	2300 kv (1806 or 2204)
PROPELLER:	2 x 5x5 or 6x4 (CW & CCW)
ESC:	2 x 12 A
SERVOS:	3 x 5 g
BATTERY:	1000 mAh 3s



# DRAWING KEY

... is based on the Flite Test Drawing Key by Dan Sponholz

## FOLD TYPES

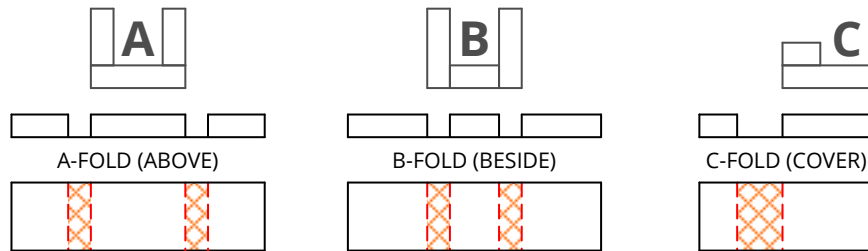

## LINE TYPE/COLOR

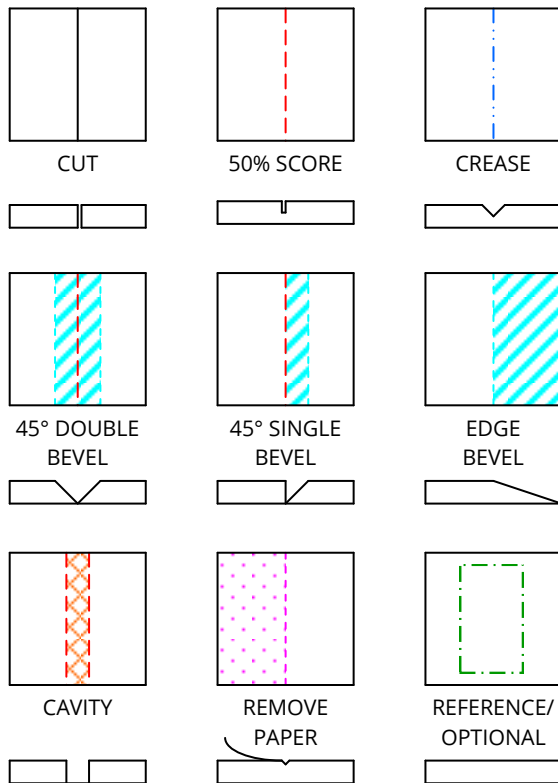

## SYMBOLS

PART NUMBER

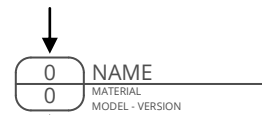

QUANTITY



DOWEL HOLE



CENTER OF GRAVITY (CG)

# BETA

## AP Tachikawa Ki-94-I PARTS LIST 1/2

Version 0.2 (2018-01-30)

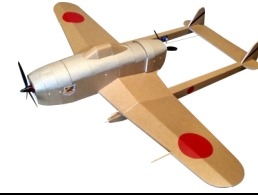

PART NR.	DESCRIPTION	QUANTITY	MATERIAL	SHEET
1	MIDDLE WING	1	FOAM BOARD	1
2	MIDDLE WING SPAR	1	FOAM BOARD	1
3	OUTER WING SPAR	2	FOAM BOARD	1
4	RIGHT WING	1	FOAM BOARD	1
5	LEFT WING	1	FOAM BOARD	1
6	HORIZONTAL STABILIZER	1	FOAM BOARD	1
7	VERTICAL STABILIZER	2	FOAM BOARD	1
8	RIGHT TAIL BOOM	1	FOAM BOARD	2
9	LEFT TAIL BOOM	1	FOAM BOARD	2
10	RIGHT TAIL BOOM SHEETING	1	FOAM BOARD	2
11	LEFT TAIL BOOM SHEETING	1	FOAM BOARD	2
12	FUSELAGE	1	FOAM BOARD	2
13	REAR RIGHT SIDEWALL	1	FOAM BOARD	2
14	REAR LEFT SIDEWALL	1	FOAM BOARD	2
15	FRONT POWER POD SPACER	2	FOAM BOARD	2
16	REAR POWER POD SPACER	2	FOAM BOARD	2
17	LOWER FRONT SHEETING	1	FOAM BOARD	2
18	LOWER REAR SHEETING	1	FOAM BOARD	2
19	FORMER A	1	FOAM BOARD	2
20	FORMER B	1	FOAM BOARD	2
21	FORMER C	1	FOAM BOARD	2
22	FORMER D	1	FOAM BOARD	2
23	FORMER E	1	FOAM BOARD	2
24	FORMER F	1	FOAM BOARD	2
25	ELECTRONICS BAY SHEETING	1	FOAM BOARD	2
26	FORMER G	1	FOAM BOARD	2
27	FORMER H	1	FOAM BOARD	2
28	ELECTRONICS BAY PIN	2	FOAM BOARD	2
29	FRONT TURTLE DECK	1	POSTER BOARD	3
30	ELECTRONICS BAY TURTLE DECK	1	POSTER BOARD	3
31	MIDDLE TURTLE DECK	1	POSTER BOARD	3
32	REAR TURTLE DECK	1	POSTER BOARD	3
33	CANOPY	1	FOAM BOARD	2
34	MINI POWER POD	2	FOAM BOARD	2
35	MINI FIREWALL	2	PLYWOOD max. 5mm	3

**Build the Ki-94-I in the order of the part numbers!**

# BETA

## AP Tachikawa Ki-94-I PARTS LIST 2/2

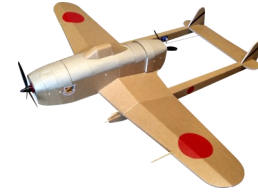

Version 0.2 (2018-01-30)

PART NR.	DESCRIPTION	QUANTITY	MATERIAL	SHEET
36	CONTROL HORN	3	PLASTIC CARD	3
37	CANOPY MOUNT PIN	1	BBQ SKEWER	3
38	POWER POD MOUNT PIN	4	BBQ SKEWER	3
39	LOWER GUNS	2	BBQ SKEWER	3
40	UPPER GUNS	2	BBQ SKEWER	3
41	ANTENNA	1	BBQ SKEWER	3
G1	DIHEDRAL GAUGE	1	FOAM BOARD	1
G2	90° TRIANGLE	1	FOAM BOARD	2
G3	THROW GAUGE	1	FOAM BOARD	2
	<b>OTHER MATERIALS</b>			
	STEEL WIRE (Ø 1mm) FOR THE LINKAGE RODS			
	VELCRO TO MOUNT THE BATTERY, ESC, ...			

### Hints:

You need counter-rotating propellers (CW & CCW) and a Y-Power-Cable to connect the two ESCs with the battery.

Please do not forget to remove the red cable from the signal cable at one ESC, bend it back and fix it with some tape. You have to do this for every Twin model using two ESCs!

**Build the Ki-94-I in the order of the part numbers!**

# AP Tachikawa I

Design & Drawing by: Tony Roehling

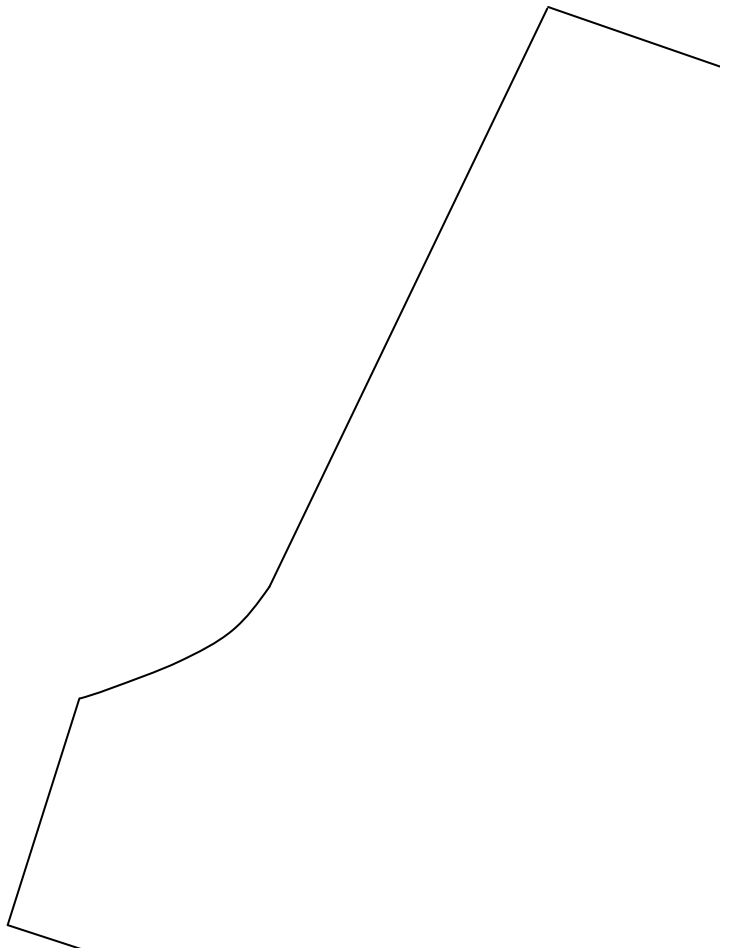

---

# Ki-94-I ... THE FLYING SUMO FIGHTER - VE

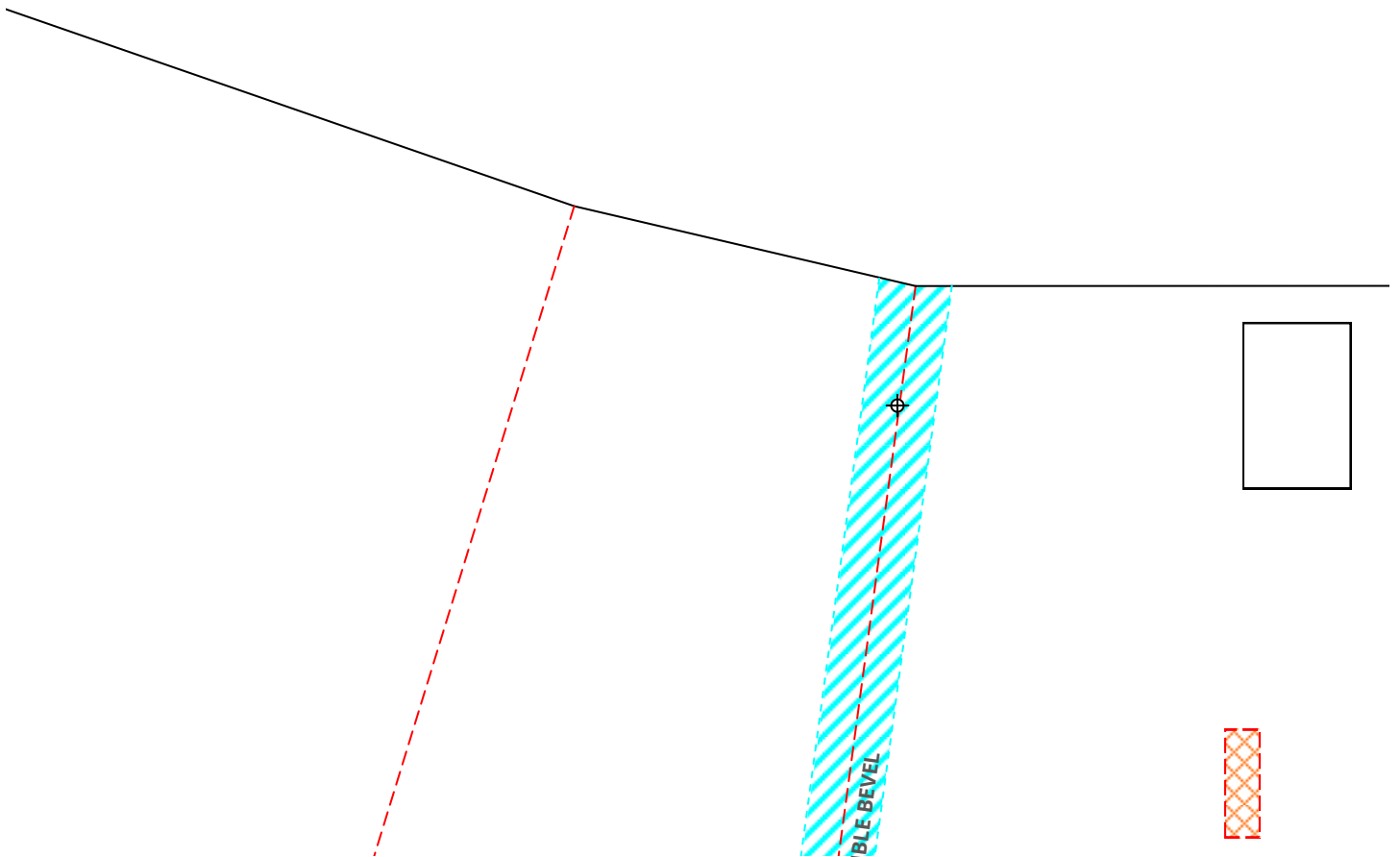

---

# VERSION 0.2 (2018-01-30)

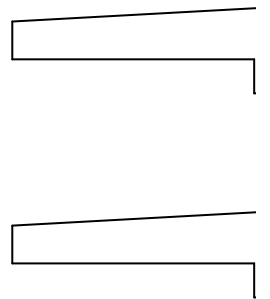
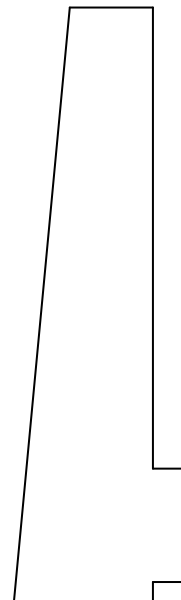
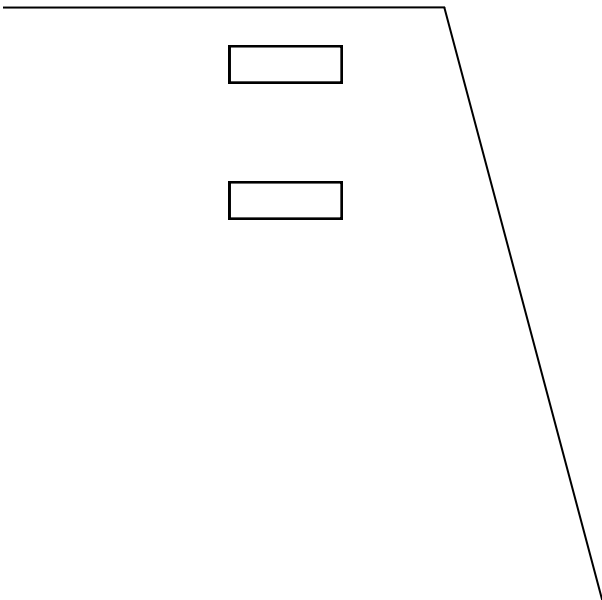
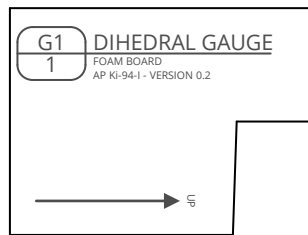

in   
cm 

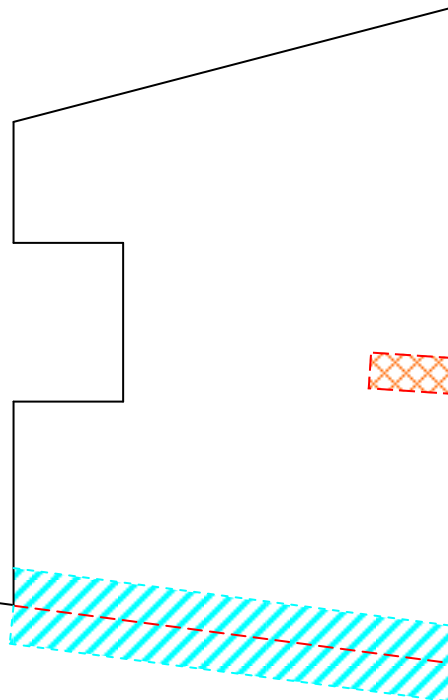
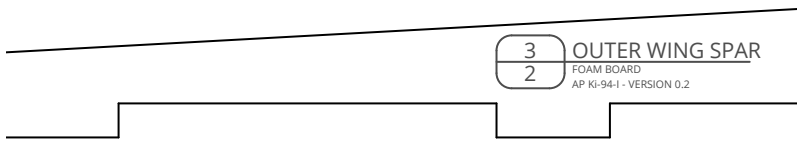
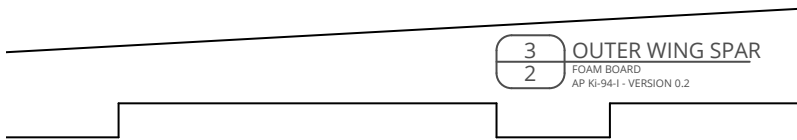



5 LEFT WING  
1 FOAM BOARD  
AP KI-94-1 - VERSION 0.2

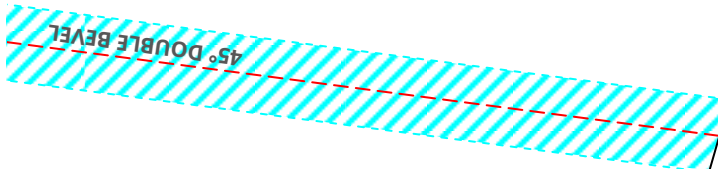

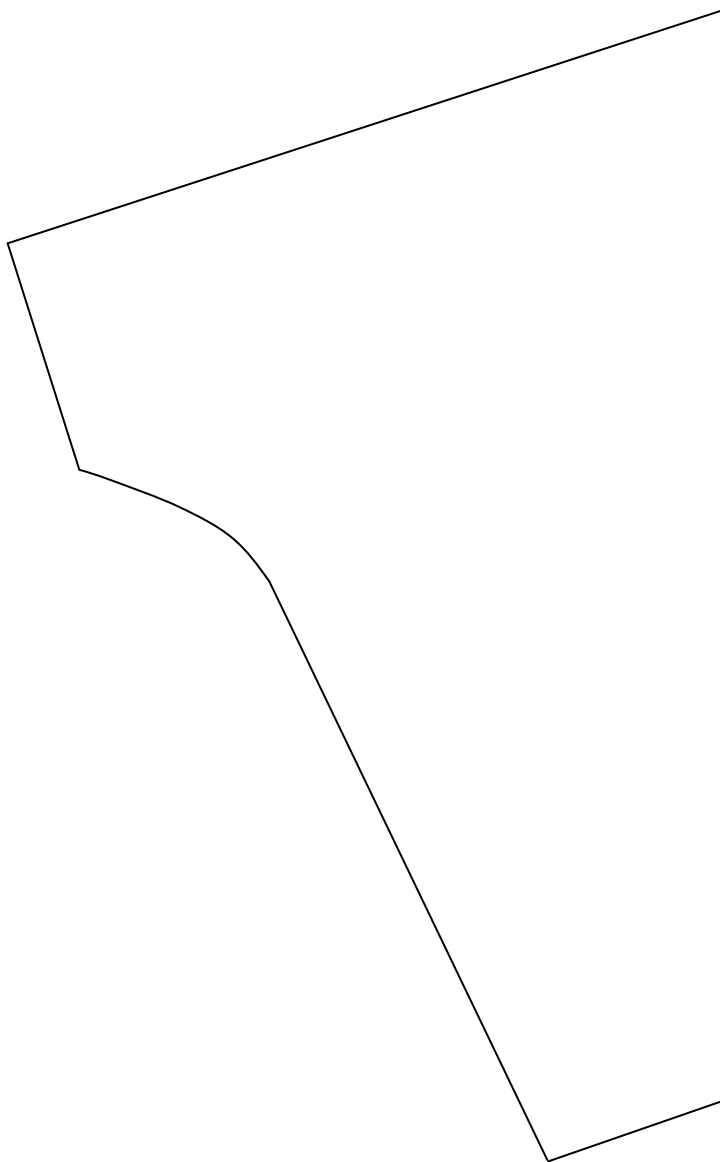
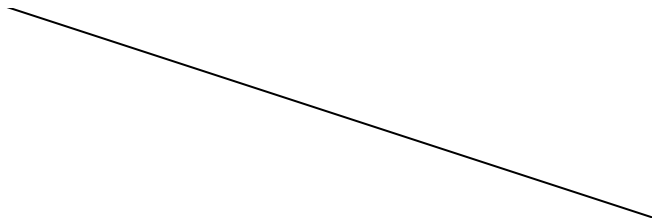

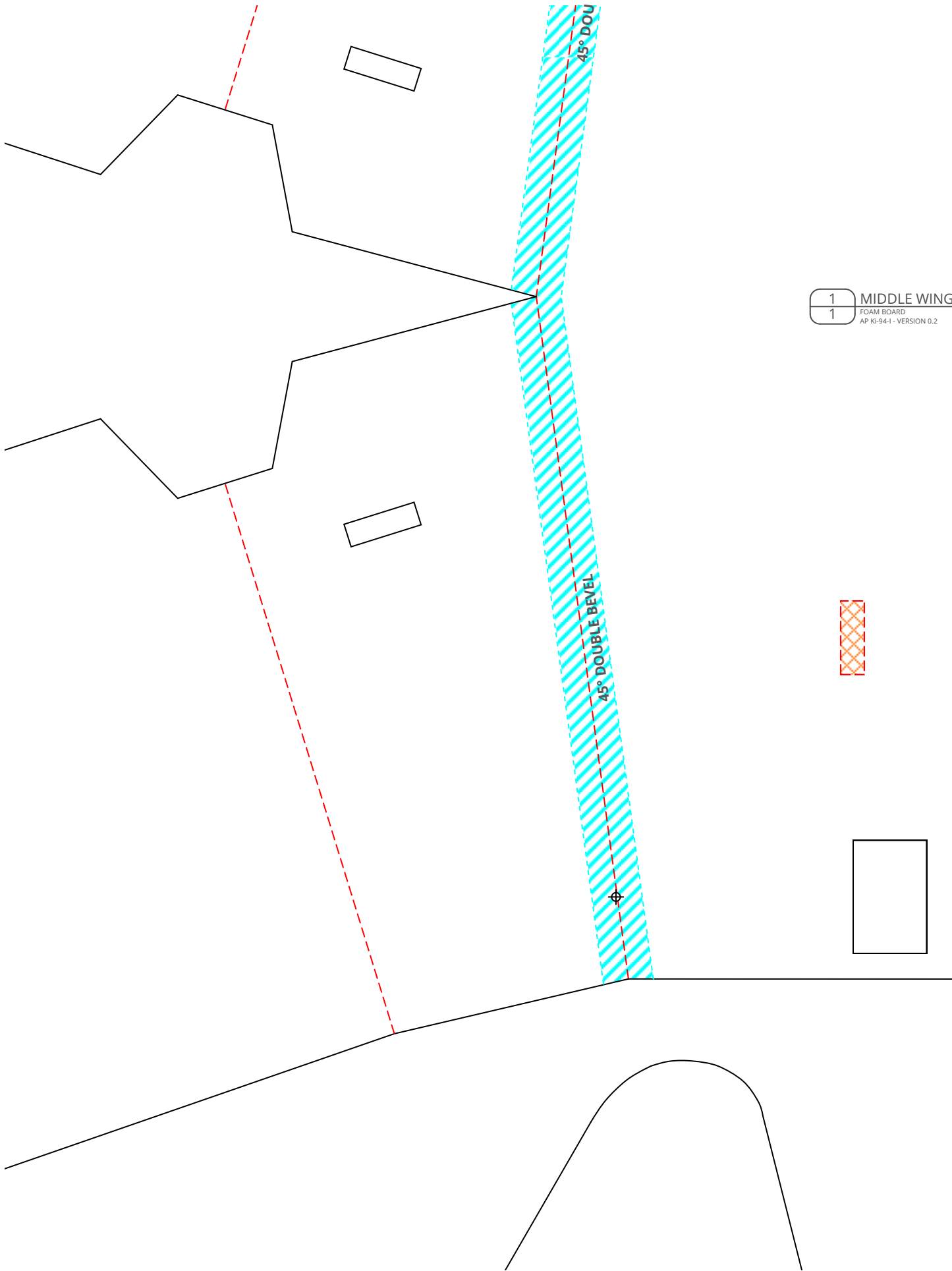

1 MIDDLE WING  
1 FOAM BOARD  
AP Ki-94-1 - VERSION 0.2

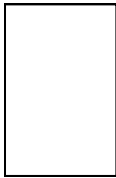

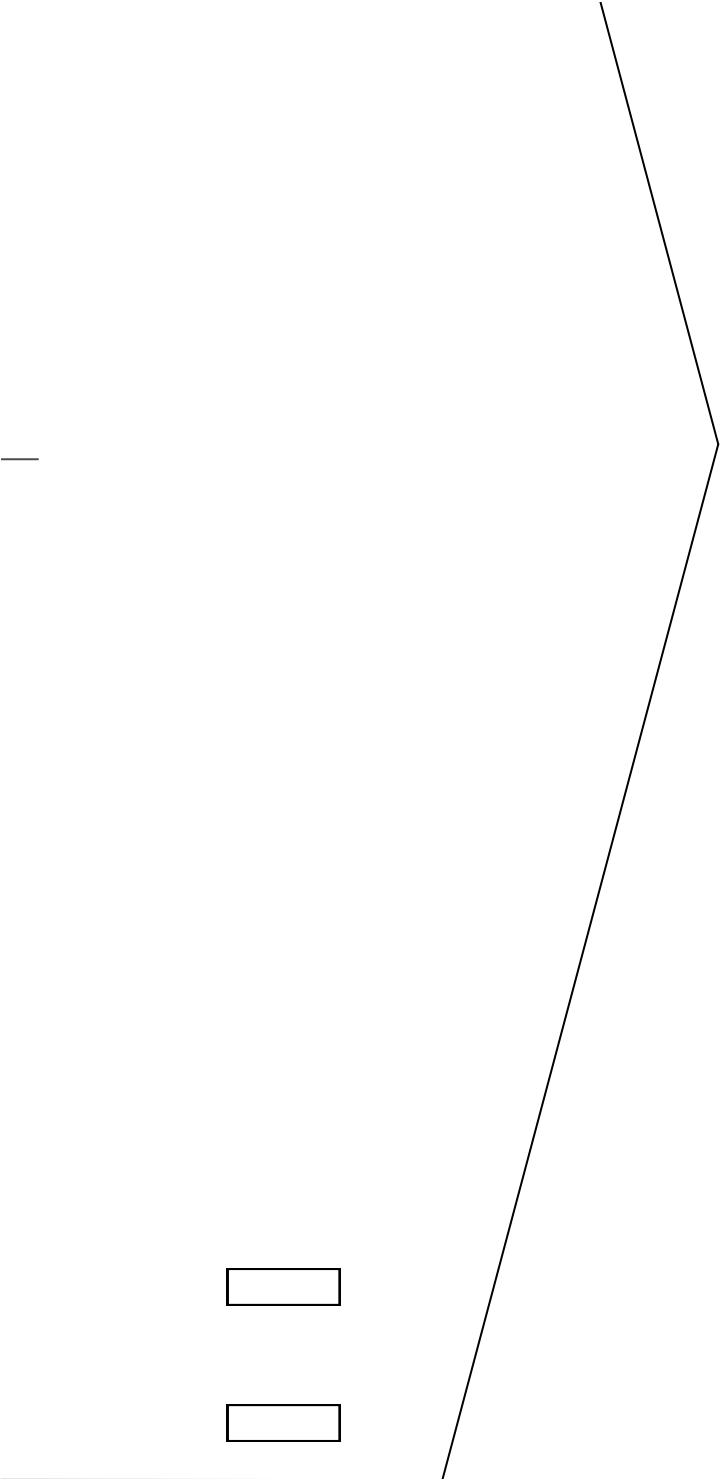

2 MIDDLE WING SPAR  
FOR BOARD  
1 AP-1541 - VERSION 0.2

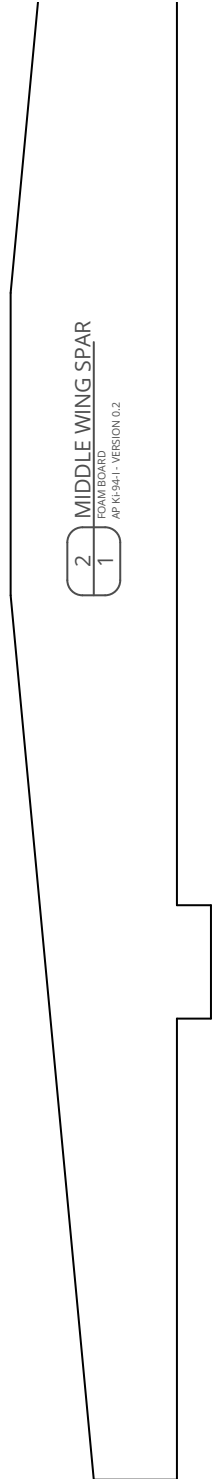

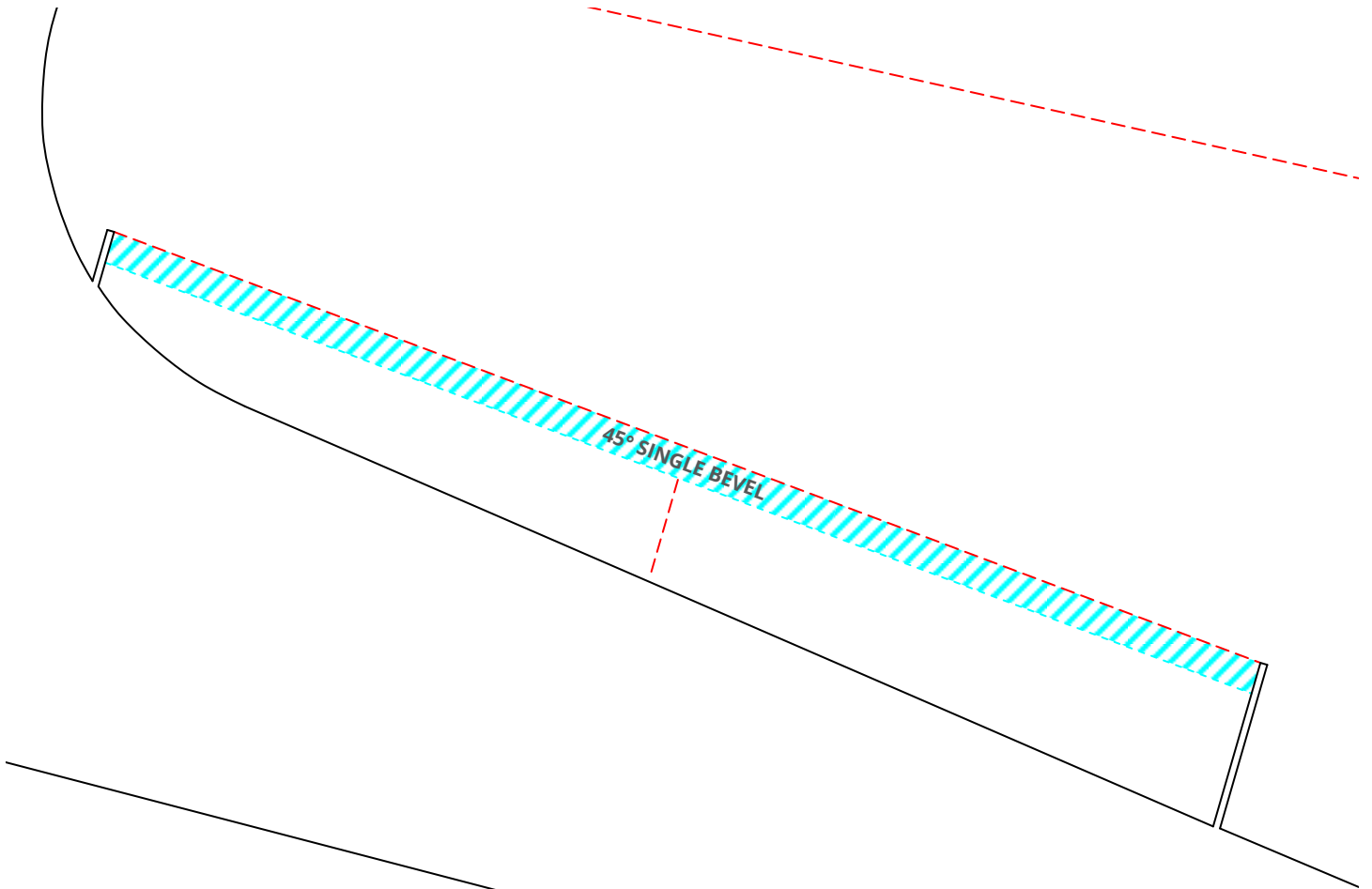

4 RIGHT WING  
1 FOAM BOARD  
AP Ki-94-1 - VERSION 0.2

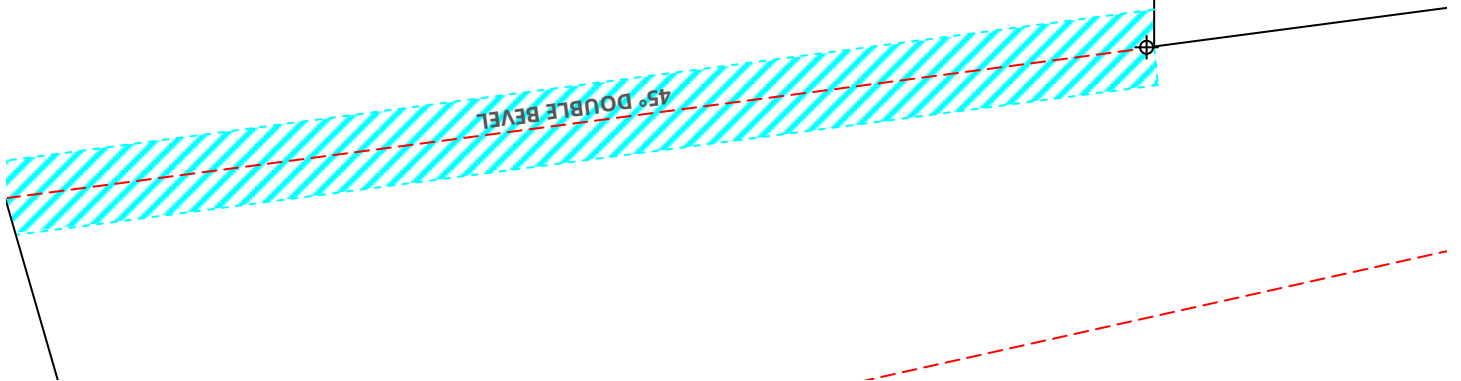

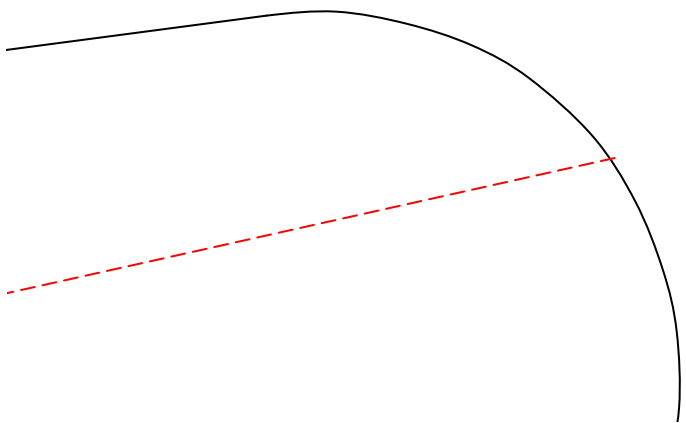
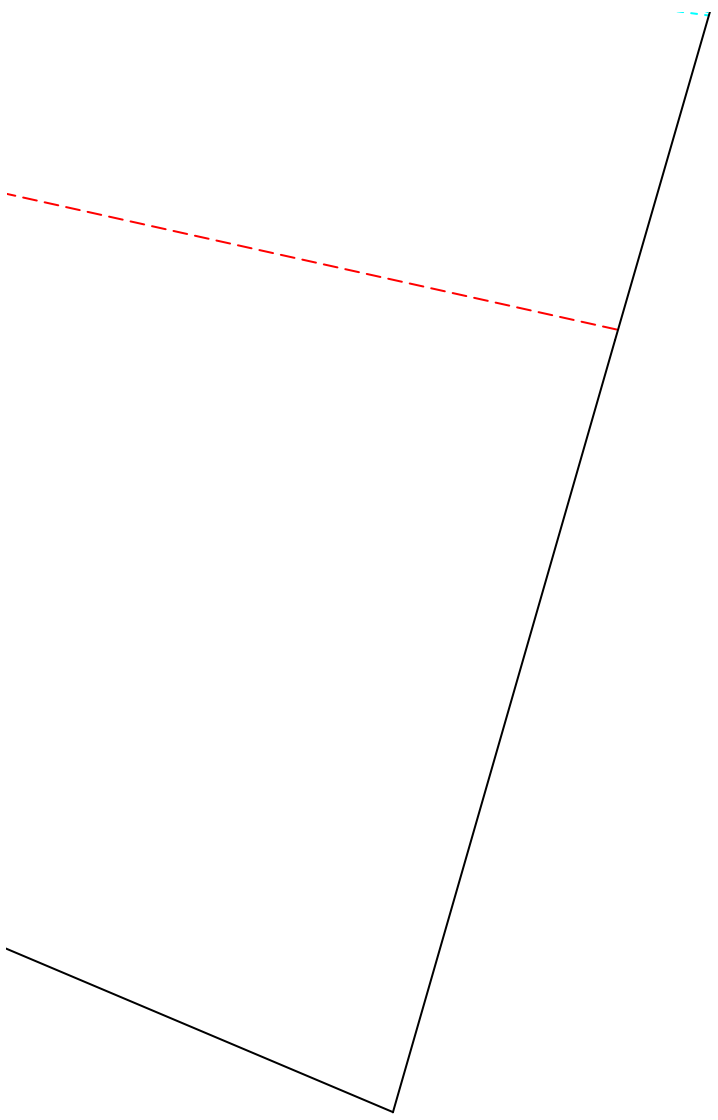

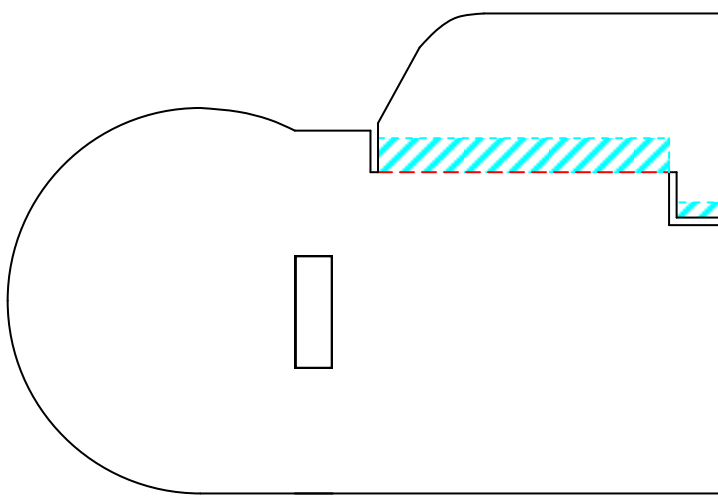

[airc-pirates.com](http://airc-pirates.com)

7 VERTICAL STABILIZER  
FOAM BOARD  
2 AP Ki-94-1 - VERSION 0.2

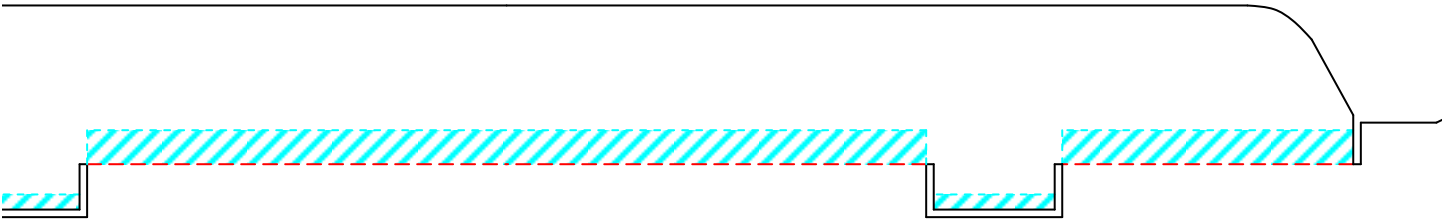
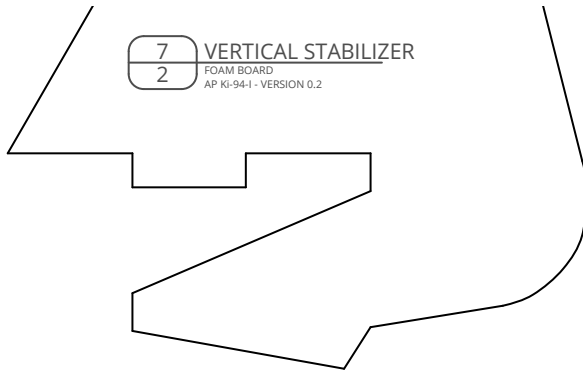

6 HORIZONTAL STABILIZER  
FOAM BOARD  
1 AP Ki-94-1 - VERSION 0.2





7 VERTICAL STABILIZER  
2 FOAM BOARD  
AP KI-94-1 - VERSION 0.2

**BETA**

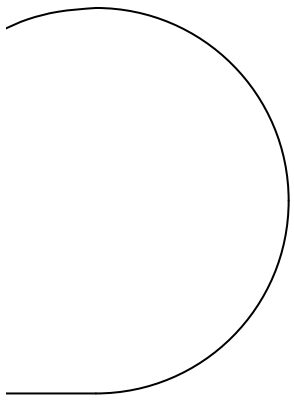

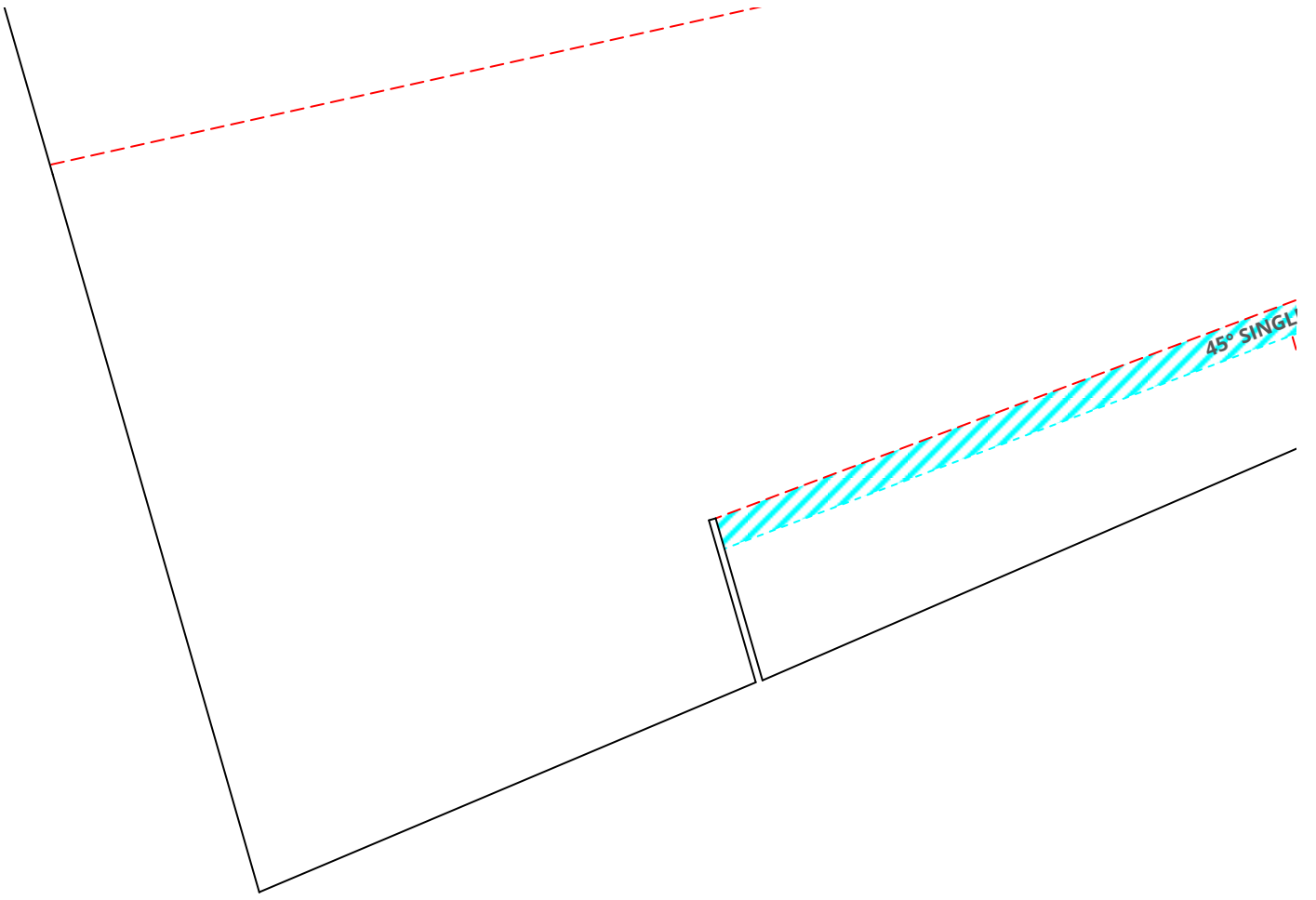

ise.

---

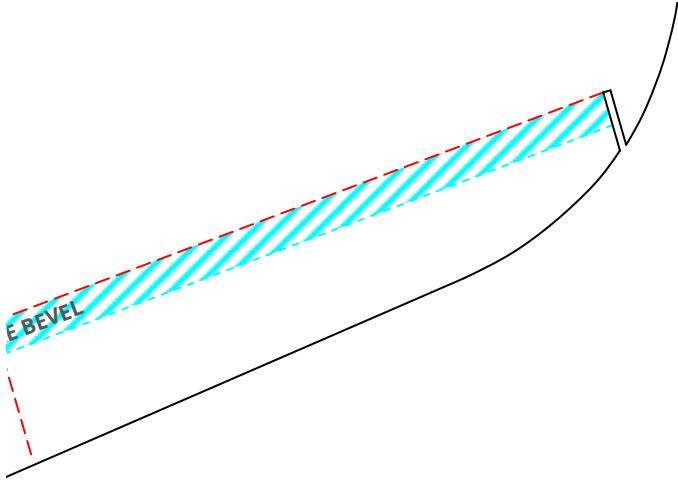

# AP Tachikawa I

Design & Drawing by: Tony Roehling

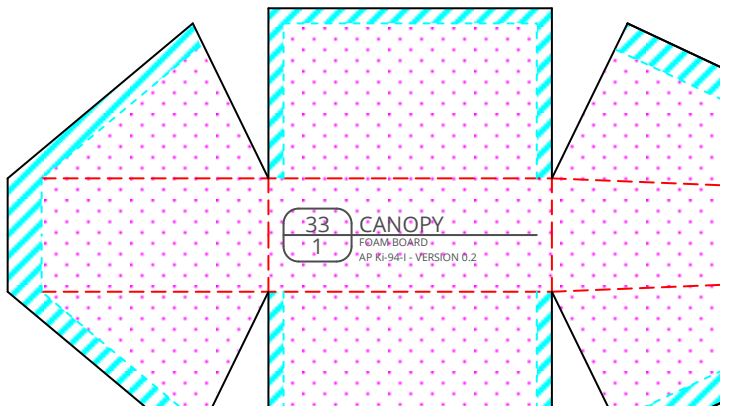
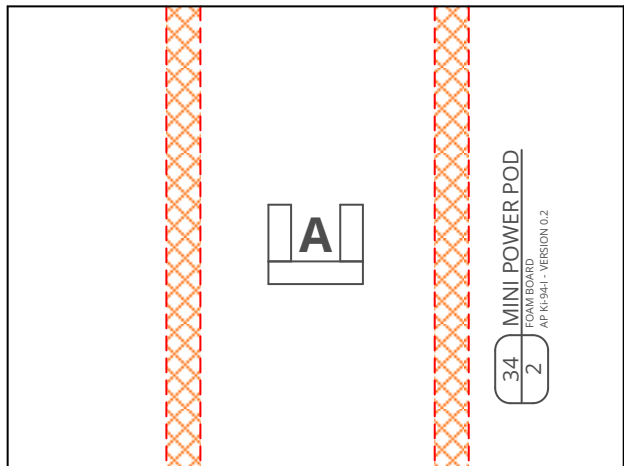

# Ki-94-I ... THE FLYING SUMO FIGHTER - VE

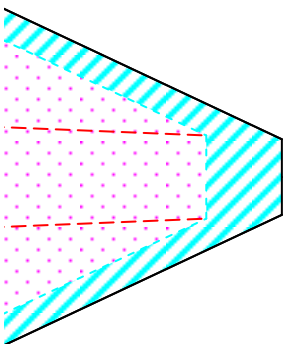
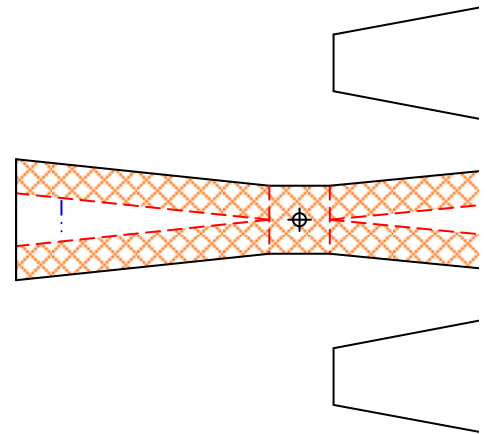
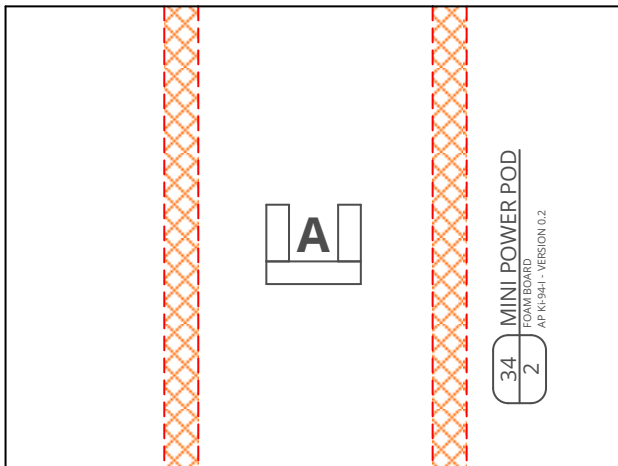

**BETA**

# VERSION 0.2 (2018-01-30)

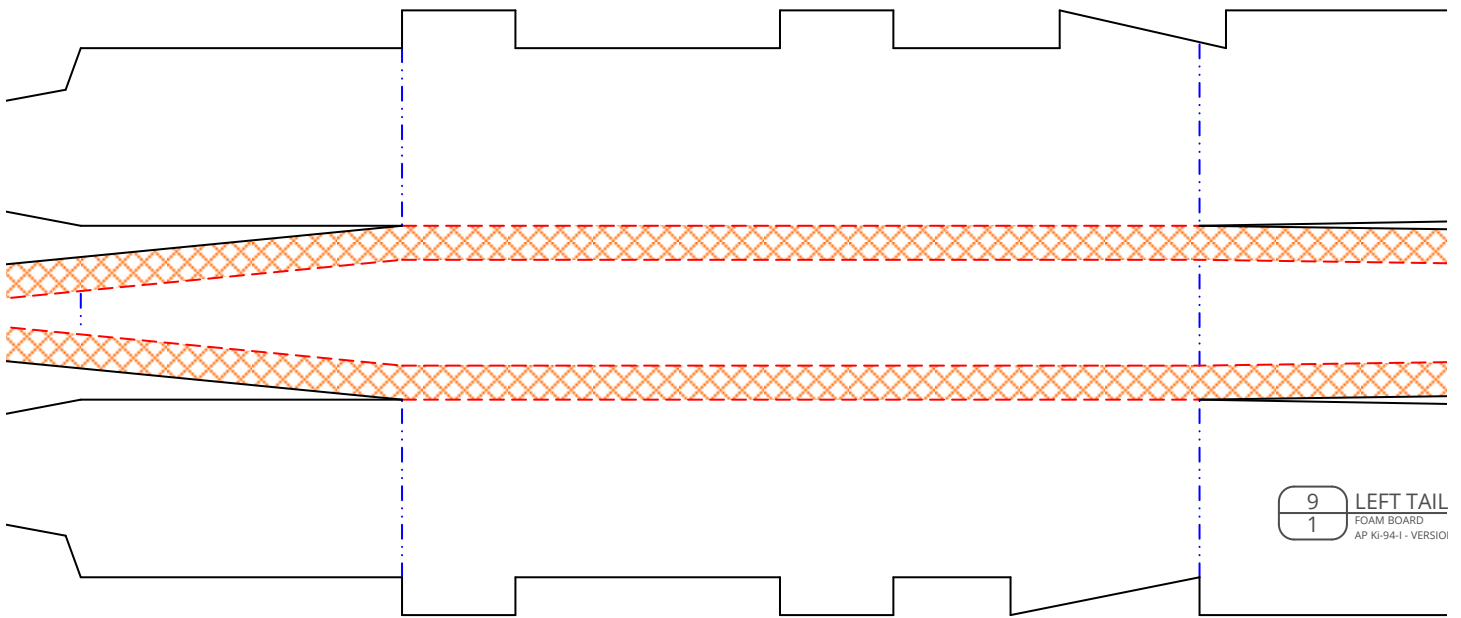

9 LEFT TAIL  
FOAM BOARD  
AP KI-94-I - VERSION 0.2

11 LEFT TAIL BC  
FOAM BOARD  
AP KI-94-I - VERSION 0.2

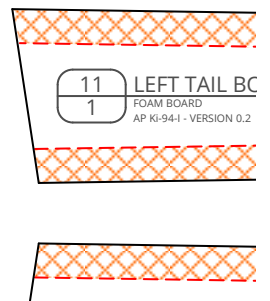

in   
cm

BOOM

N 0.2

BOOM SHEETING

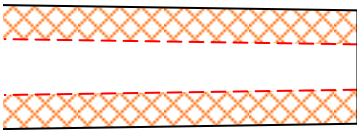
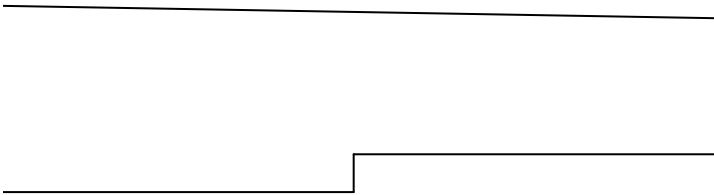
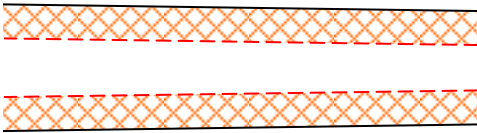
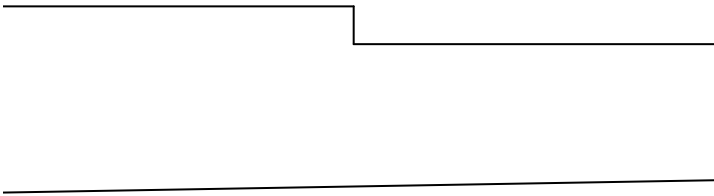



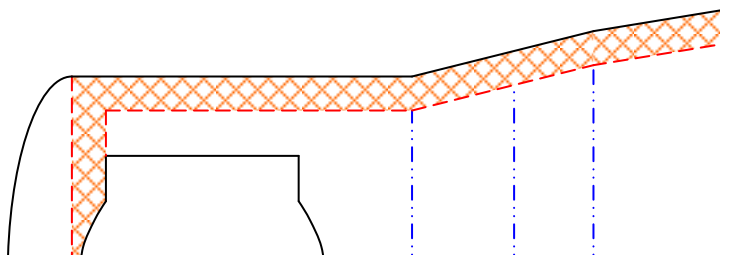
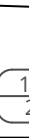
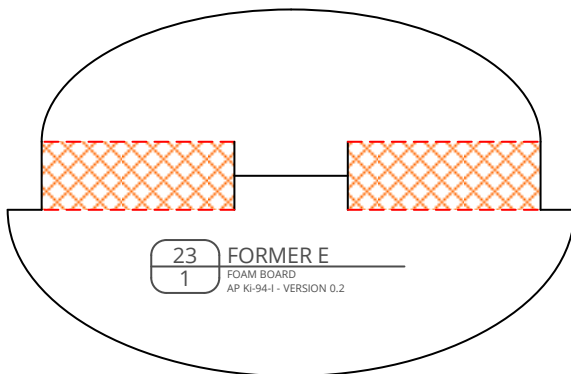
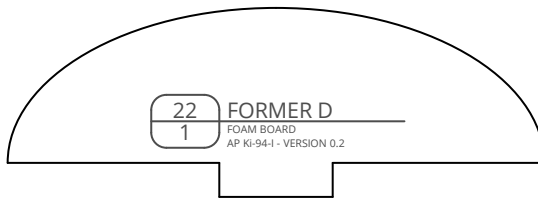
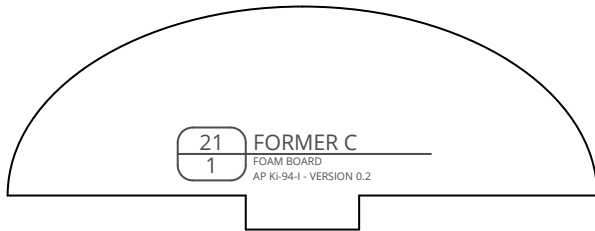
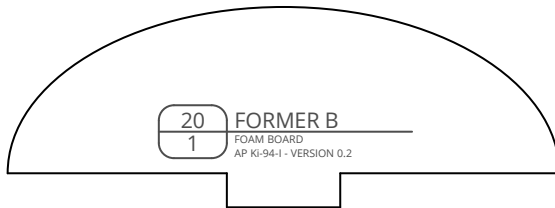
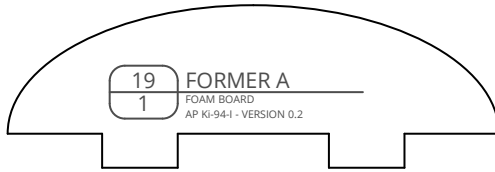
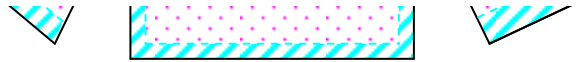

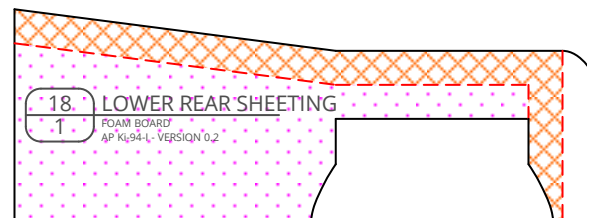
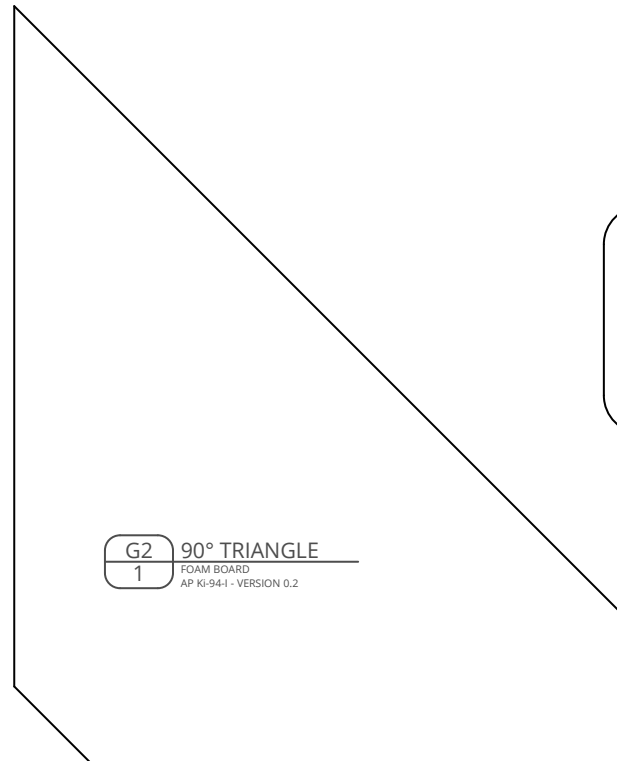
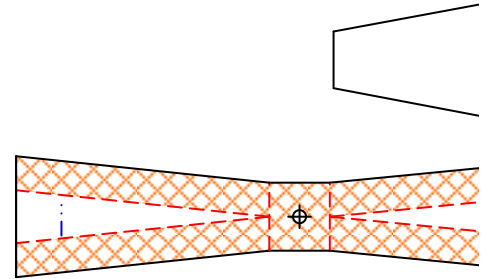
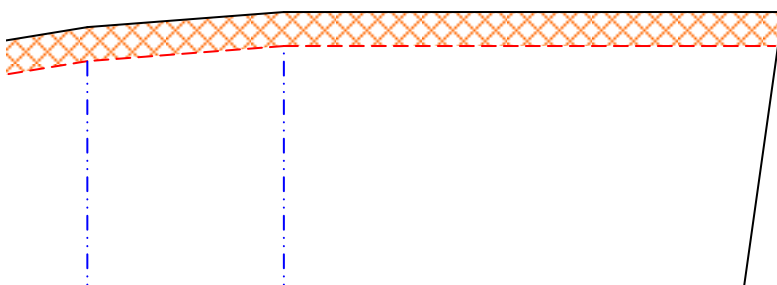
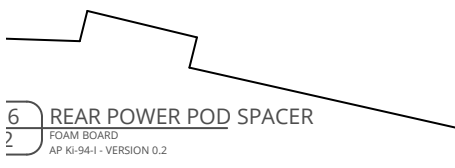
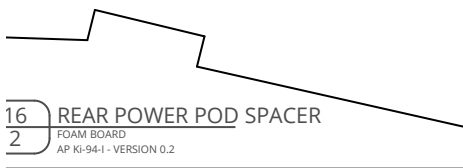
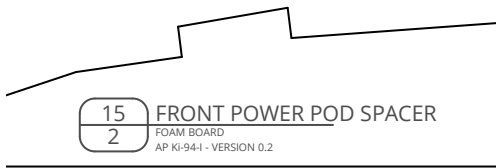
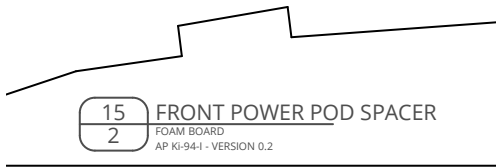
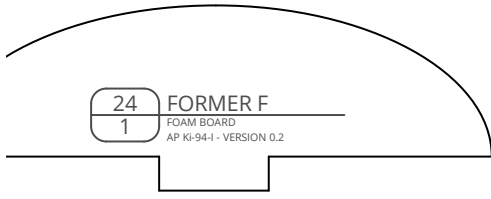

10 RIGHT TAIL  
FOAM BOARD  
1 AP KI-94-1 - VERSION 0

8 RIGHT TA  
FOAM BOARD  
1 AP KI-94-1 - VERSIO

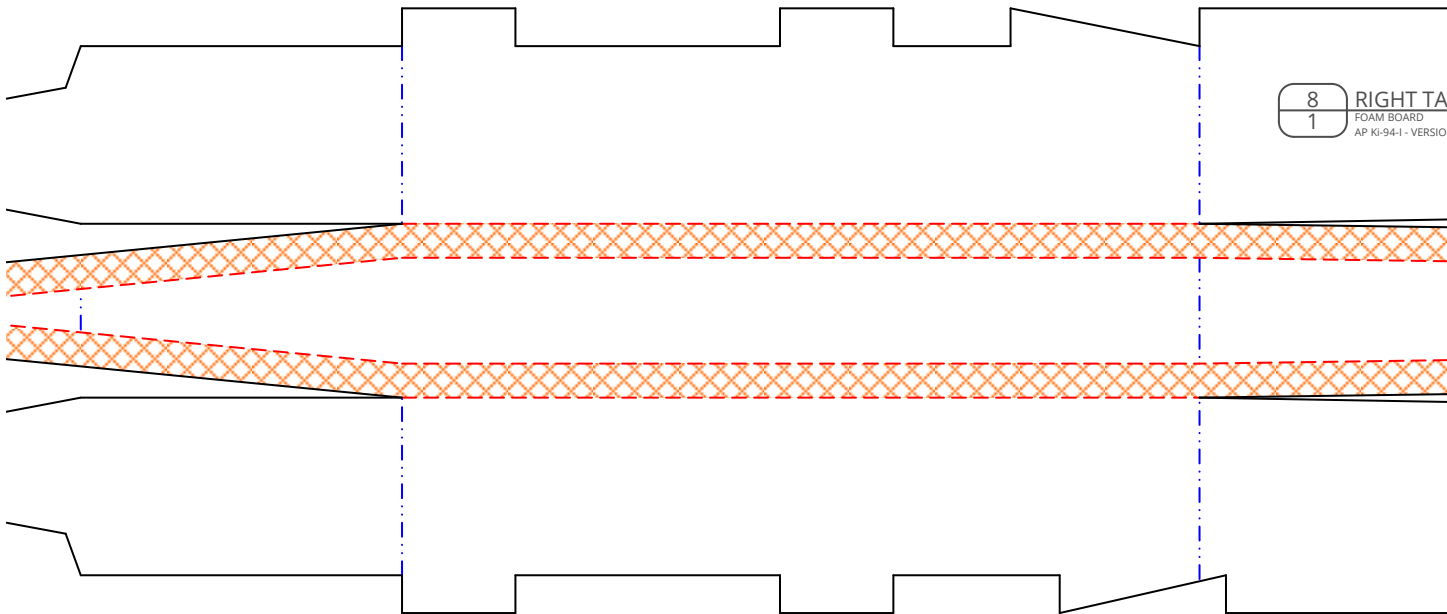

G3 THROW GAUGE  
FOAM BOARD  
1 AP KI-94-1 - VERSION 0.2

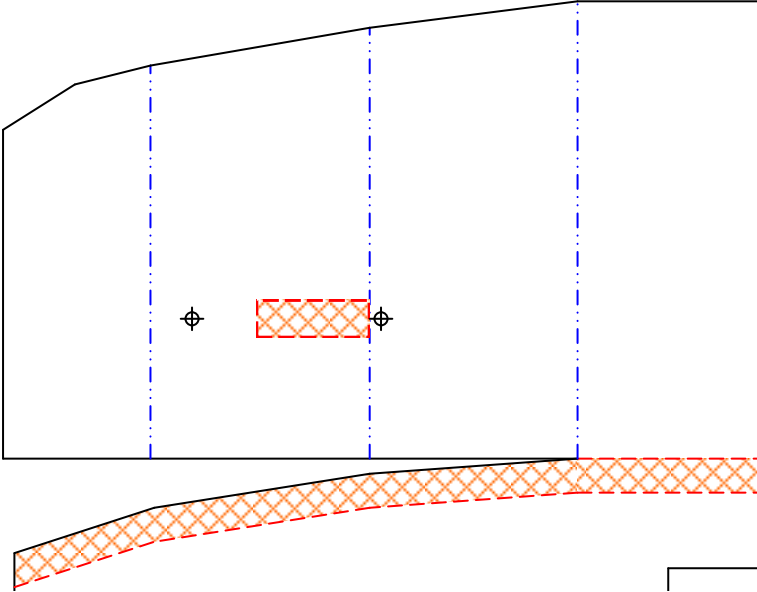
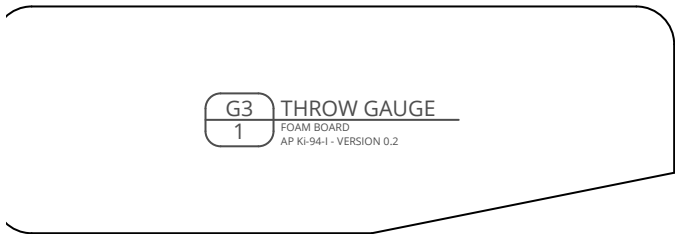

BOOM SHEETING

1:2

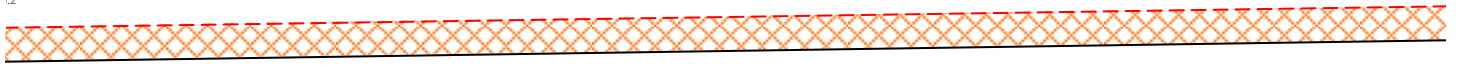

IL BOOM

N 0.2

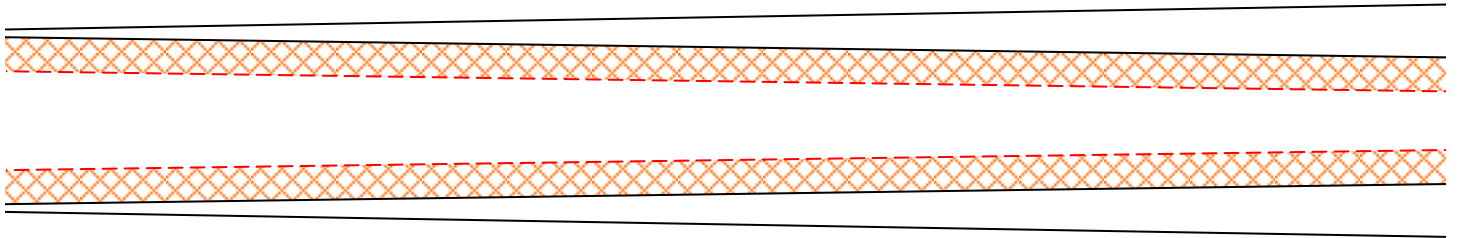

HOLE FOR  
HXT 500 SERVO

28  
2

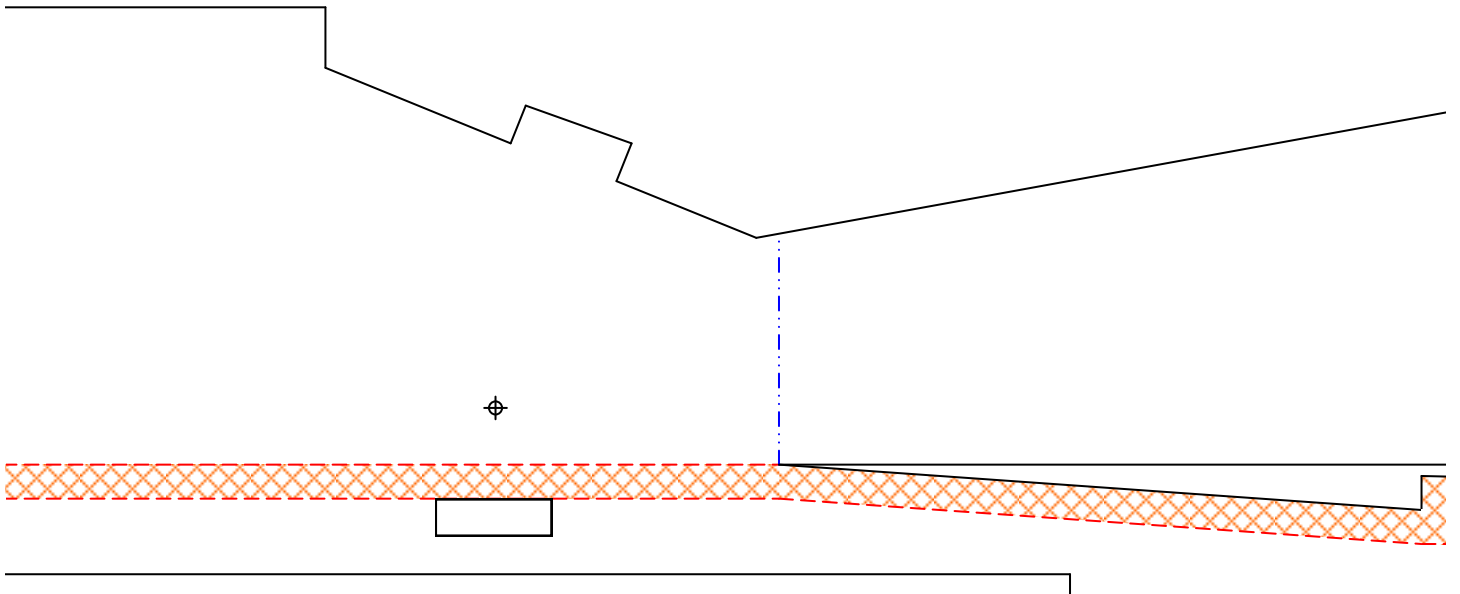

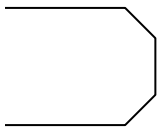
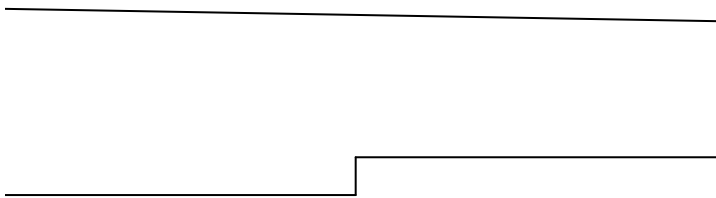
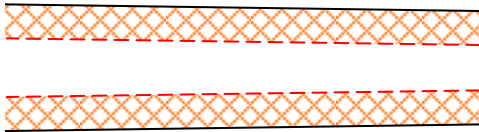
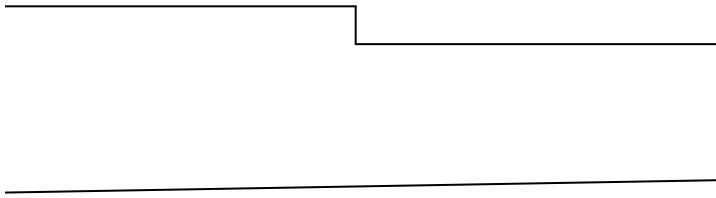
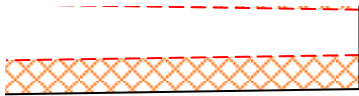

3 ELECTRONICS BAY PIN  
FOAM BOARD  
AP KI-94-I - VERSION 0.2

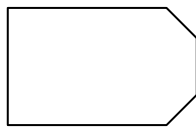

28 ELECTRONICS BAY PIN  
FOAM BOARD  
2 AP KI-94-I - VERSION 0.2

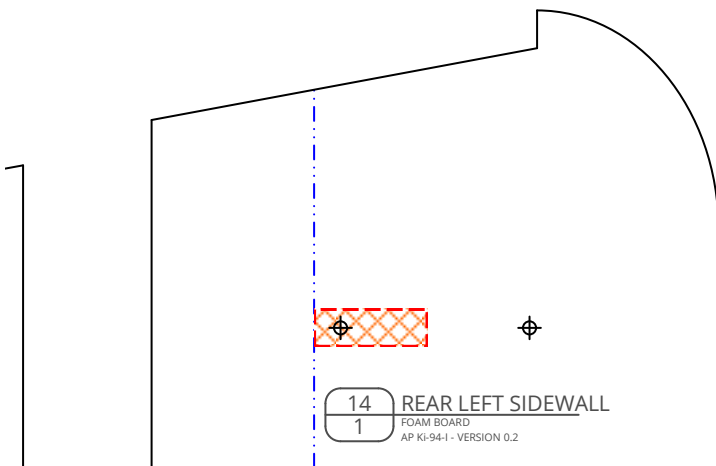

14 REAR LEFT SIDEWALL  
FOAM BOARD  
1 AP KI-94-I - VERSION 0.2

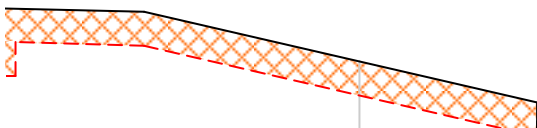

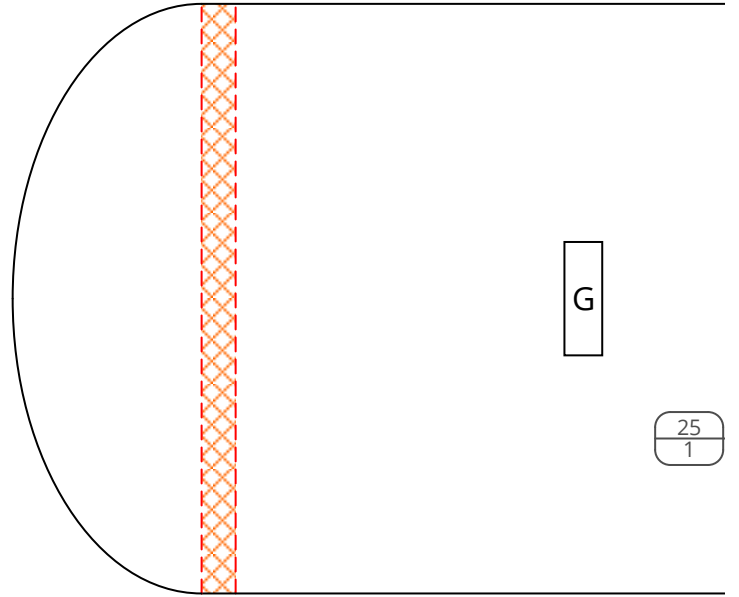
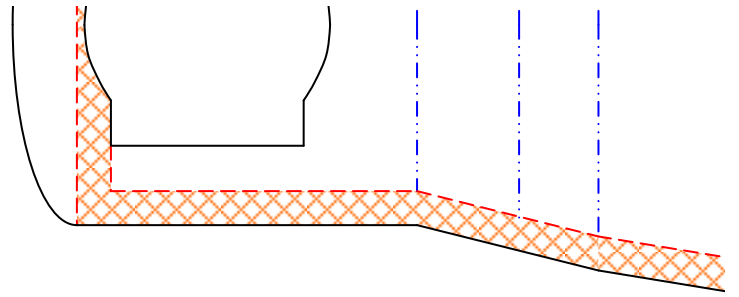

25  
1



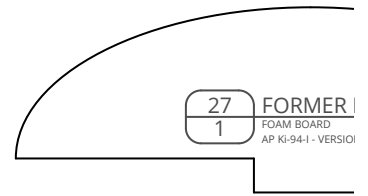
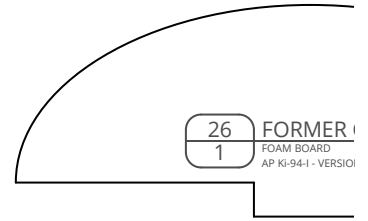
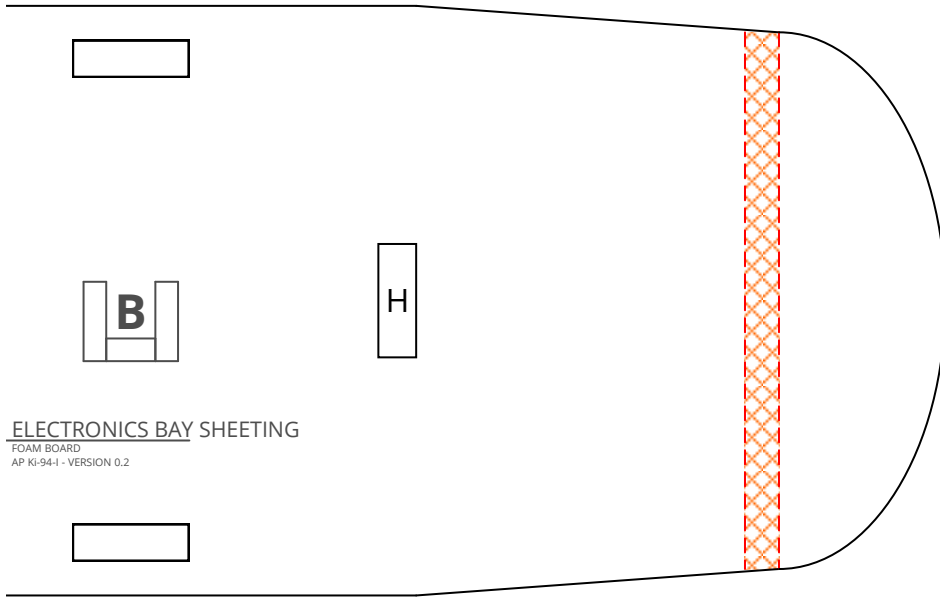
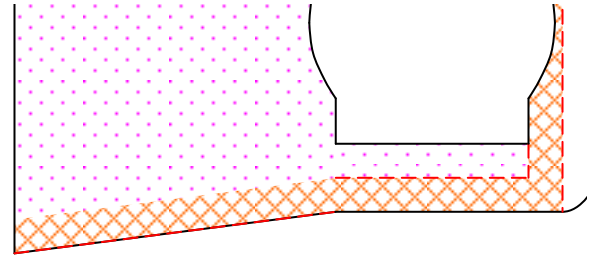
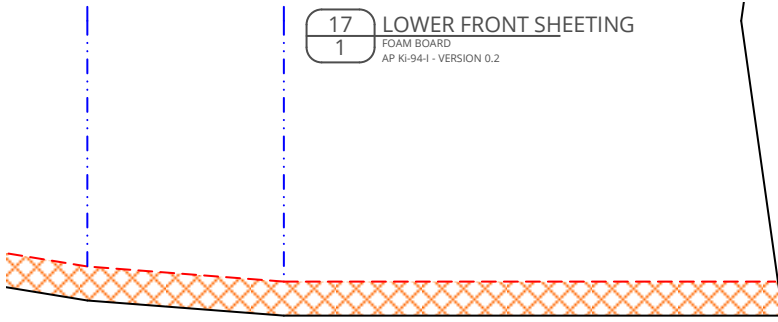

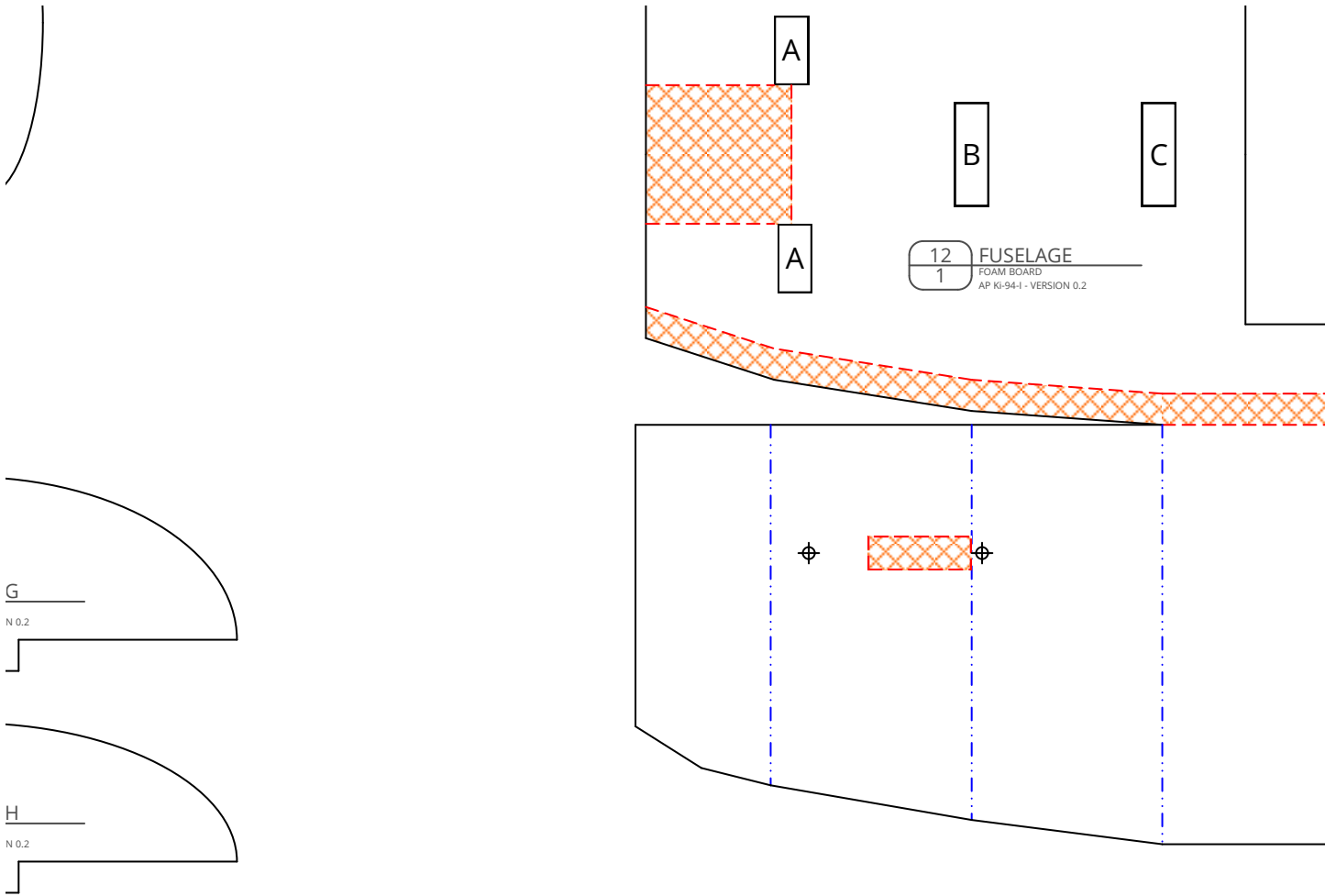

Copyright © 2017 Air Pirates. Plans provided free of charge. Copies allowed for personal use only. Not for commercial use.



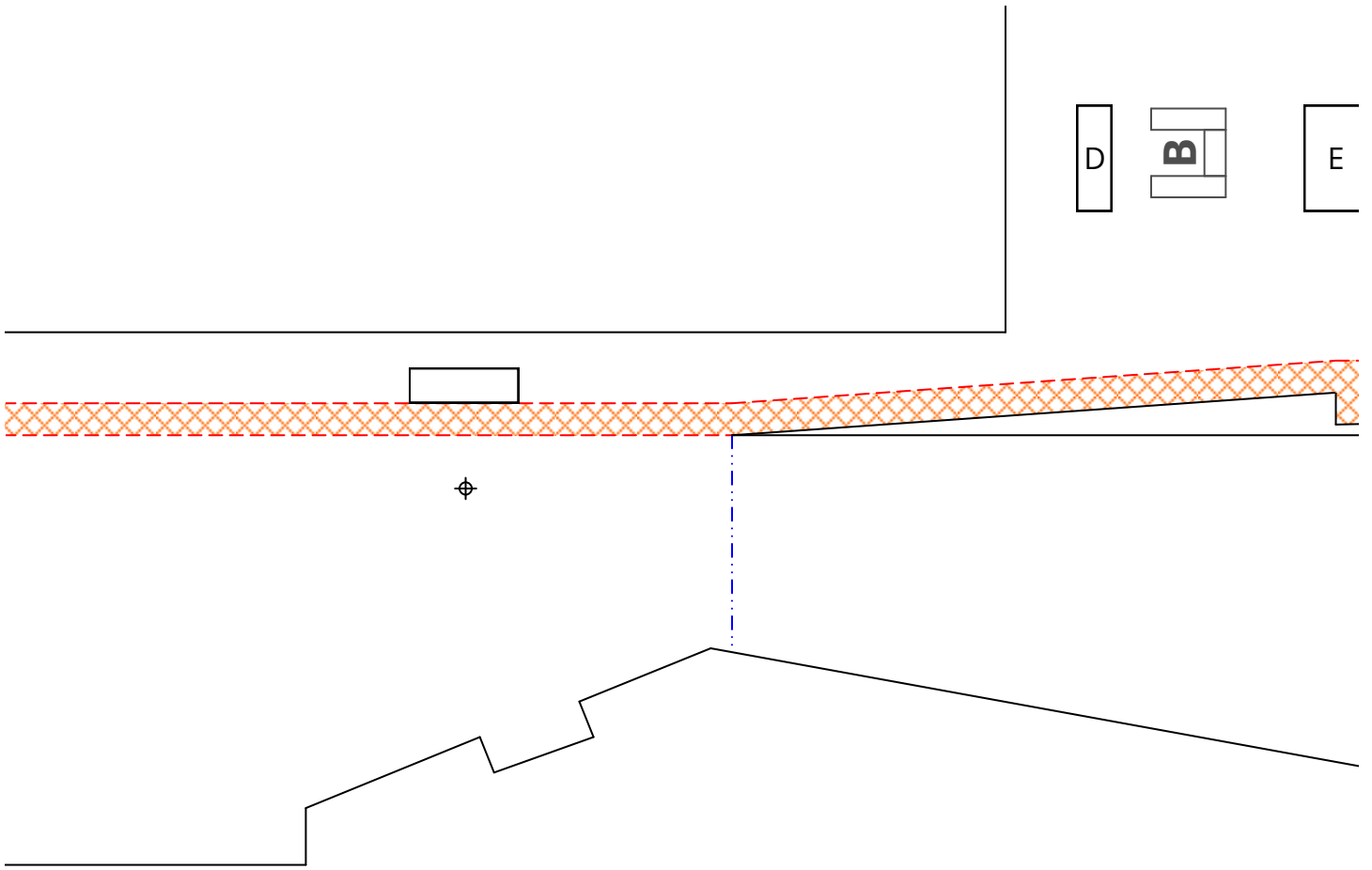

ise.

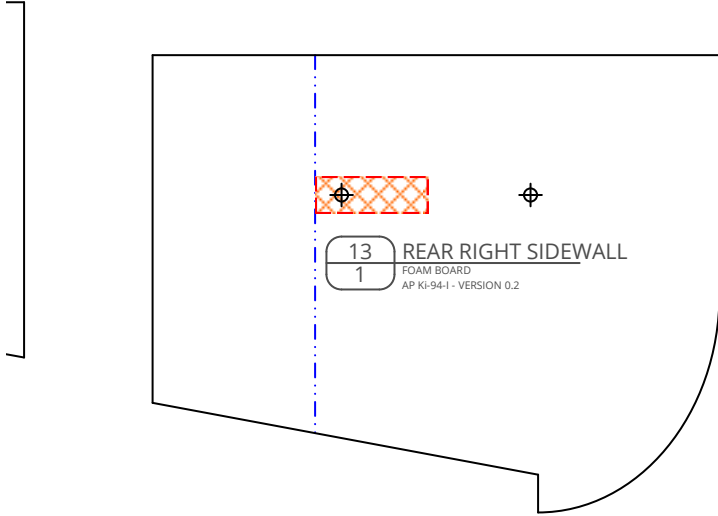
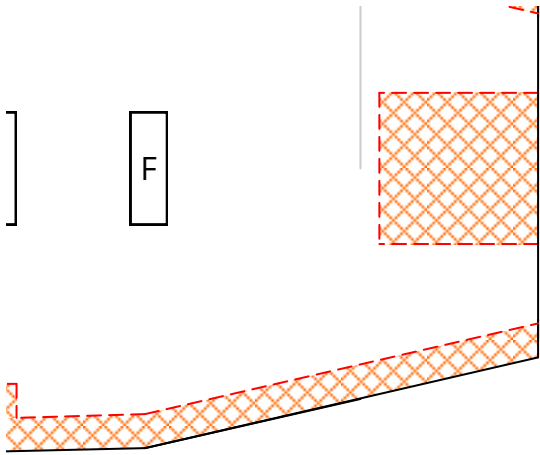

# AP Tachikawa I

Design & Drawing by: Tony Roehling

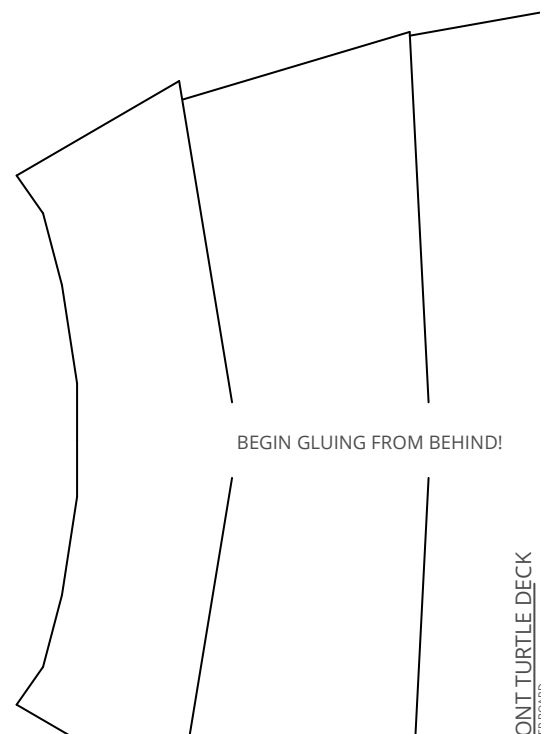

---

# Ki-94-1 ... THE FLYING SUMO FIGHTER - VE

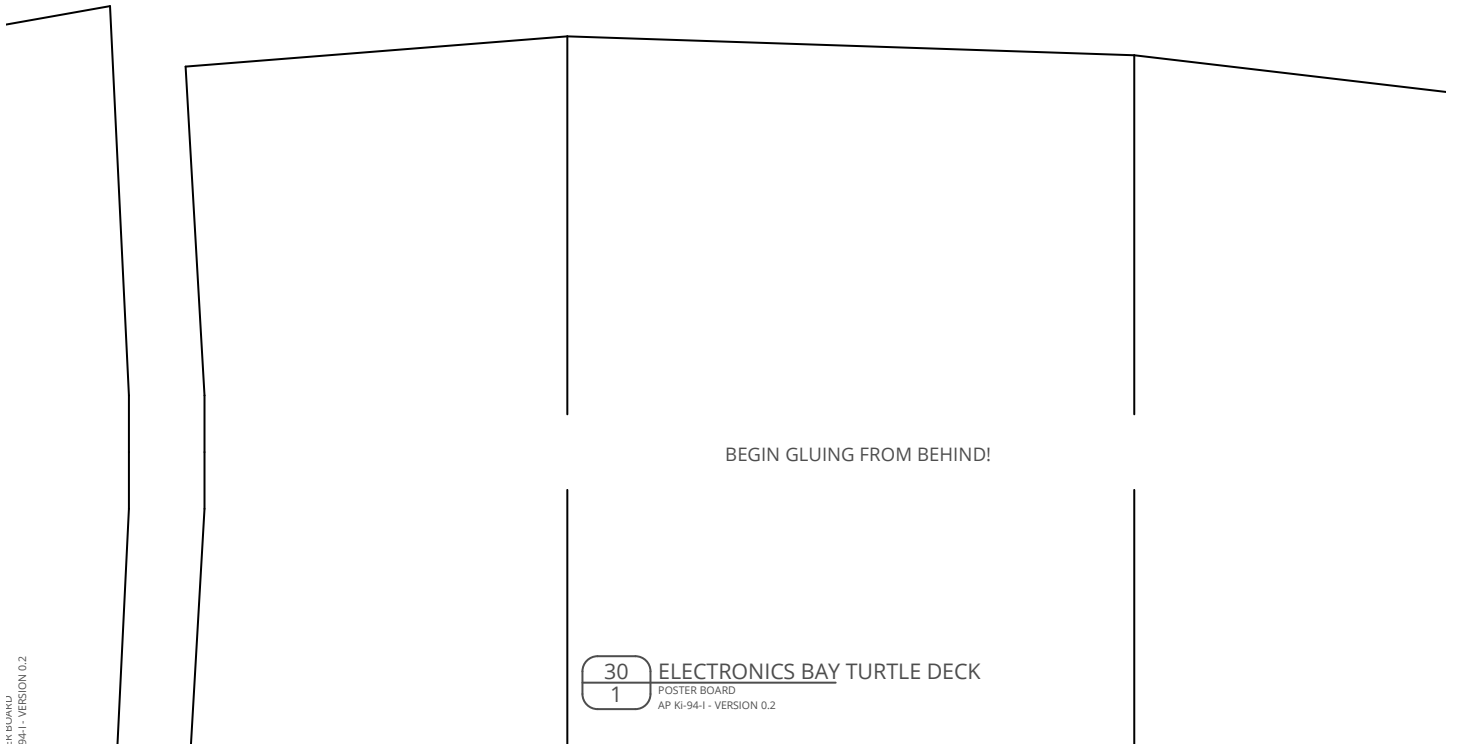

---

# VERSION 0.2 (2018-01-30)

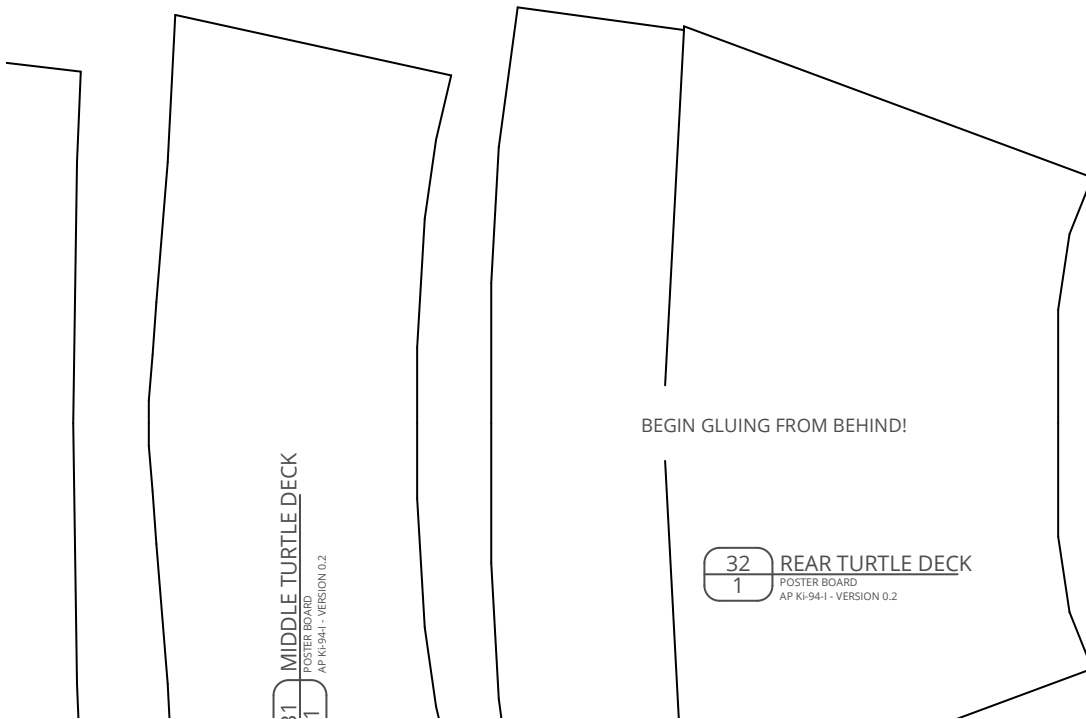

**BI**

in   
cm 

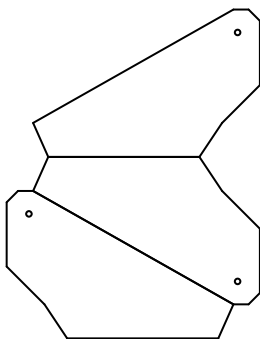

36 CONTROL HORN  
3 PLASTIC CARD  
AP Ki-94-I - VERSION 0.2

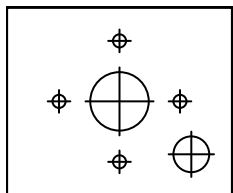

35 MINI FIREWALL  
2 PLYWOOD  
AP Ki-94-I - VERSION 0.2

37 CANOPY MOUNT PIN  
1 BBQ SKEWER  
AP Ki-94-I - VERSION 0.2

SHORTEN THESE PINS TO THE WIDTH OF TH



38 POWER POD MOUNT PIN  
4 BBQ SKEWER  
AP Ki-94-I - VERSION 0.2



39 LOWER GUN  
2 BBQ SKEWER  
AP Ki-94-I - VERSION 0.2



ETA



1E FUSELAGE



---

## TEMPLATES FOR CUTTI

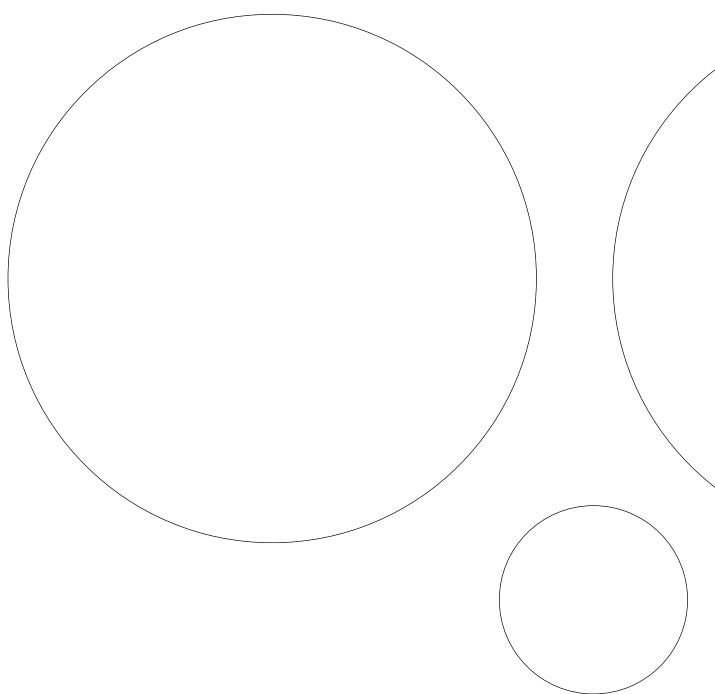

---

## STICKERS

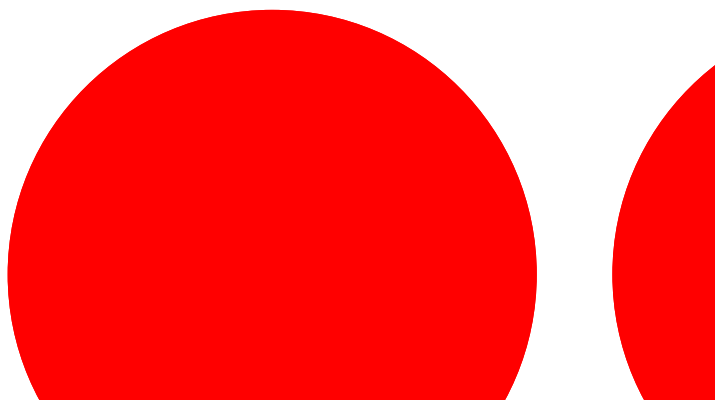



1  
mm  
APR 06



# NG ADESIVE FILM

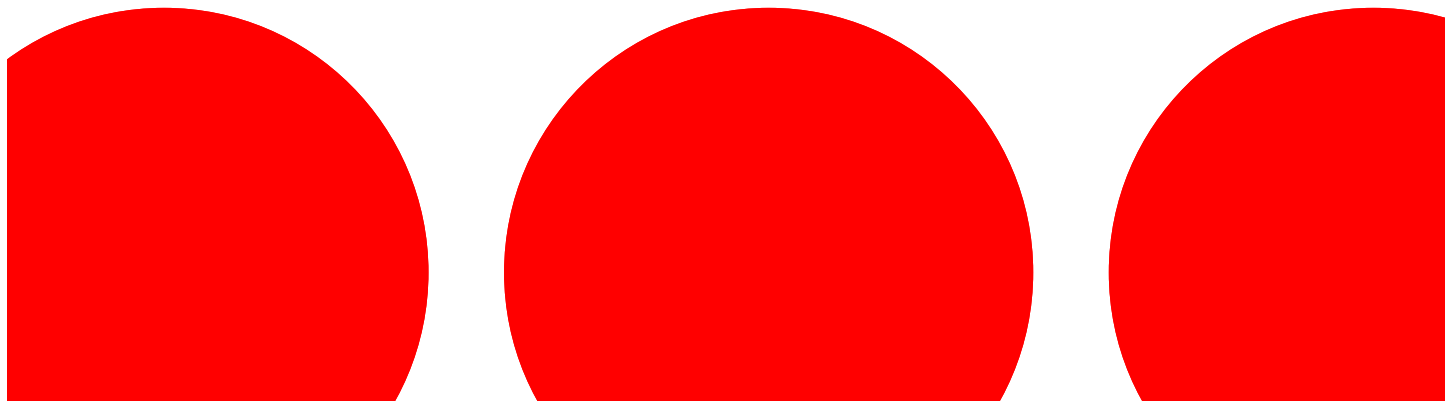
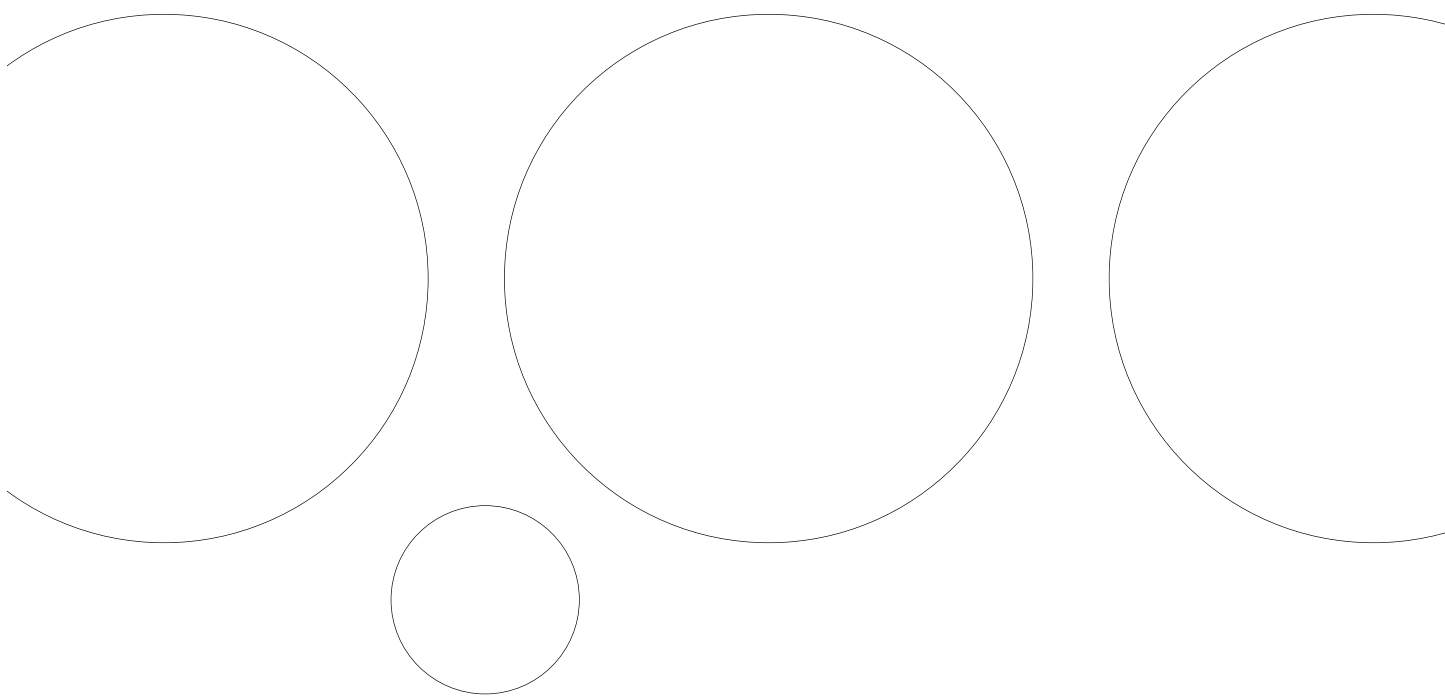

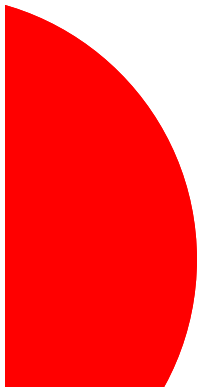
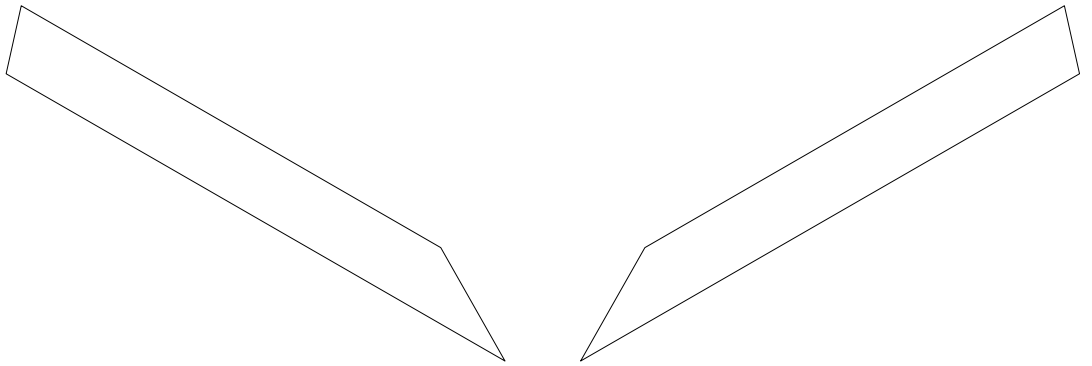
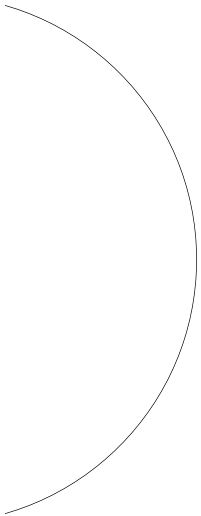
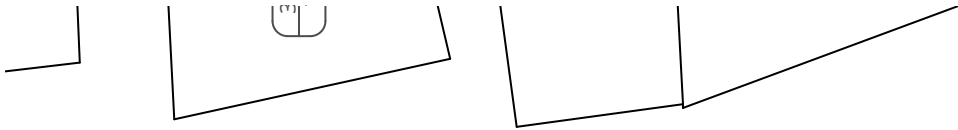

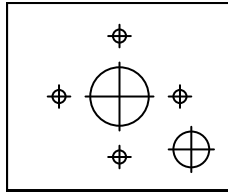

35 MINI FIREWALL  
2 PLYWOOD  
AP Ki-94-1 - VERSION 0.2

40 UPPER GUN  
2 BBQ SKEWER  
AP Ki-94-1 - VERSION 0.2

41 ANTENNA  
1 BBQ SKEWER  
AP Ki-94-1 - VERSION 0.2

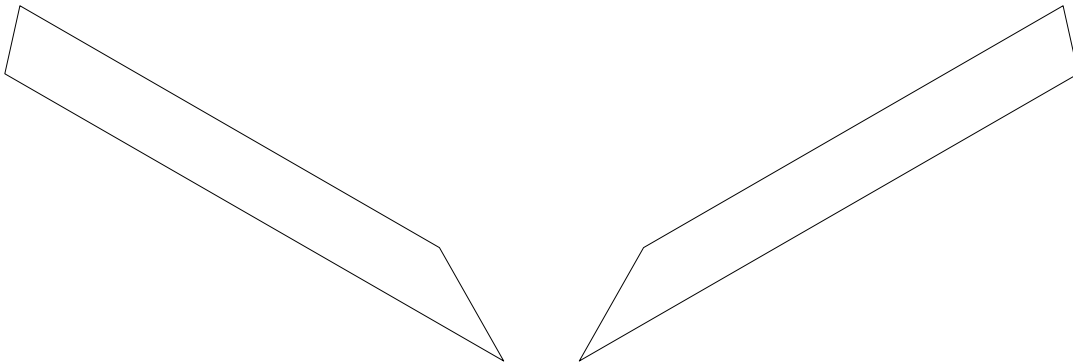



---

---



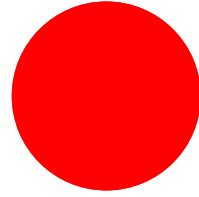
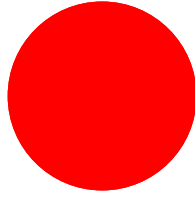

[airc-pirates.com](http://airc-pirates.com)

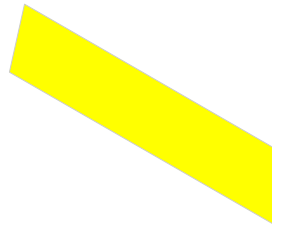
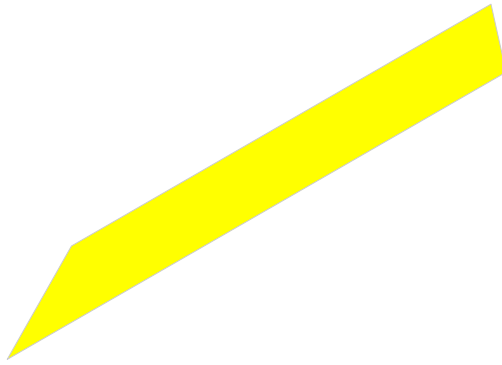
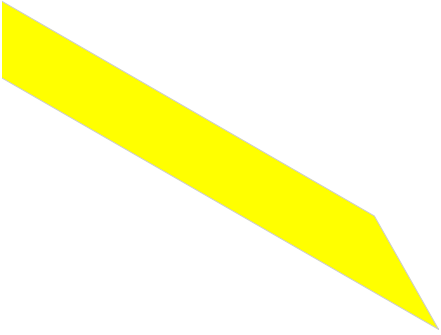
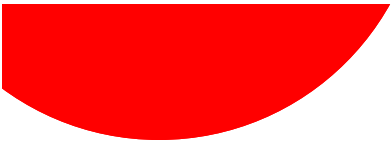

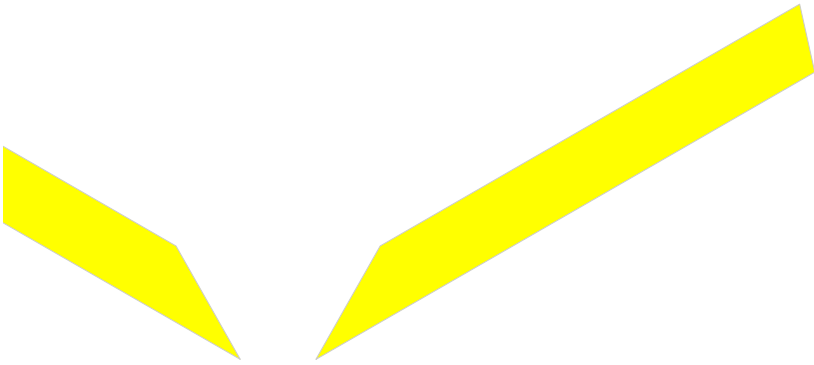

ise.

---



