

# AP Hornet - LASER CANNONS - VERSION 1.0 (2)

Design & Drawing by: Tony Roehling

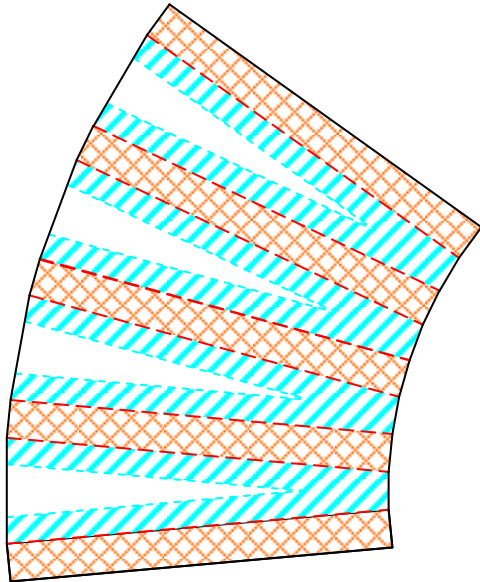

L07 TIP  
2  
FOAM BOARD  
AP ... HORNET - VERSION 1.0

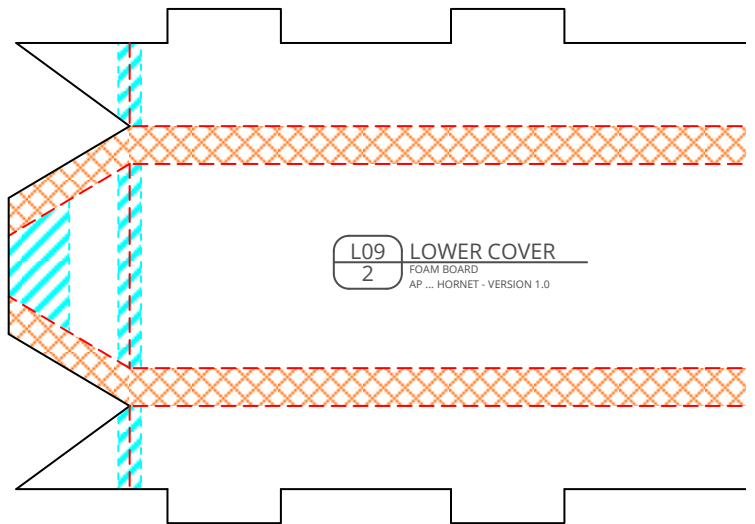

L09 LOWER COVER  
2  
FOAM BOARD  
AP ... HORNET - VERSION 1.0

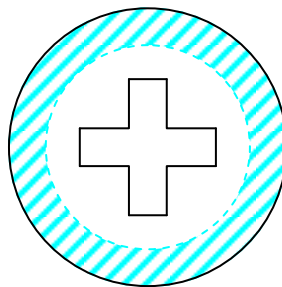

L06 PLATE D  
2  
FOAM BOARD  
AP ... HORNET - VERSION 1.0



L03 PLATE A  
2  
FOAM BOARD  
AP ... HORNET - VERSION 1.0

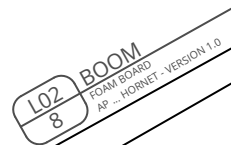

L02 BOOM  
8  
FOAM BOARD  
AP ... HORNET - VERSION 1.0

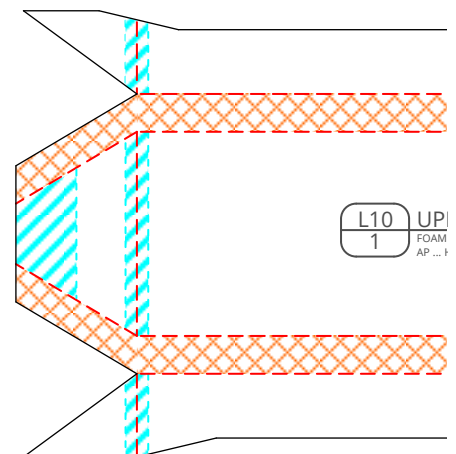

L10 UPPER COVER  
1  
FOAM BOARD  
AP ... HORNET - VERSION 1.0

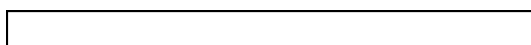

L08 GROOVE FILLER  
2  
FOAM BOARD  
AP ... HORNET - VERSION 1.0



airc-pirates.com

Copyright © 2014

2019-04-05)

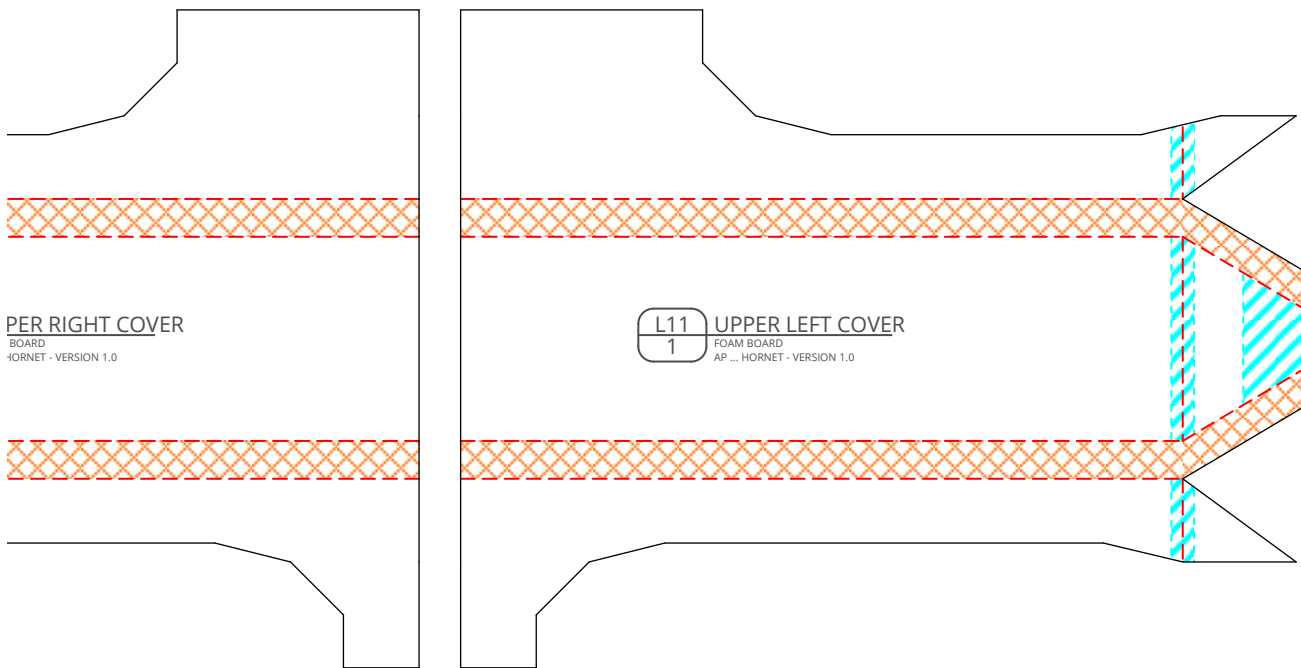
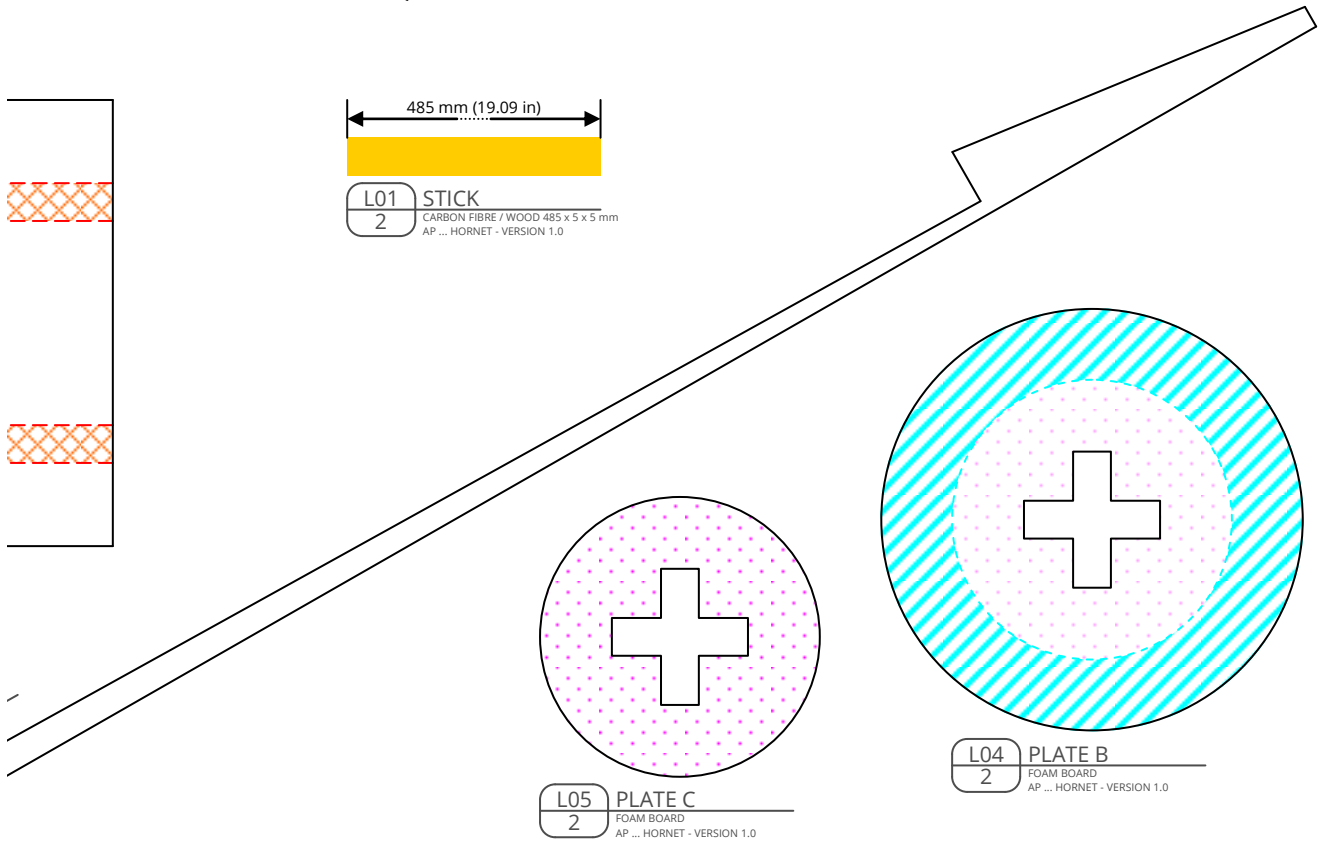
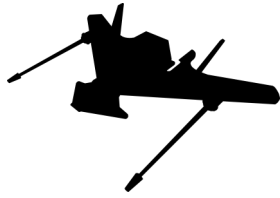

# AP Hornet - LASER CANNONS - VERSION 1.0 (2)

Design & Drawing by: Tony Roehling

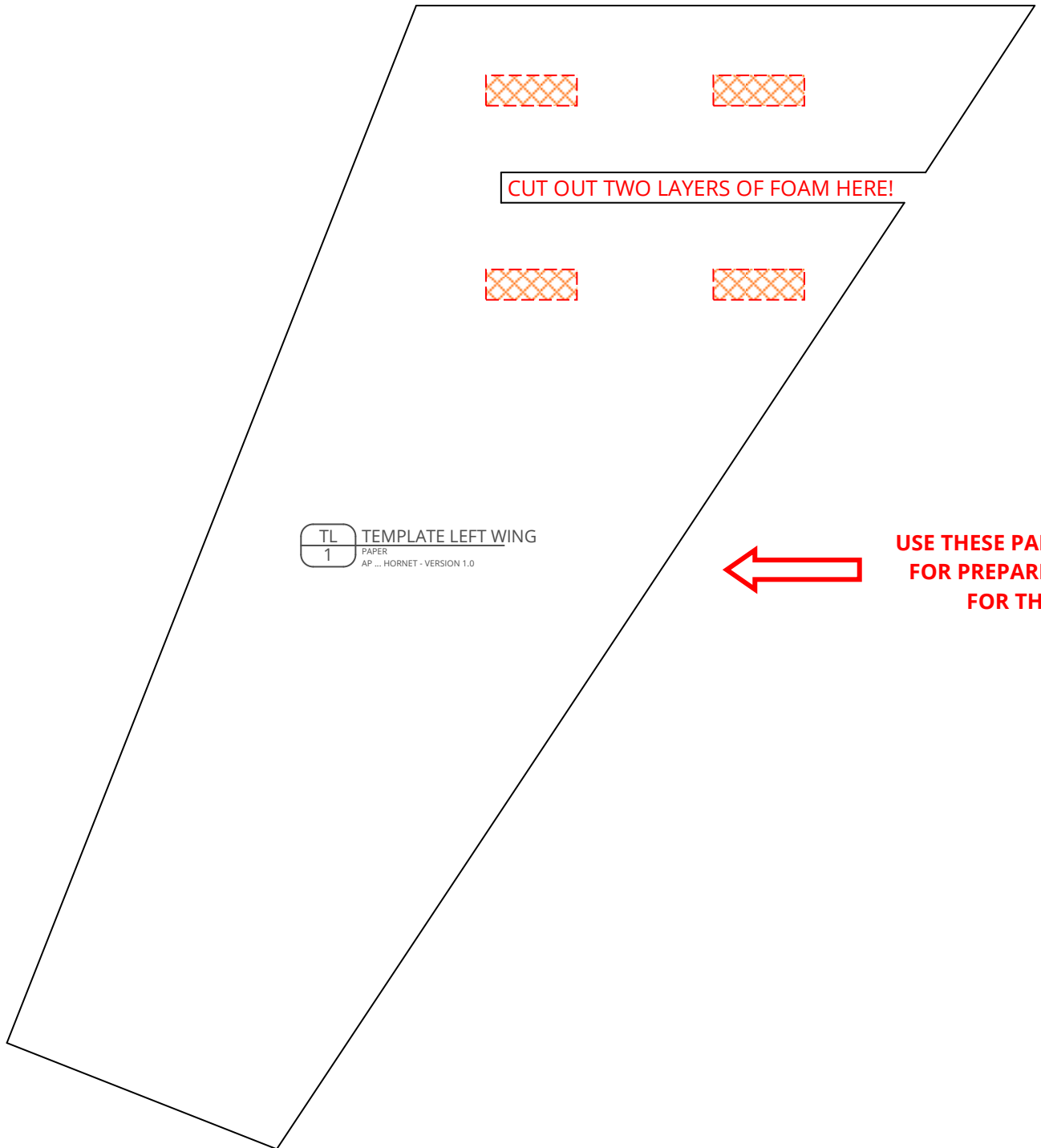

2019-04-05)

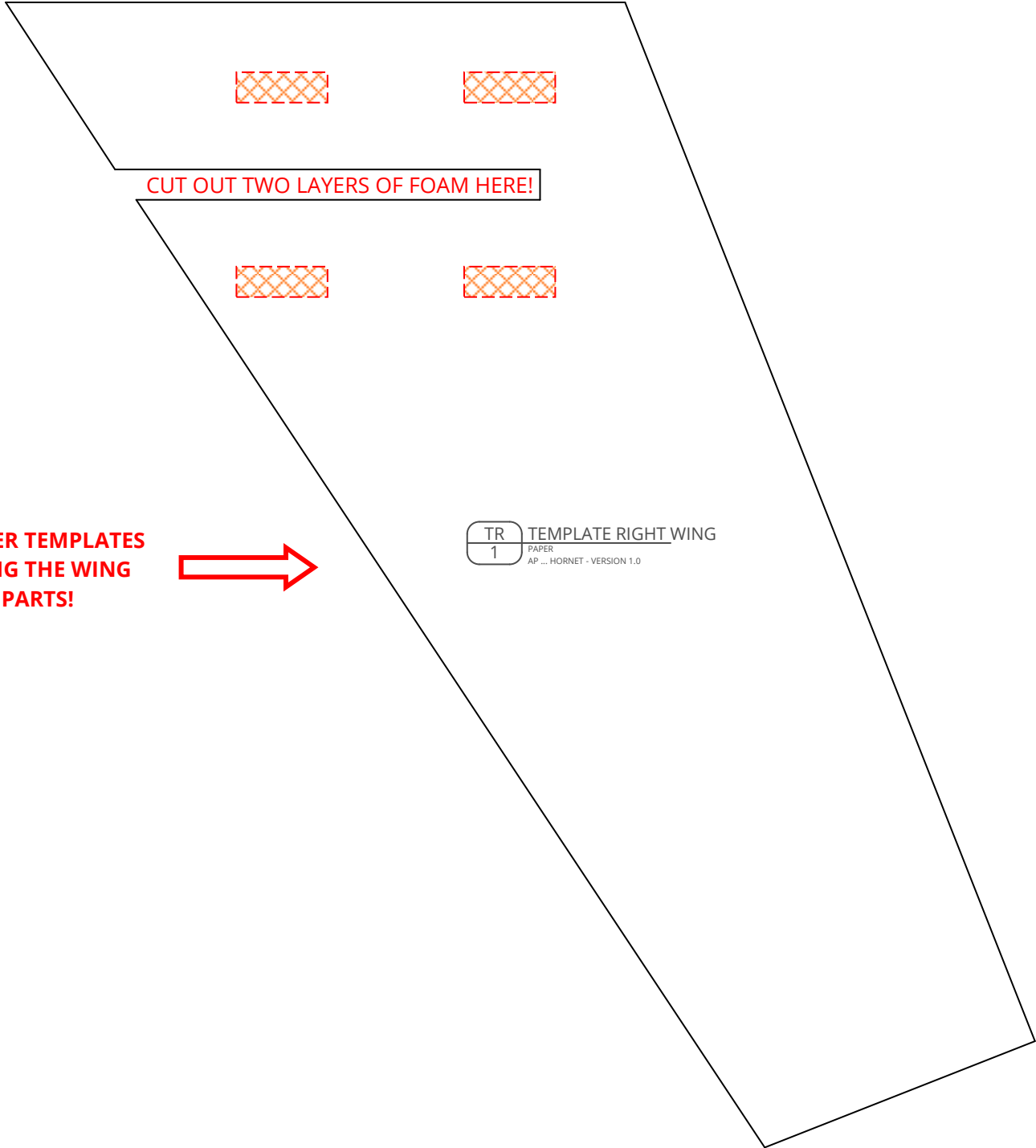
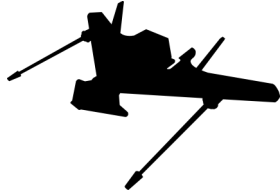

CUT OUT TWO LAYERS OF FOAM HERE!

**OTHER TEMPLATES  
FOR CUTTING THE WING  
PARTS!**



TR 1 TEMPLATE RIGHT WING  
PAPER  
AP ... HORNET - VERSION 1.0