



airc-pirates.com

AP Mini Mirage

Version 1.1 (2017-12-23)

Design & Drawing by: Tony Roehling



SPECS

WINGSPAN: 520 mm | 20.47 in
CG: 124 mm | 4.88 in (from air intake)
LENGTH: 700 mm | 27.56 in
DRY WEIGHT: 205 g | 7.23 oz (without fuel tanks)
ALL UP WEIGHT: 275 g | 9.7 oz (with 3S 850 mAh | without fuel tanks)
EXPO: 30 %
CHANNELS: 3 (THR | AIL | ELV)

ELECTRONICS

MOTOR: 2300 kv (1806 or 2204)
PROPELLER: 5x5 or 6x4
ESC: 12 A
SERVOS: 2 x 5 g
BATTERY: 850 mAh 3S



DRAWING KEY

... is based on the Flite Test Drawing Key by Dan Sponholz

FOLD TYPES

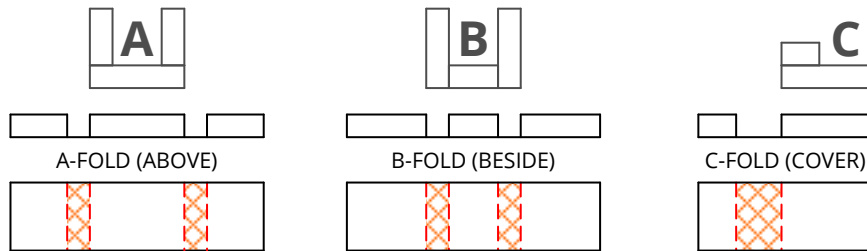

LINE TYPE/COLOR

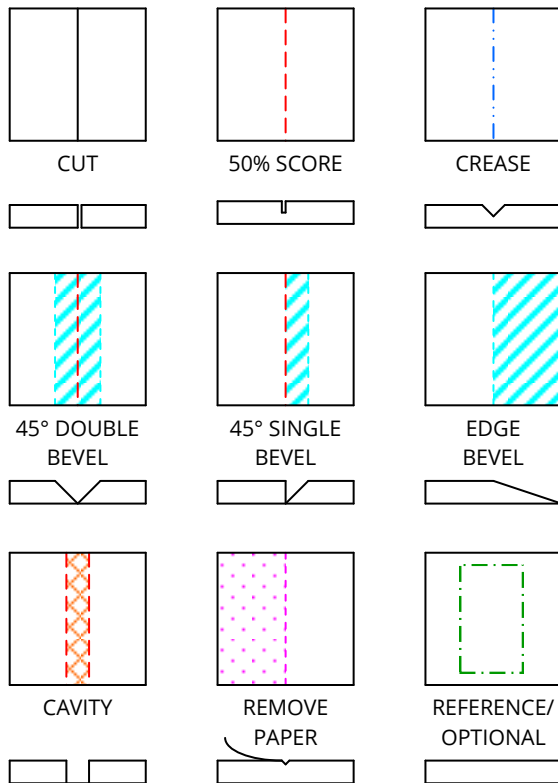

SYMBOLS

PART NUMBER

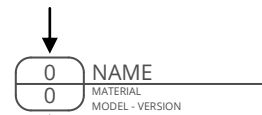

QUANTITY



DOWEL HOLE



CENTER OF GRAVITY (CG)

AP Mini Mirage - PARTS LIST

Version 1.1 (2017-12-23)

| PART NR. | DESCRIPTION | QUANTITY | MATERIAL | SHEET |
|----------|---|----------|------------------|-------|
| 1 | LEFT WING | 1 | FOAM BOARD | 1 |
| 2 | RIGHT WING | 1 | FOAM BOARD | 1 |
| 3 | FRONT SPAR | 2 | FOAM BOARD | 1 |
| 4 | REAR SPAR | 2 | FOAM BOARD | 1 |
| 5 | NOSE | 1 | FOAM BOARD | 1 |
| 6 | NOSE SHEETING | 1 | FOAM BOARD | 1 |
| 7 | LEFT AIR INTAKE CONE | 1 | FOAM BOARD | 1 |
| 8 | RIGHT AIR INTAKE CONE | 1 | FOAM BOARD | 1 |
| 9 | LEFT SIDEWALL | 1 | FOAM BOARD | 2 |
| 10 | RIGHT SIDEWALL | 1 | FOAM BOARD | 2 |
| 11 | AIR INTAKE SCALE PART | 2 | FOAM BOARD | 2 |
| 12 | LOWER REAR SHEETING | 1 | PLASTIC CARD | 2 |
| 13 | VERTICAL SPACER | 1 | FOAM BOARD | 2 |
| 14 | HORIZONTAL SPACER | 2 | FOAM BOARD | 2 |
| 15 | MINI POWER POD | 1 | FOAM BOARD | 2 |
| 16 | MINI FIREWALL | 1 | PLYWOOD max. 5mm | 2 |
| 17 | POWER POD MOUNT PIN | 2 | BBQ SKEWER | 2 |
| 18 | TOP SHEETING | 1 | FOAM BOARD | 2 |
| 19 | VERTICAL STABILIZER | 1 | FOAM BOARD | 2 |
| 20 | V-STAB SCALE PART | 2 | FOAM BOARD | 2 |
| 21 | REAR CANOPY MOUNT | 1 | FOAM BOARD | 2 |
| 22 | FRONT CANOPY MOUNT | 1 | FOAM BOARD | 2 |
| 23 | CANOPY | 1 | FOAM BOARD | 2 |
| 24 | FUEL HOSE | 1 | FOAM BOARD | 2 |
| 25 | CANOPY MOUNT PIN | 1 | BBQ SKEWER | 2 |
| 26 | CONTROL HORN | 2 | PLASTIC CARD | 2 |
| G1 | ELEVON NEUTRAL GAUGE | 1 | FOAM BOARD | 1 |
| G2 | THROW GAUGE | 1 | FOAM BOARD | 1 |
| G3 | 90° TRIANGLE | 1 | FOAM BOARD | 2 |
| O1 | FUEL TANK | 2 | FOAM BOARD | 3 |
| O2 | FUEL TANK MOUNT | 2 | FOAM BOARD | 3 |
| T1-T8 | TEMPLATES FOR CUTTING ADESIVE FILM | | | 3 |
| | OTHER MATERIALS | | | |
| | STEEL WIRE (Ø 1mm) FOR THE LINKAGE RODS | | | |
| | VELCRO TO MOUNT THE BATTERY, ESC, ... | | | |

Build the Mini Mirage in the order of the part numbers!

AP Mini Mirage

Design & Drawing by: Tony Roehling

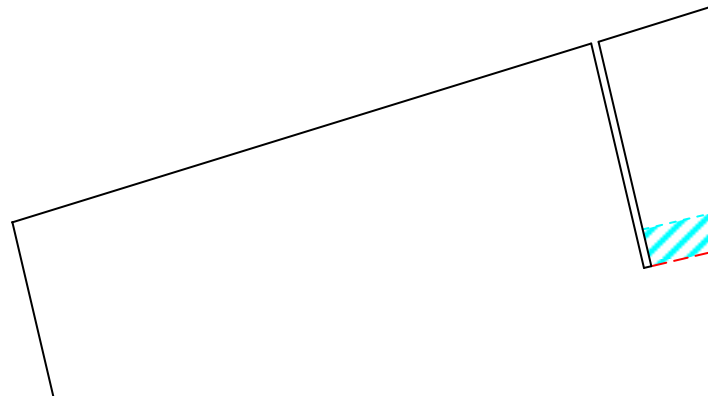

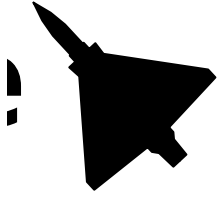

- VERSION 1.1 (2017-12-23)

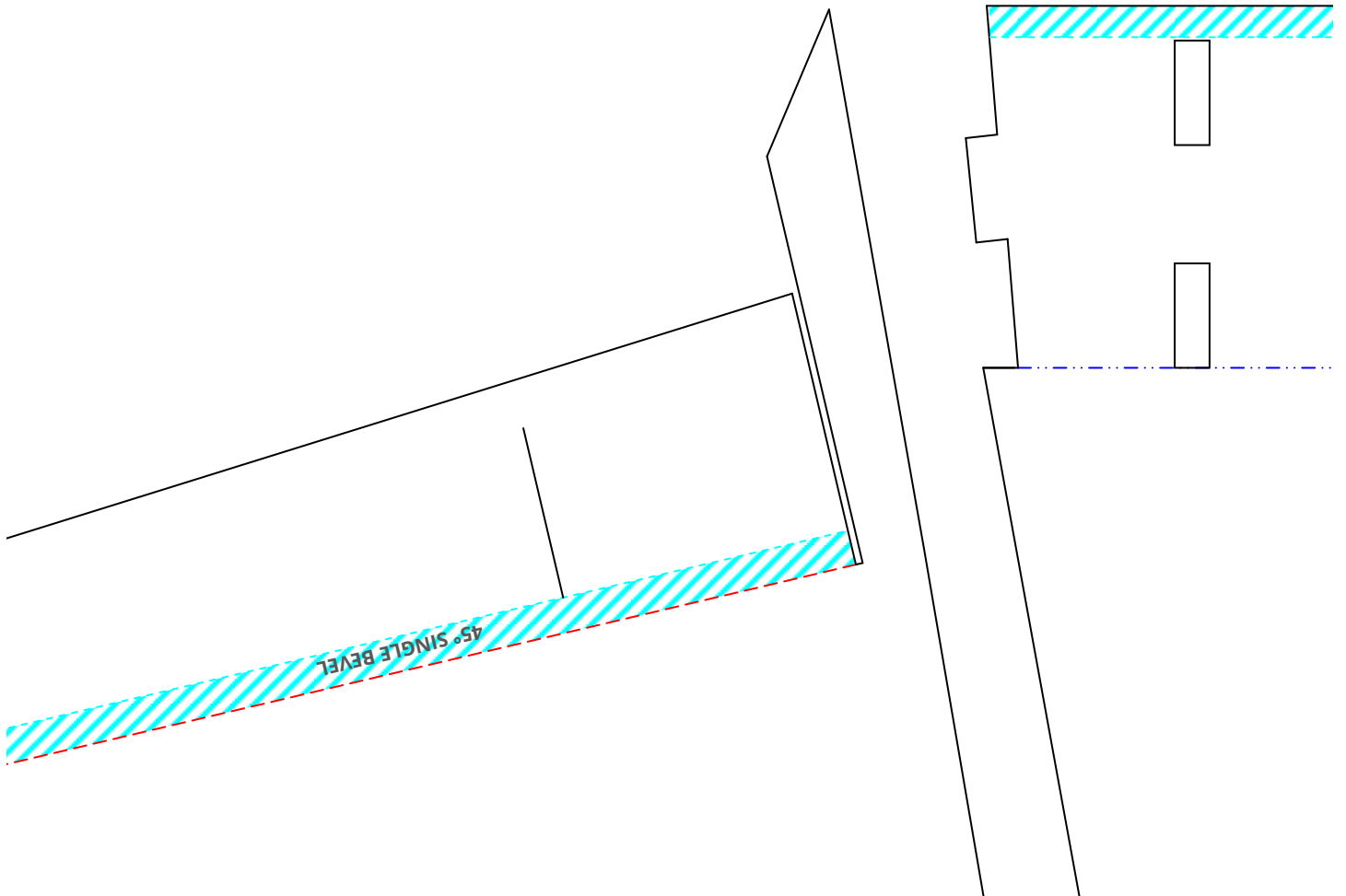

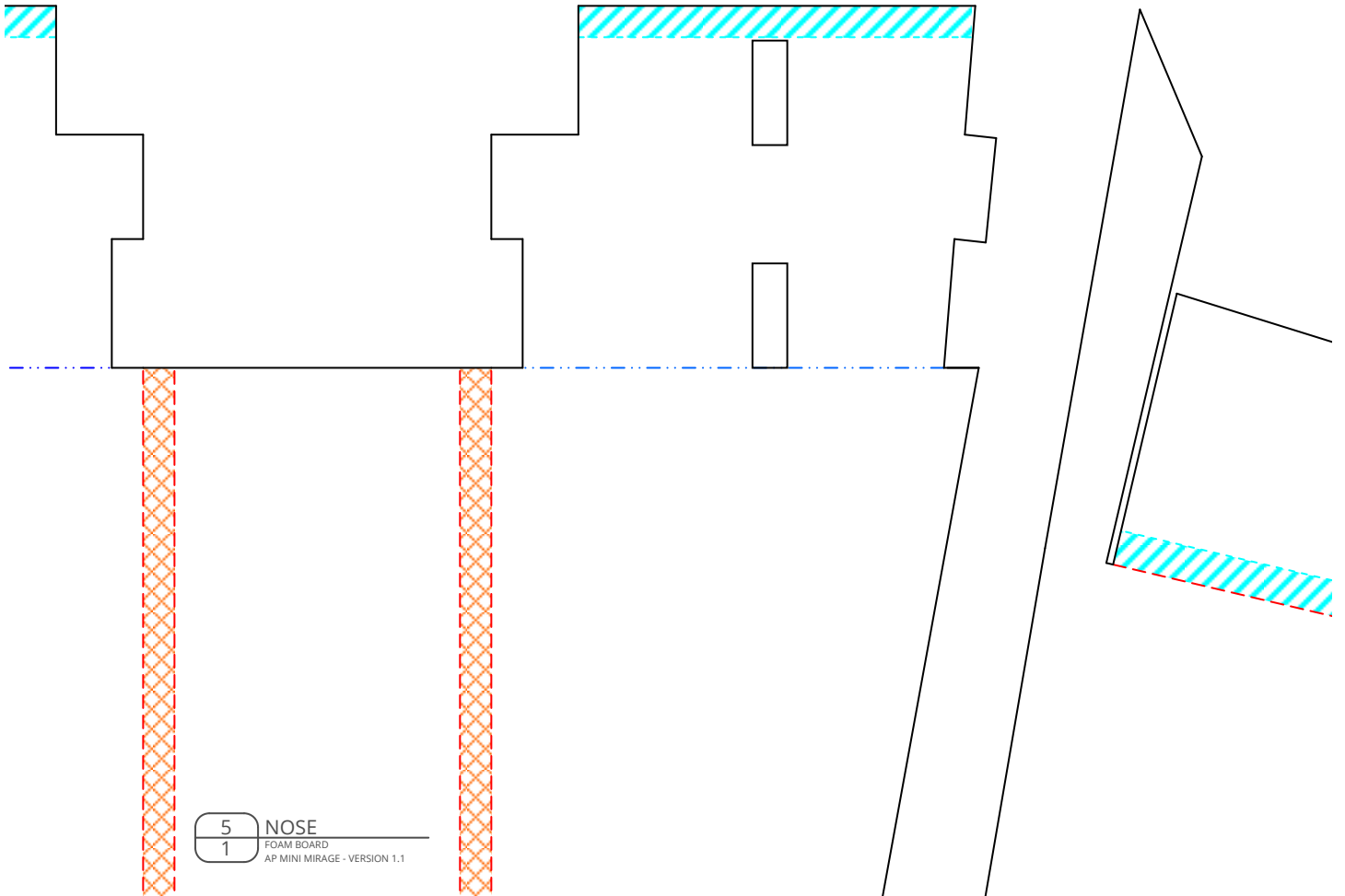

5 NOSE
1 FOAM BOARD
AP MINI MIRAGE - VERSION 1.1

in
cm

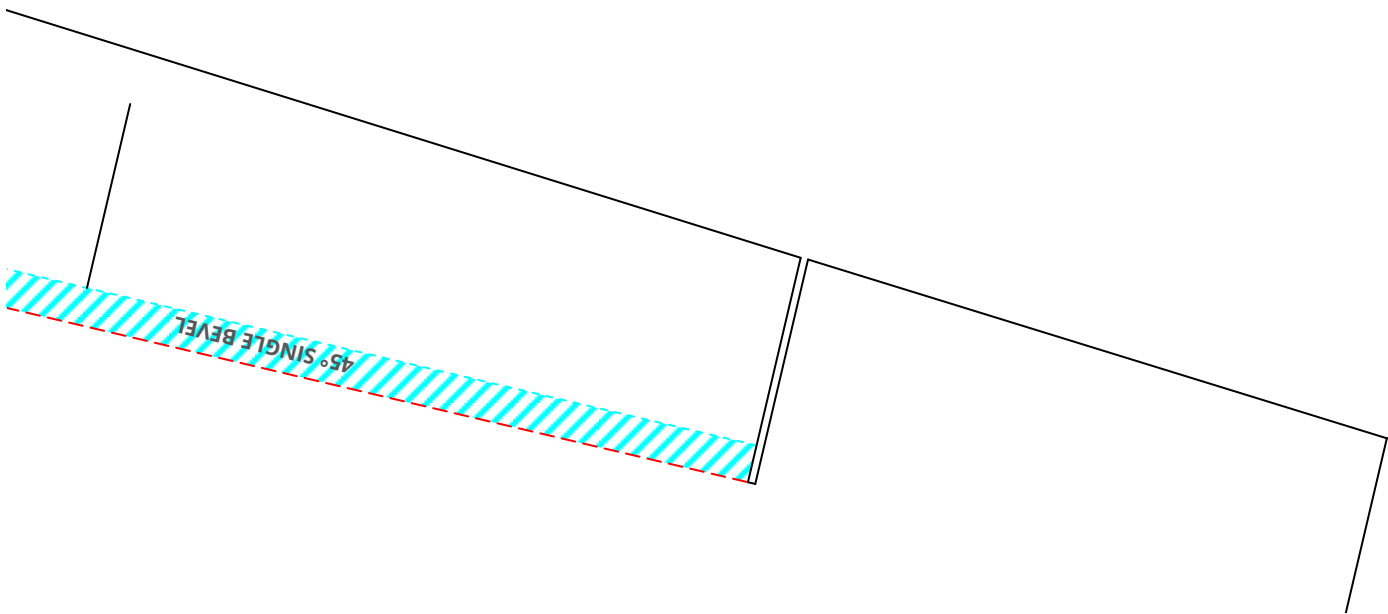

CHOOSE A SERVO SHAPE OR CREATE YOUR OWN!

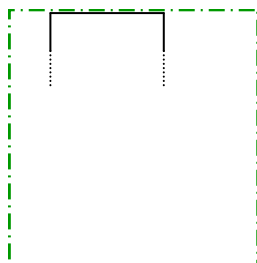
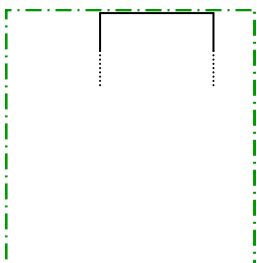
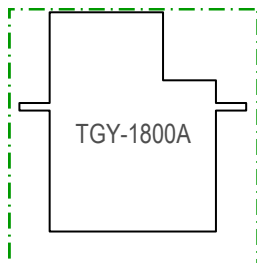
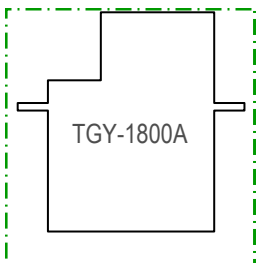
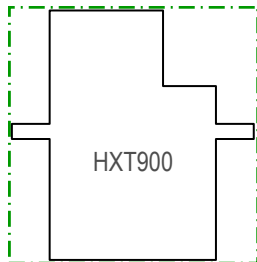
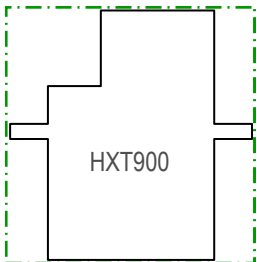

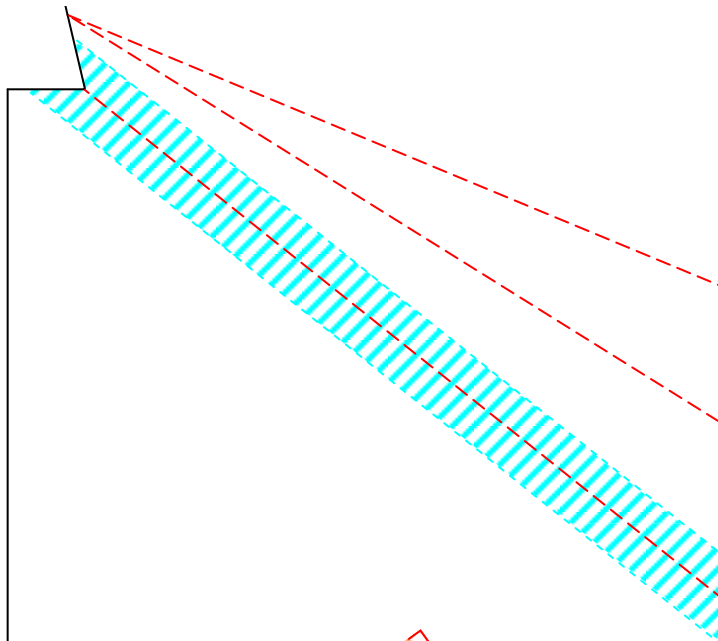

OPTIONAL:
MOUNTING HOLES
FOR FUEL TANKS!

1 LEFT WING
1 FOAM BOARD
AP MINI MIRAGE - VERSION 1.1



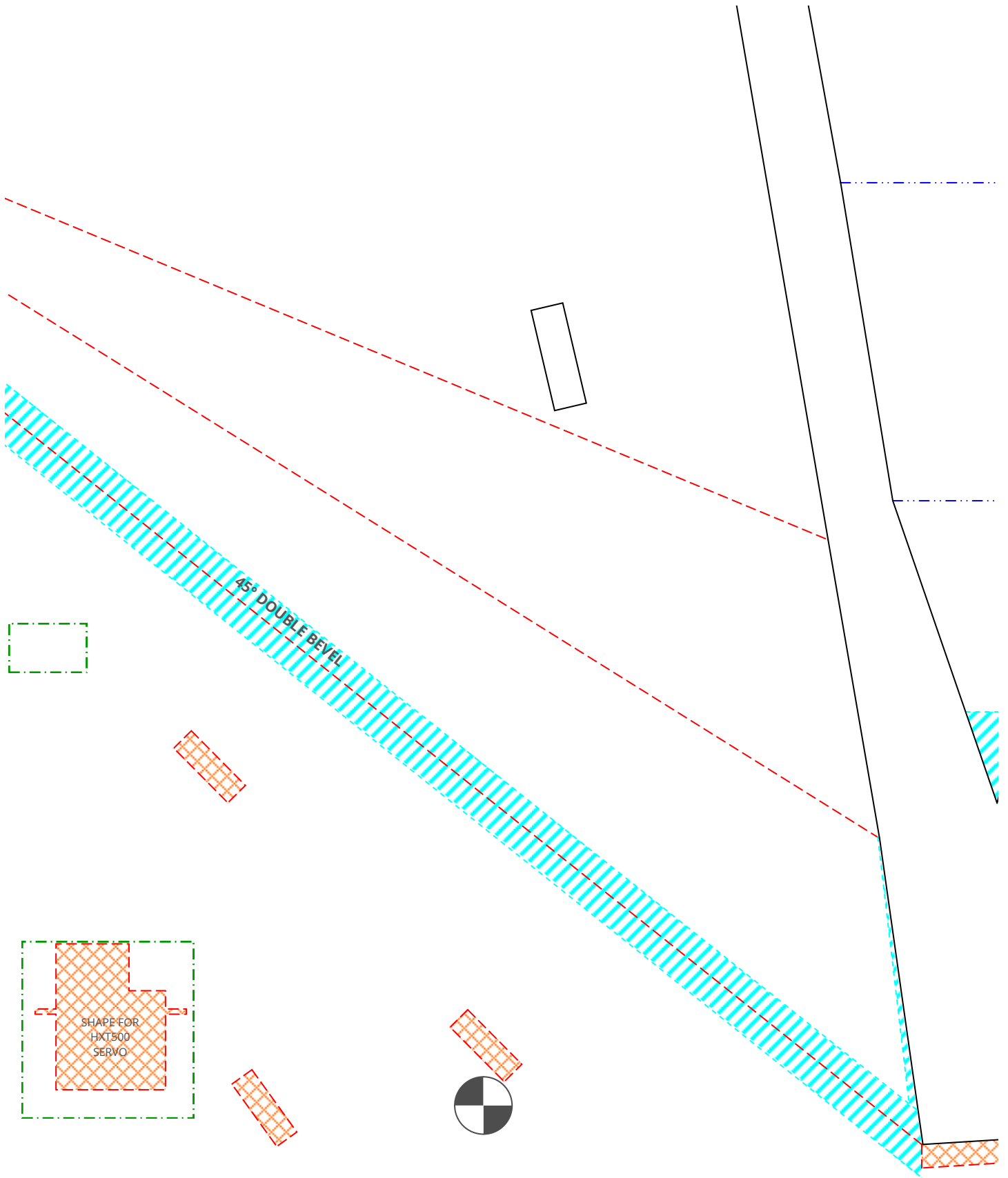

B

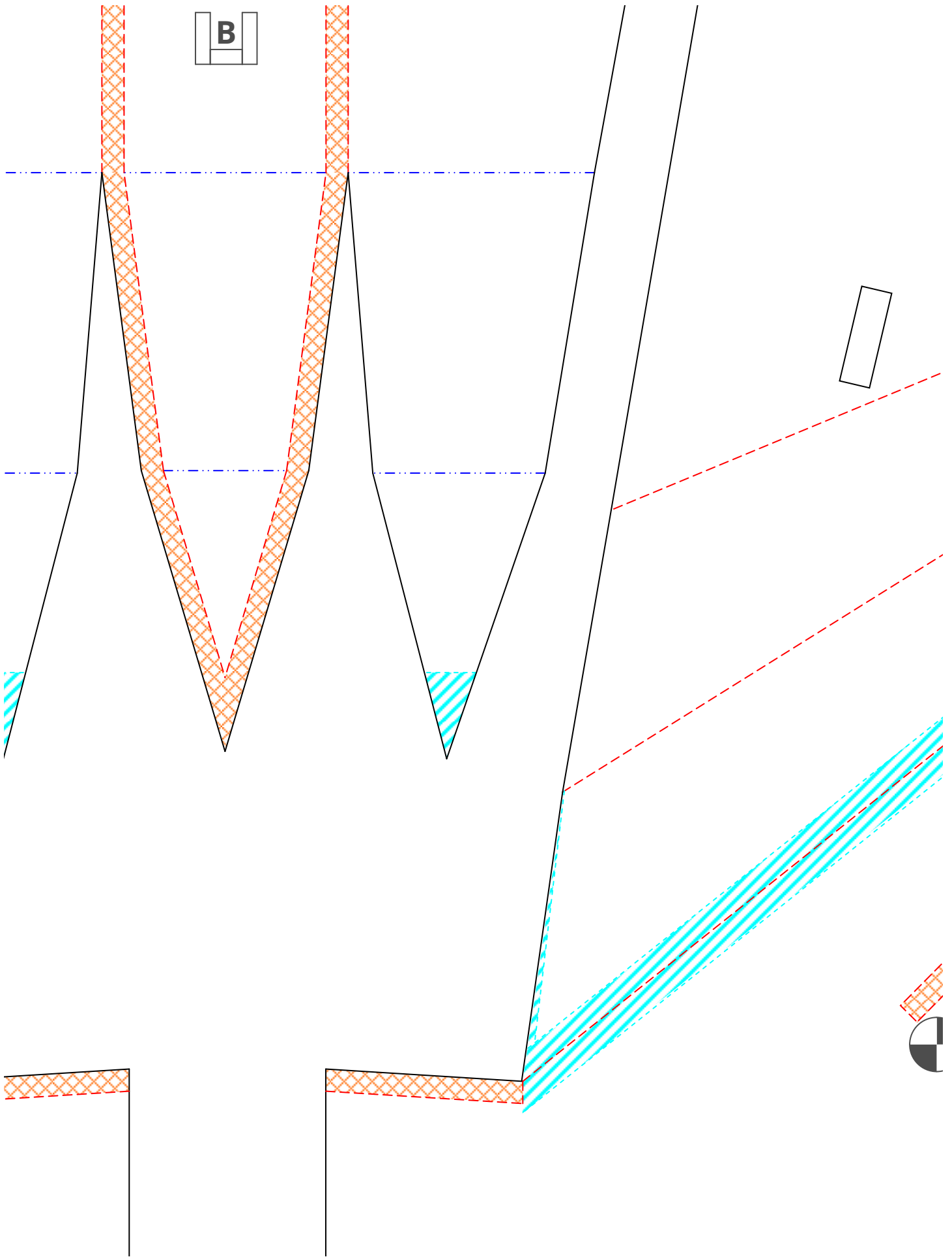

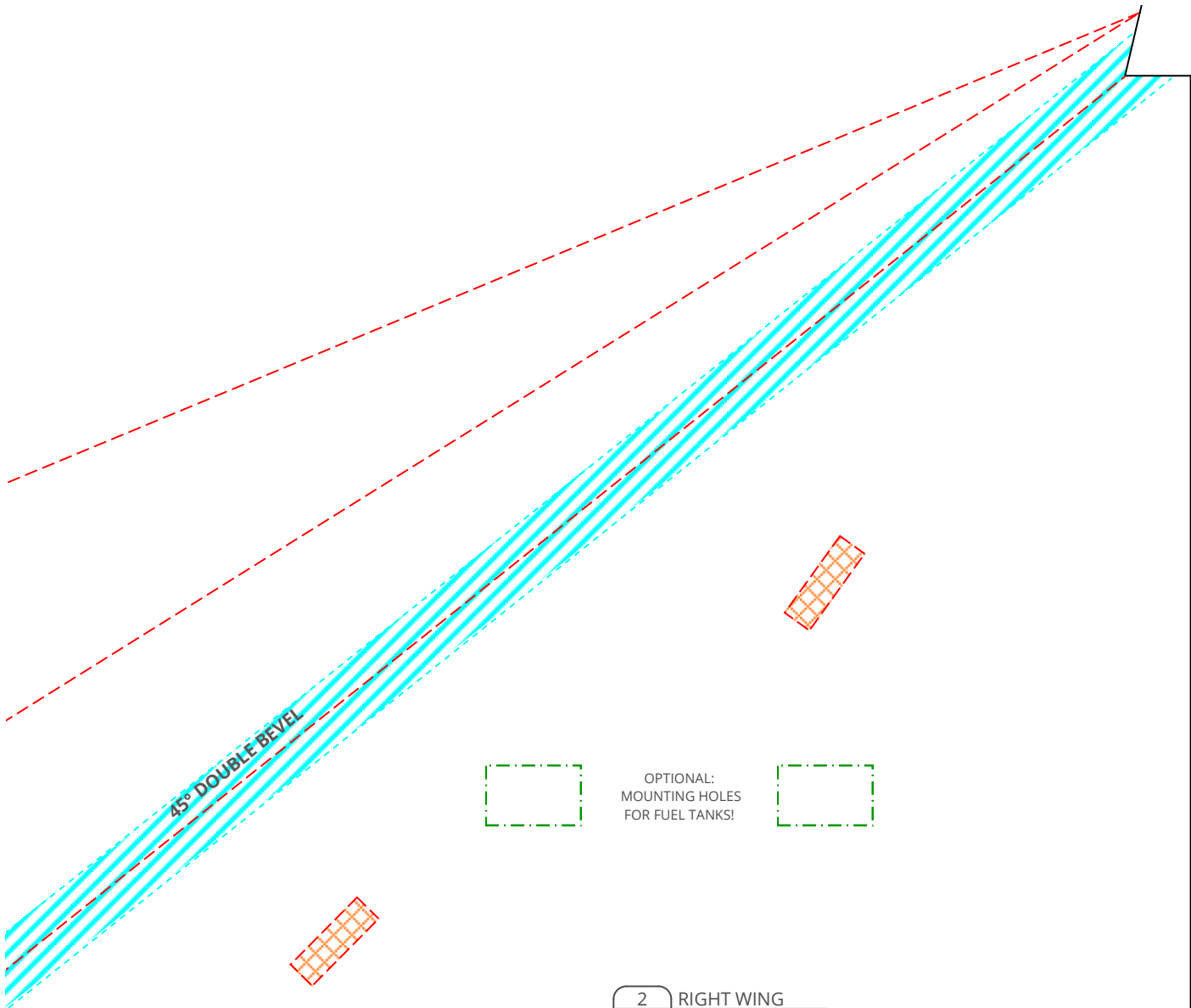

45° DOUBLE BEVEL



OPTIONAL:
MOUNTING HOLES
FOR FUEL TANKS!



2 RIGHT WING
1 FOAM BOARD
AP MINI MIRAGE - VERSION 1.1

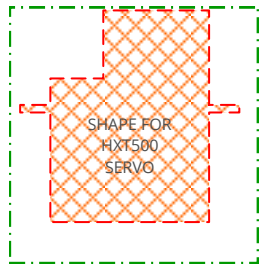

SHAPE FOR
HXT500
SERVO

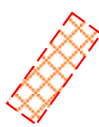

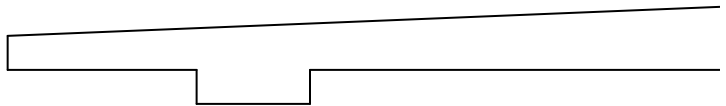
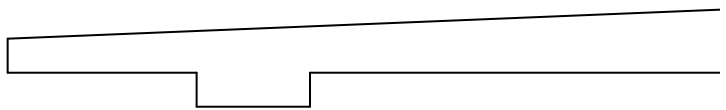
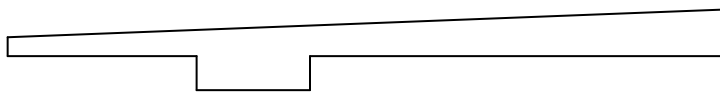
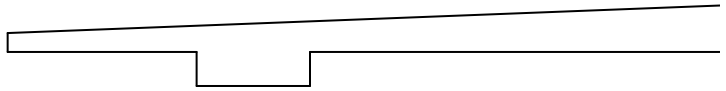

airc-pirates.com



GLUE THE WING PARTS TOGETHER HERE!

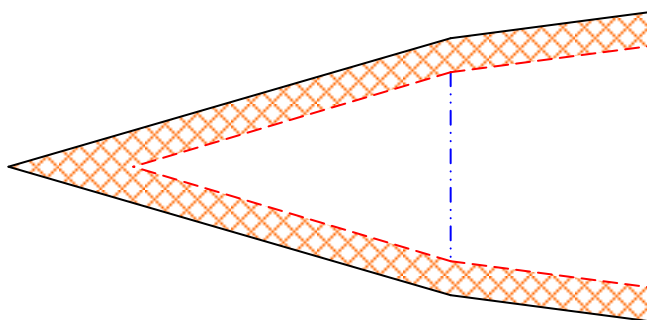
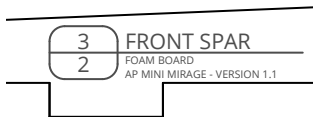
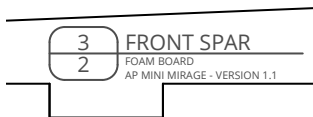
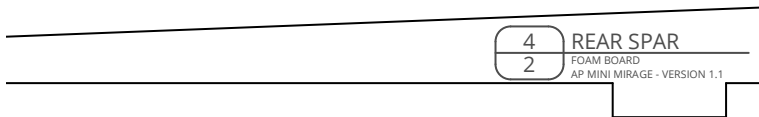
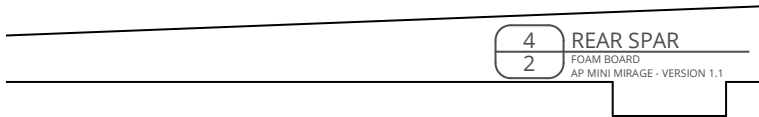

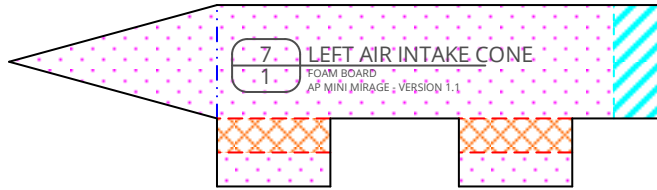
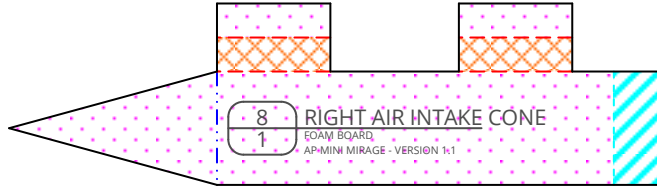
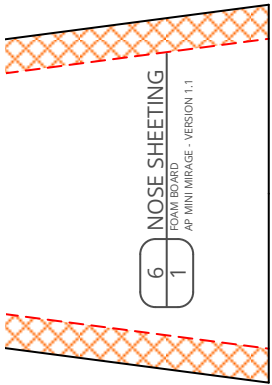
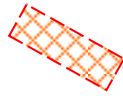

(at the

GLUE THE WING PARTS TOGETHER HERE!

G1 ELEVON NEUTRAL GAUGE
1 FOAM BOARD
AP MINI MIRAGE - VERSION 1.1

4 mm up
at inner edges near the fuselage)

G2 THROW GAUGE
1 FOAM BOARD
AP MINI MIRAGE - VERSION 1.1

10 mm in either direction
(at the inner edges from neutral)

free of charge. Copies allowed for personal use only. Not for commercial use.

AP Mini Mirage

Design & Drawing by: Tony Roehling

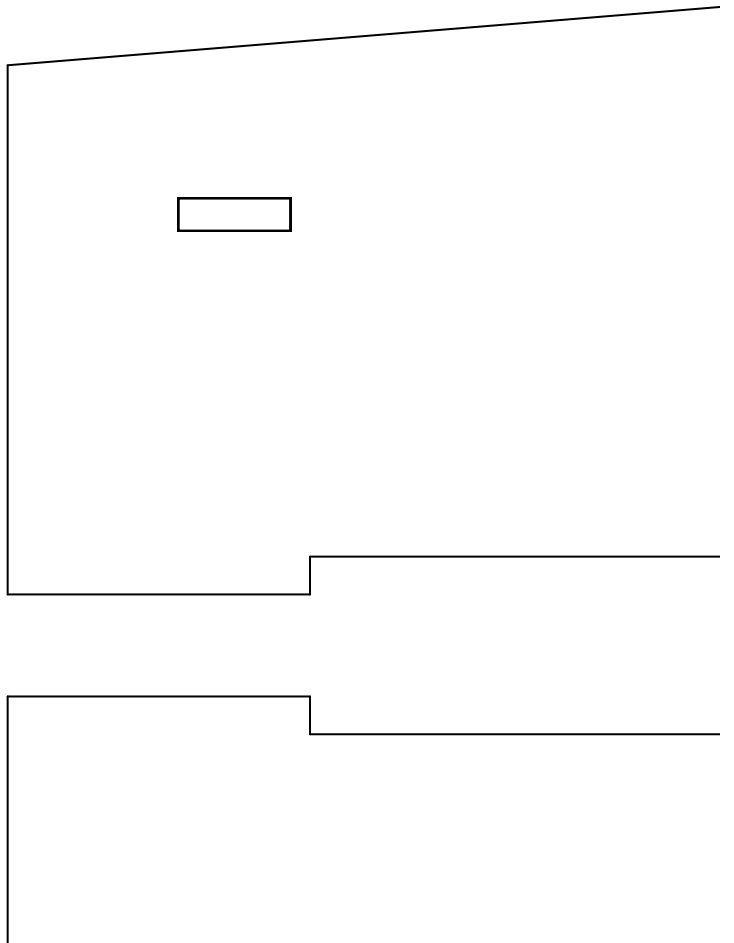

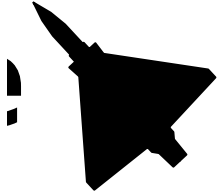

- VERSION 1.1 (2017-12-23)

10 RIGHT SIDEWALL
1 FOAM BOARD
AP MINI MIRAGE - VERSION 1.1

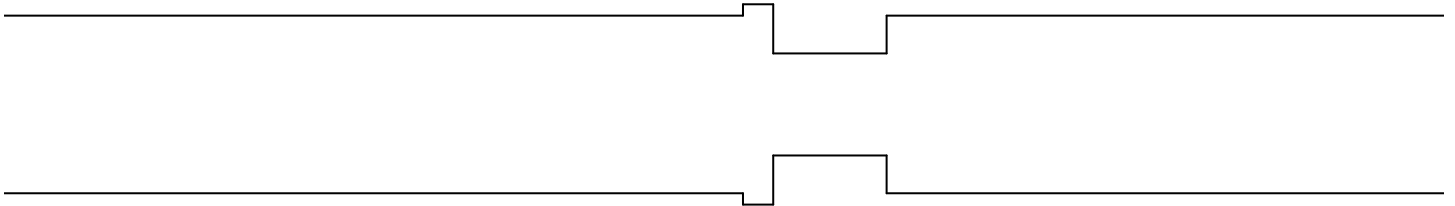

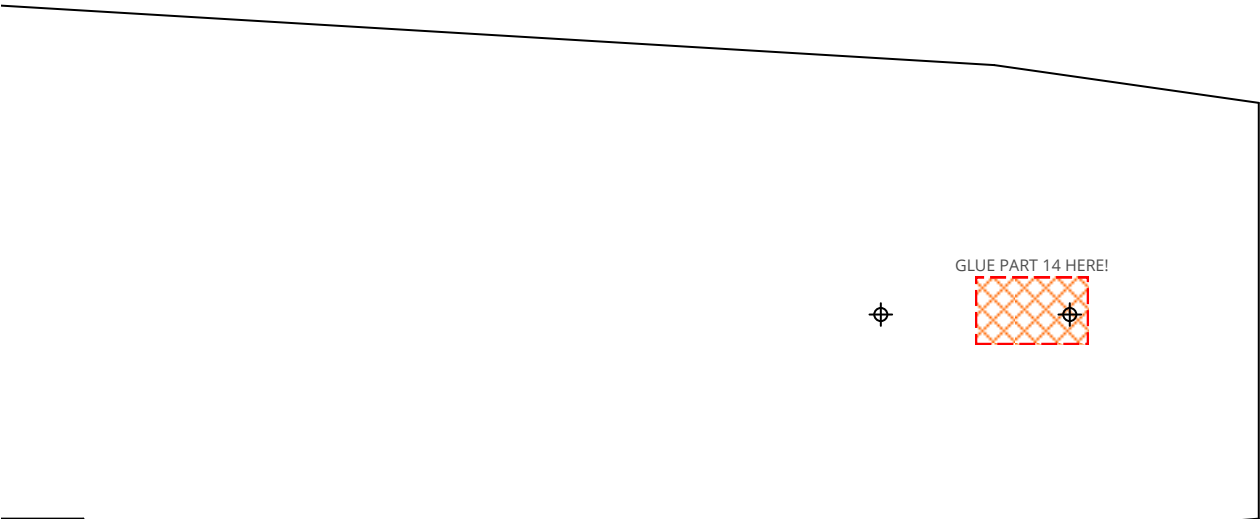

in 
cm 

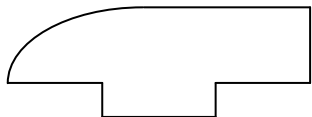

11 AIR INTAKE SCALE PART
2 FOAM BOARD
AP MINI MIRAGE - VERSION 1.1

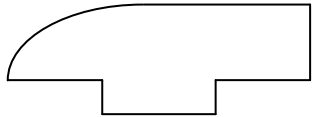

11 AIR INTAKE SCALE PART
2 FOAM BOARD
AP MINI MIRAGE - VERSION 1.1

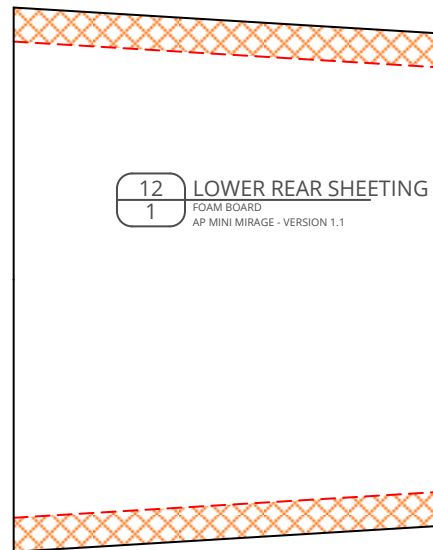

12 LOWER REAR SHEETING
1 FOAM BOARD
AP MINI MIRAGE - VERSION 1.1

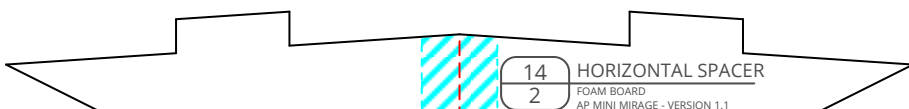

14 HORIZONTAL SPACER
2 FOAM BOARD
AP MINI MIRAGE - VERSION 1.1



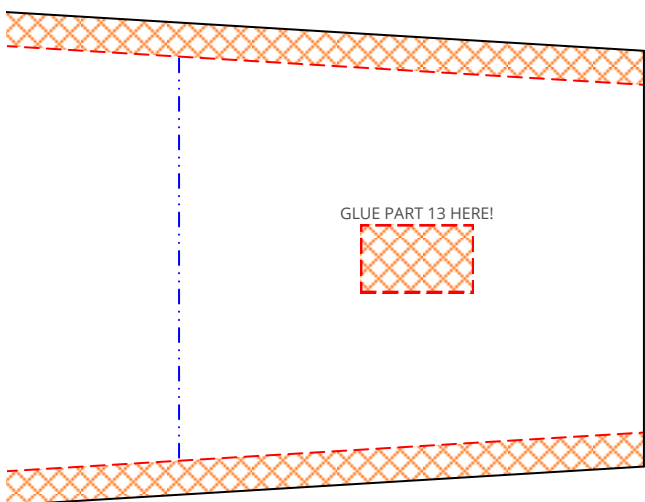

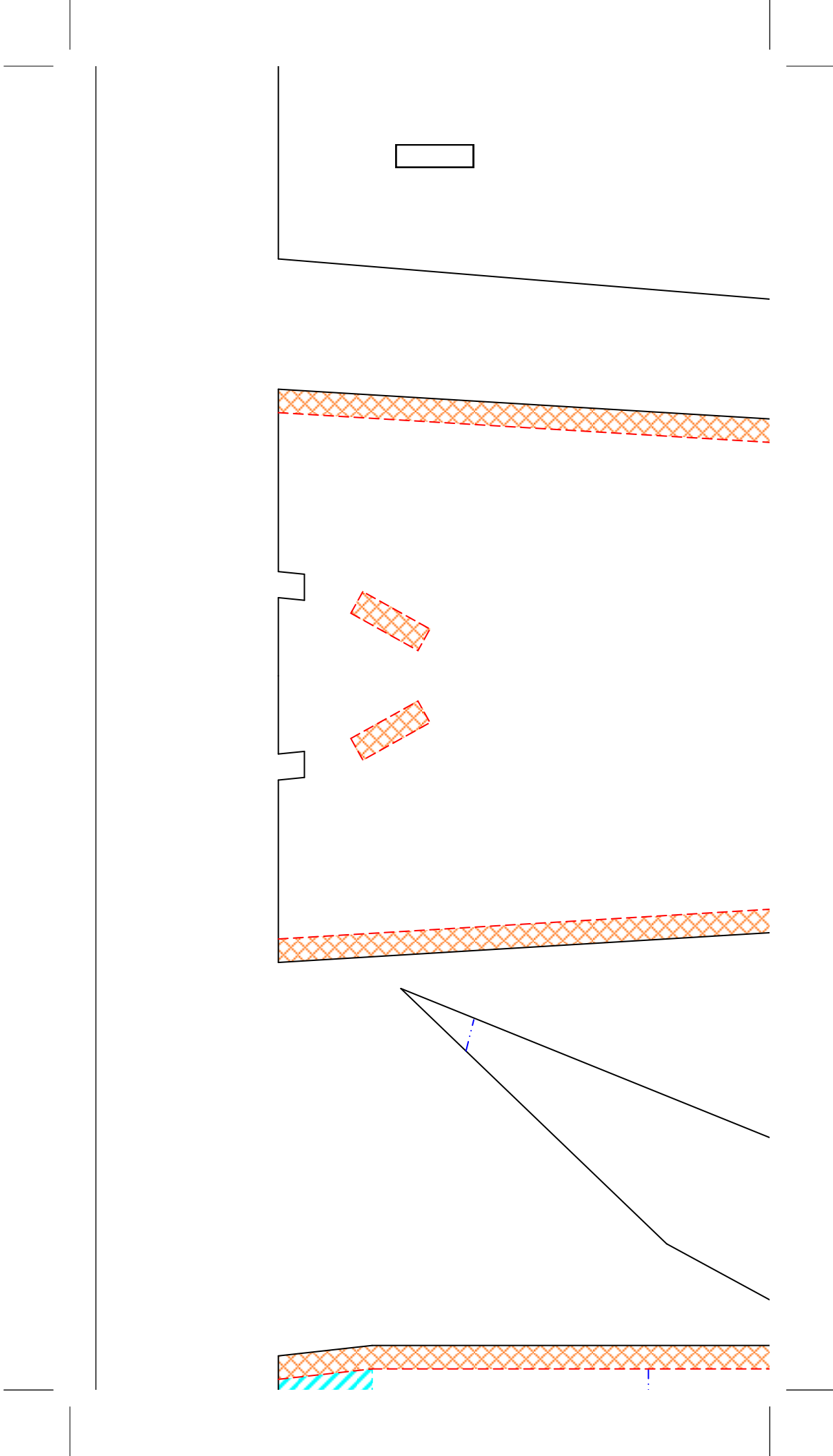

9 LEFT SIDEWALL
1 FOAM BOARD
AP MINI MIRAGE - VERSION 1.1

18 TOP SHEETING
1 FOAM BOARD
AP MINI MIRAGE - VERSION 1.1

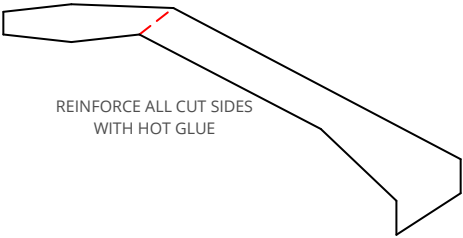

REINFORCE ALL CUT SIDES
WITH HOT GLUE

24 FUEL HOSE
1 FOAM BOARD
AP MINI MIRAGE - VERSION 1.1



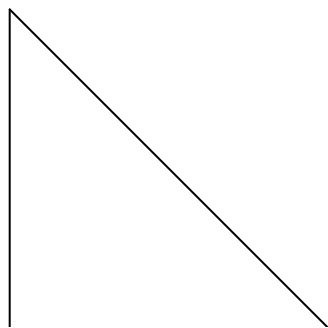
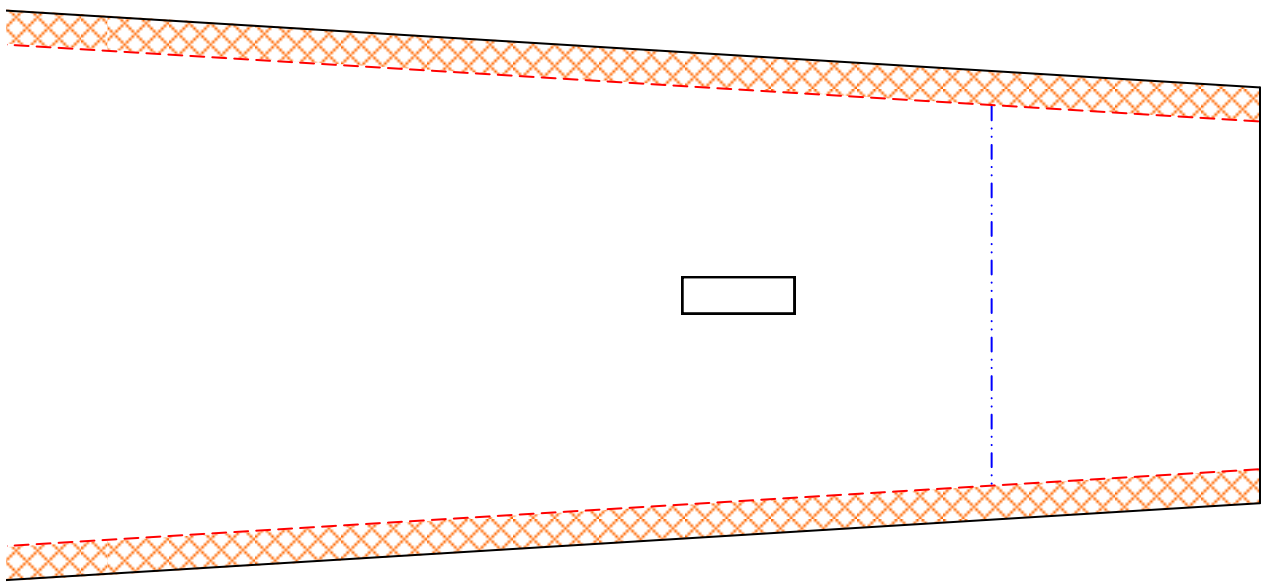

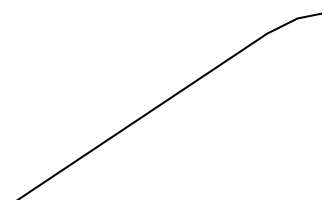
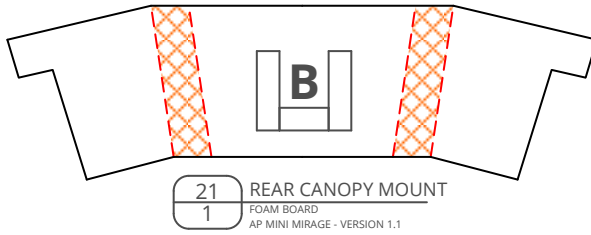
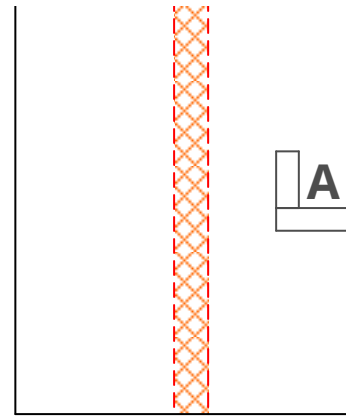
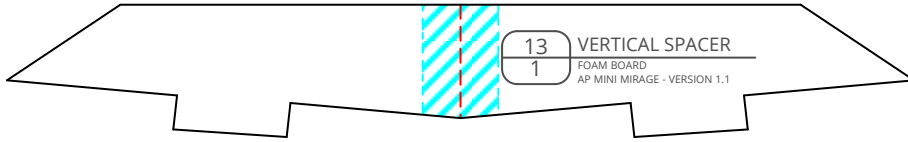
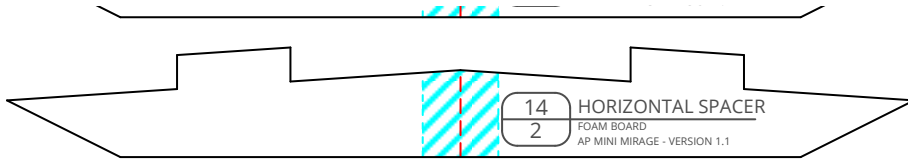



15 MINI POWER POD
FOAM BOARD
AP MINI MIRAGE - VERSION 1.1

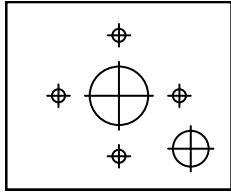

16 MINI FIREWALL
PLYWOOD
AP MINI MIRAGE - VERSION 1.1

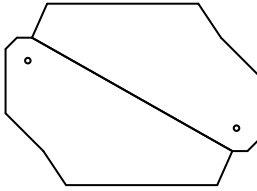

26 CONTROL HORN
PLASTIC CARD
AP MINI MIRAGE - VERSION 1.1

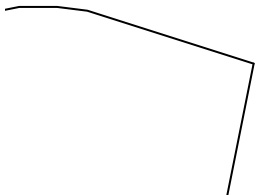

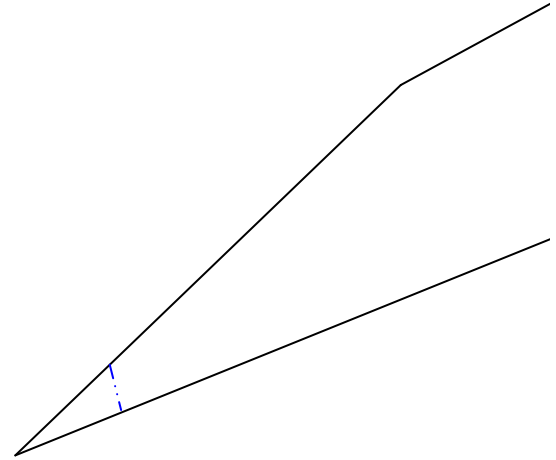
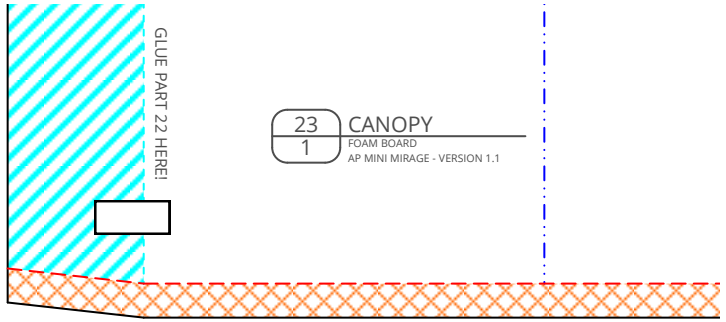

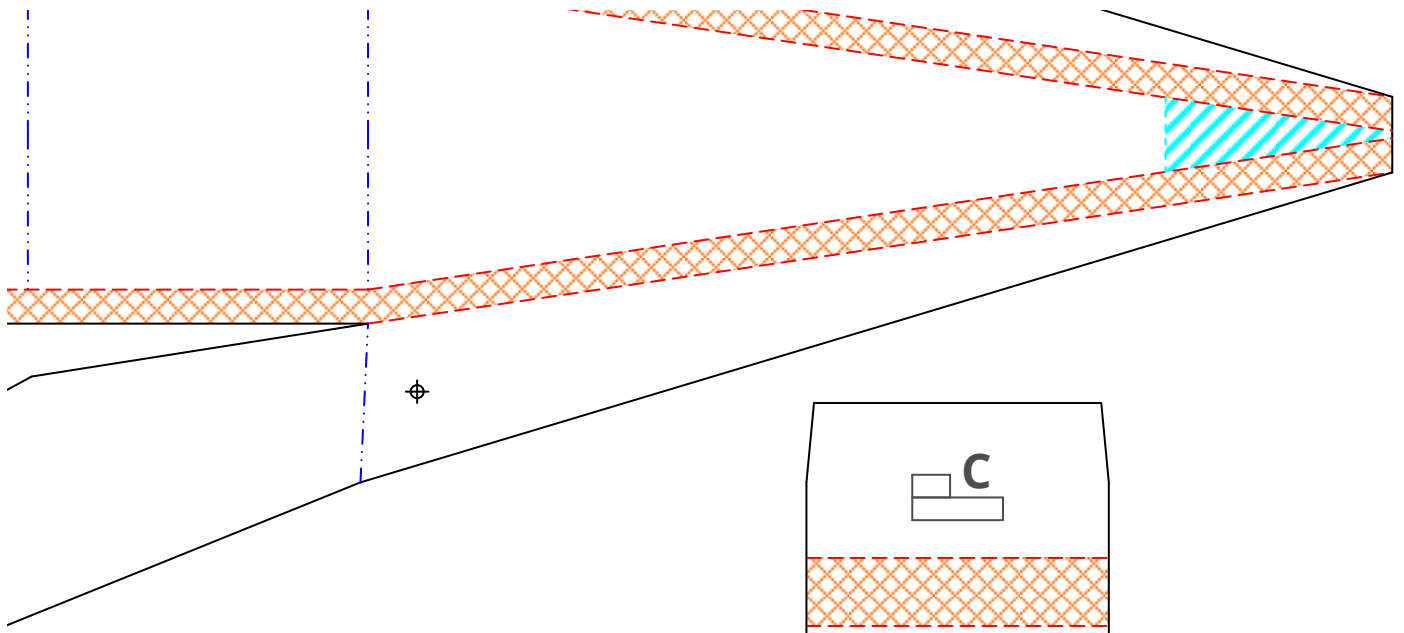

A callout box for the foam board material. It features a small diagram of a foam board with a 'C' label. Below the diagram is a red cross-hatch pattern. At the bottom, there is a table with the following information:

| | |
|----|------------------------------|
| 22 | FRONT CANOPY MOUNT |
| 1 | FOAM BOARD |
| | AP MINI MIRAGE - VERSION 1.1 |

G3 90° TRIANGLE
FOAM BOARD
1 AP MINI MIRAGE - VERSION 1.1

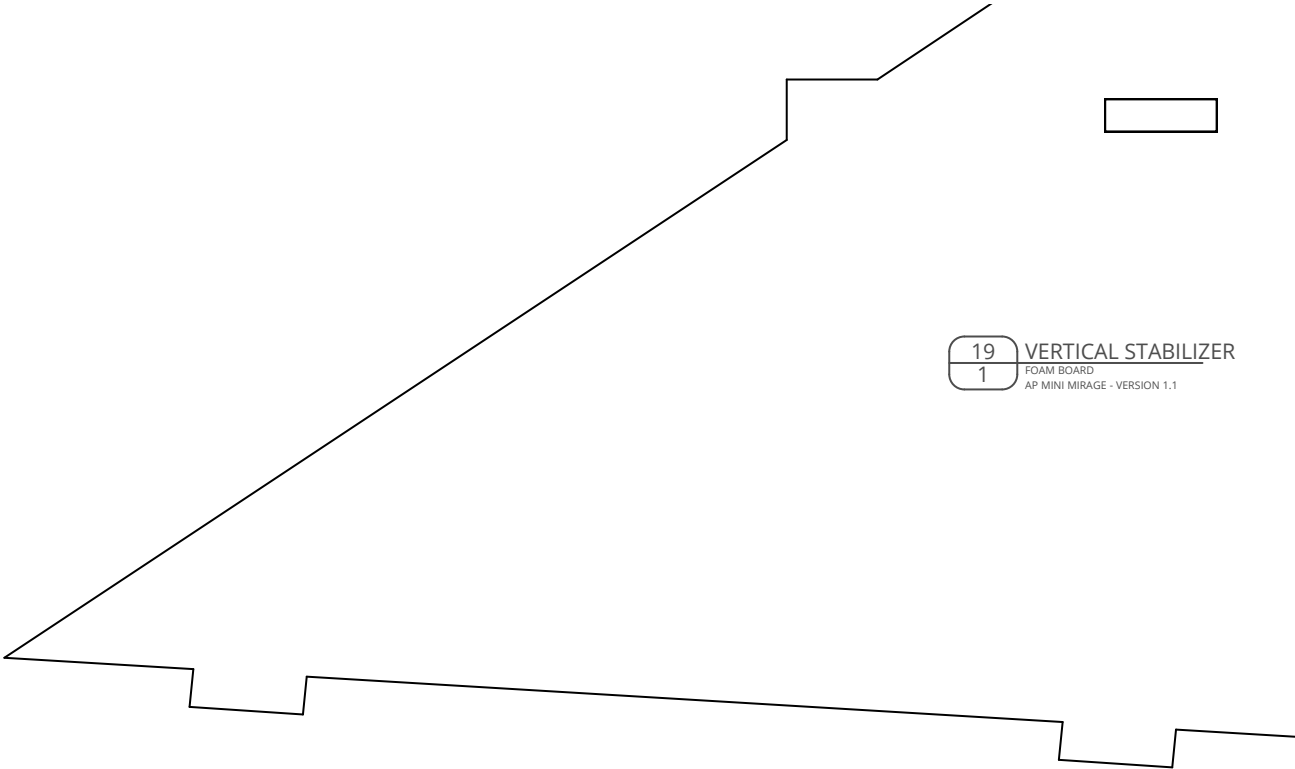

19 VERTICAL STABILIZER
1 FOAM BOARD
AP MINI MIRAGE - VERSION 1.1

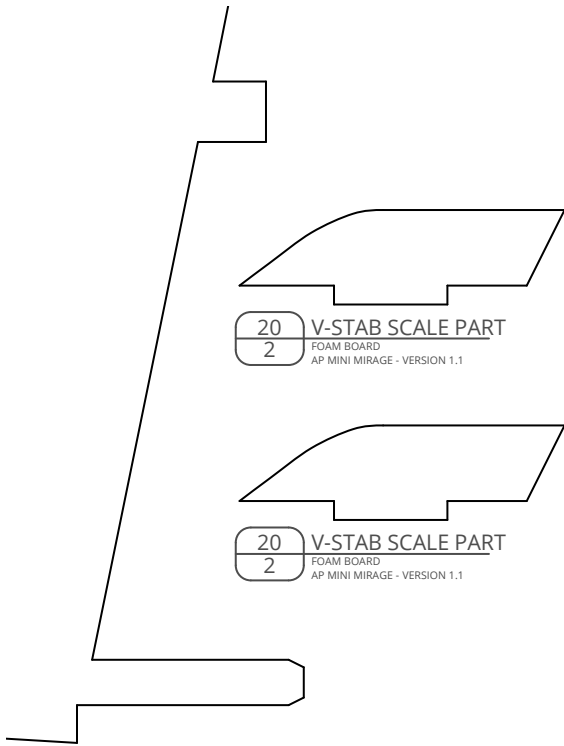

free of charge. Copies allowed for personal use only. Not for commercial use.

AP Mini Mirage

Design & Drawing by: Tony Roehling

OPTIONAL FUEL TANKS

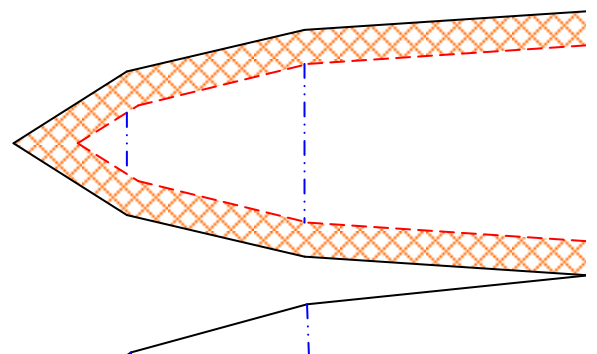
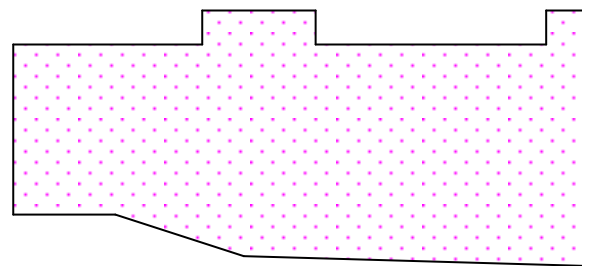

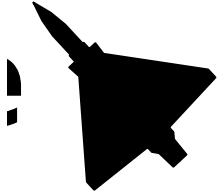

- VERSION 1.1 (2017-12-23)

5

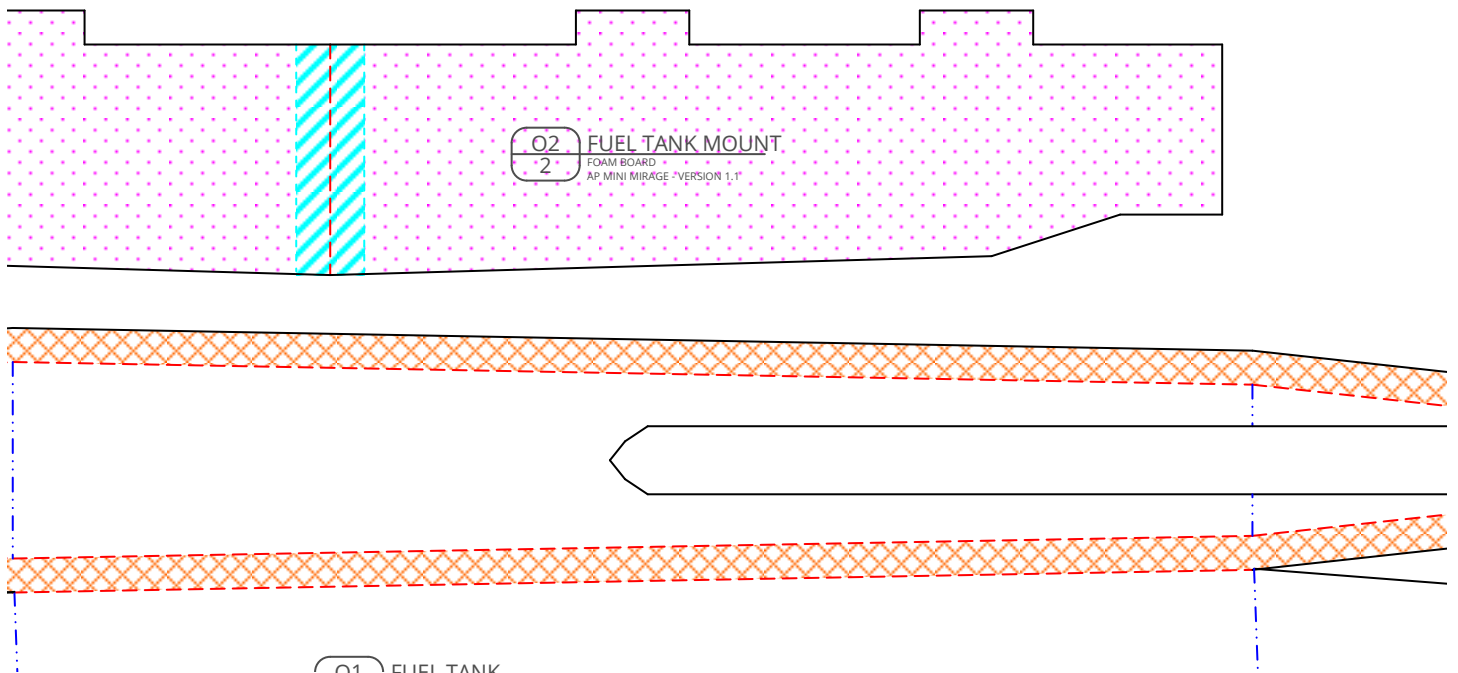

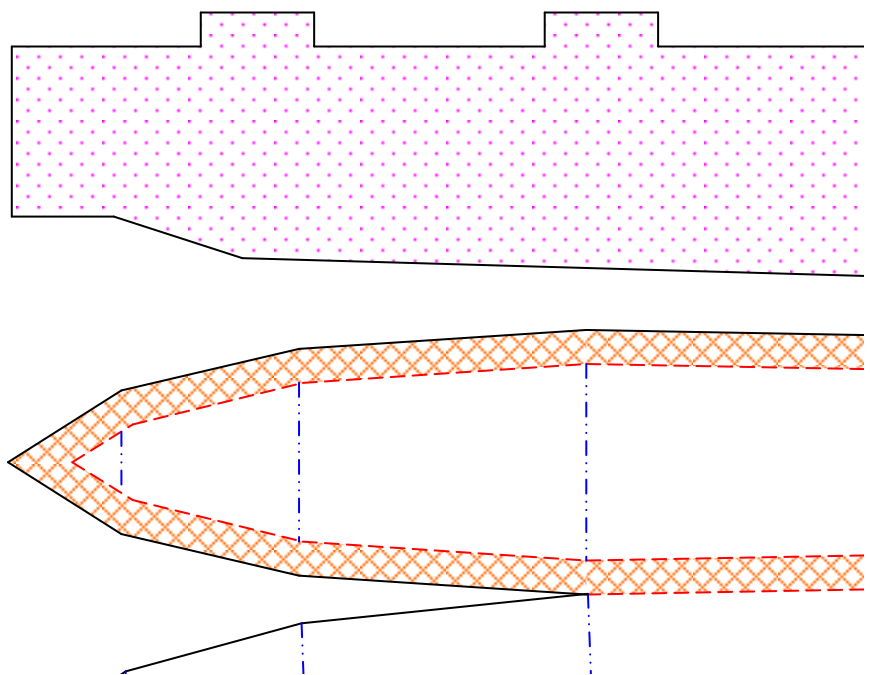
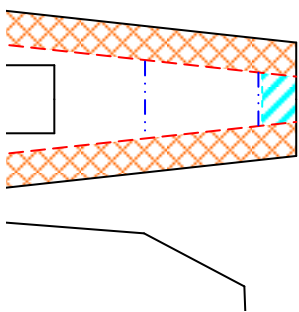

in 
cm 

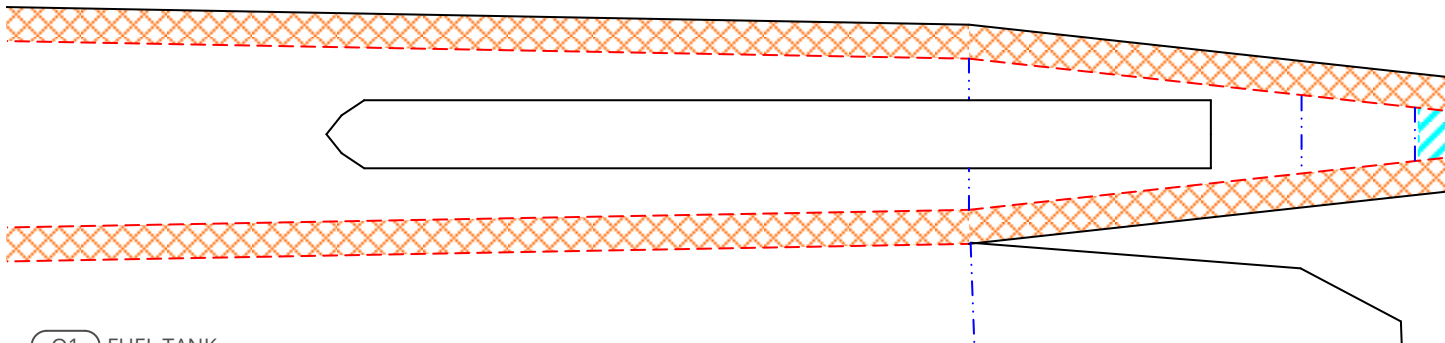



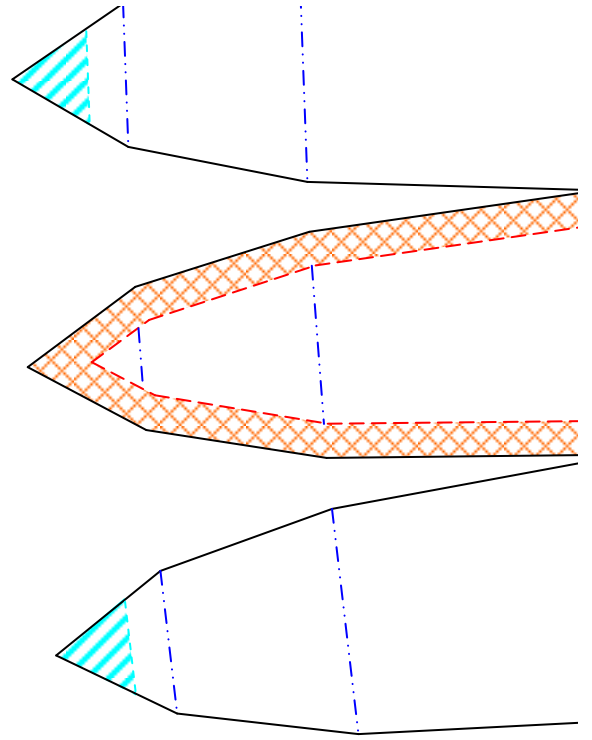

TEMPLATES FOR CUTTI

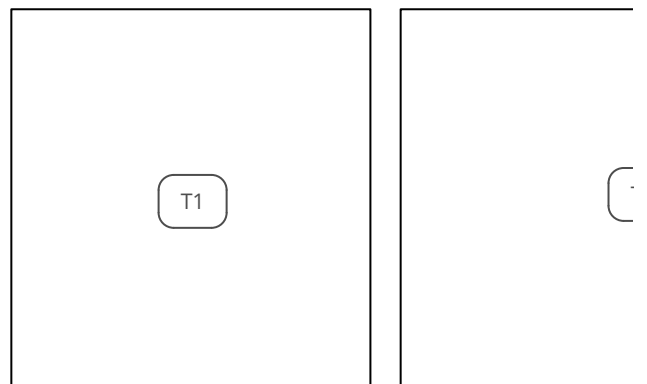
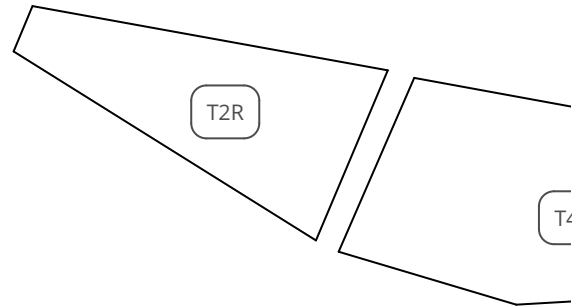

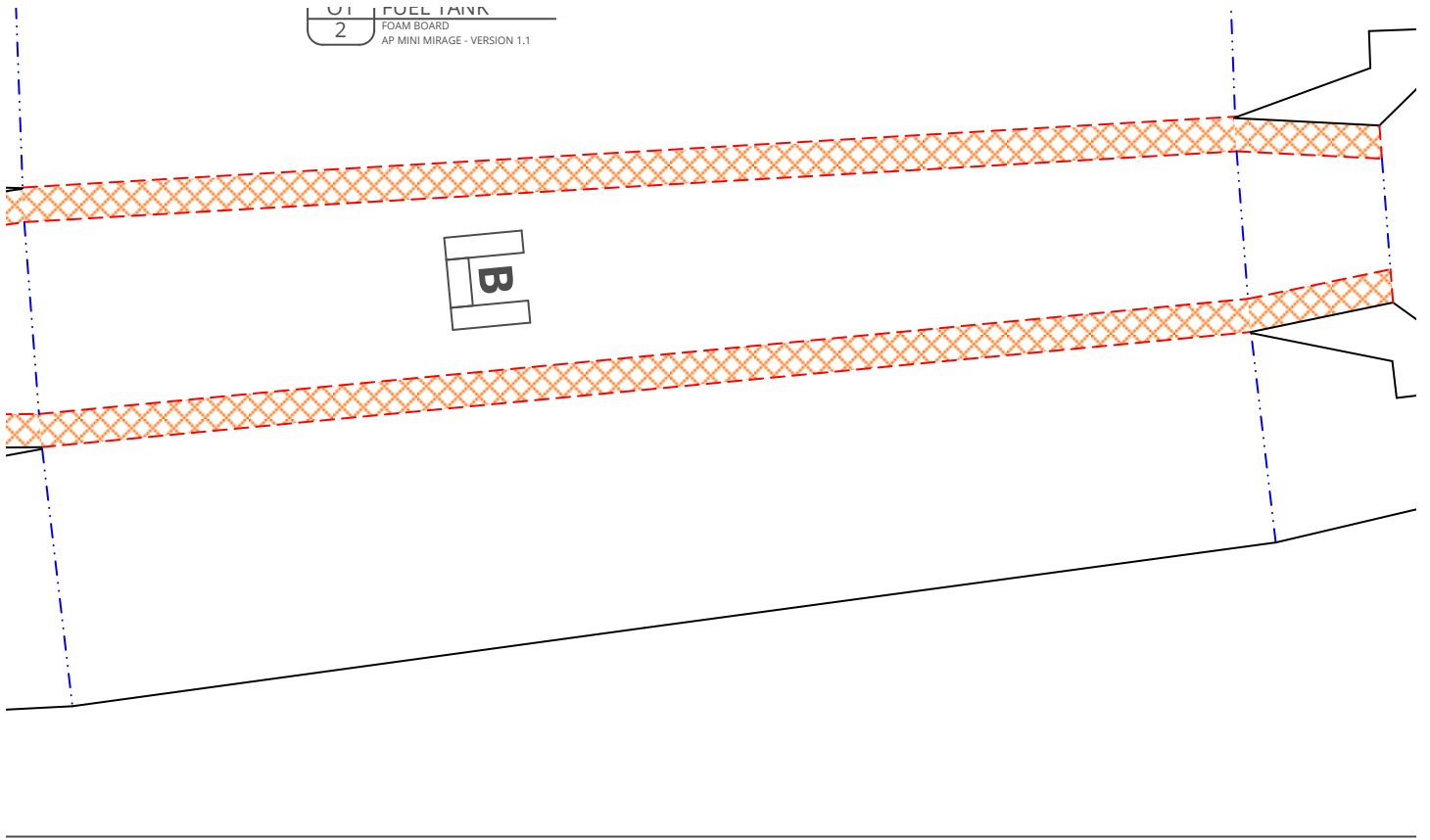

NG ADESIVE FILM

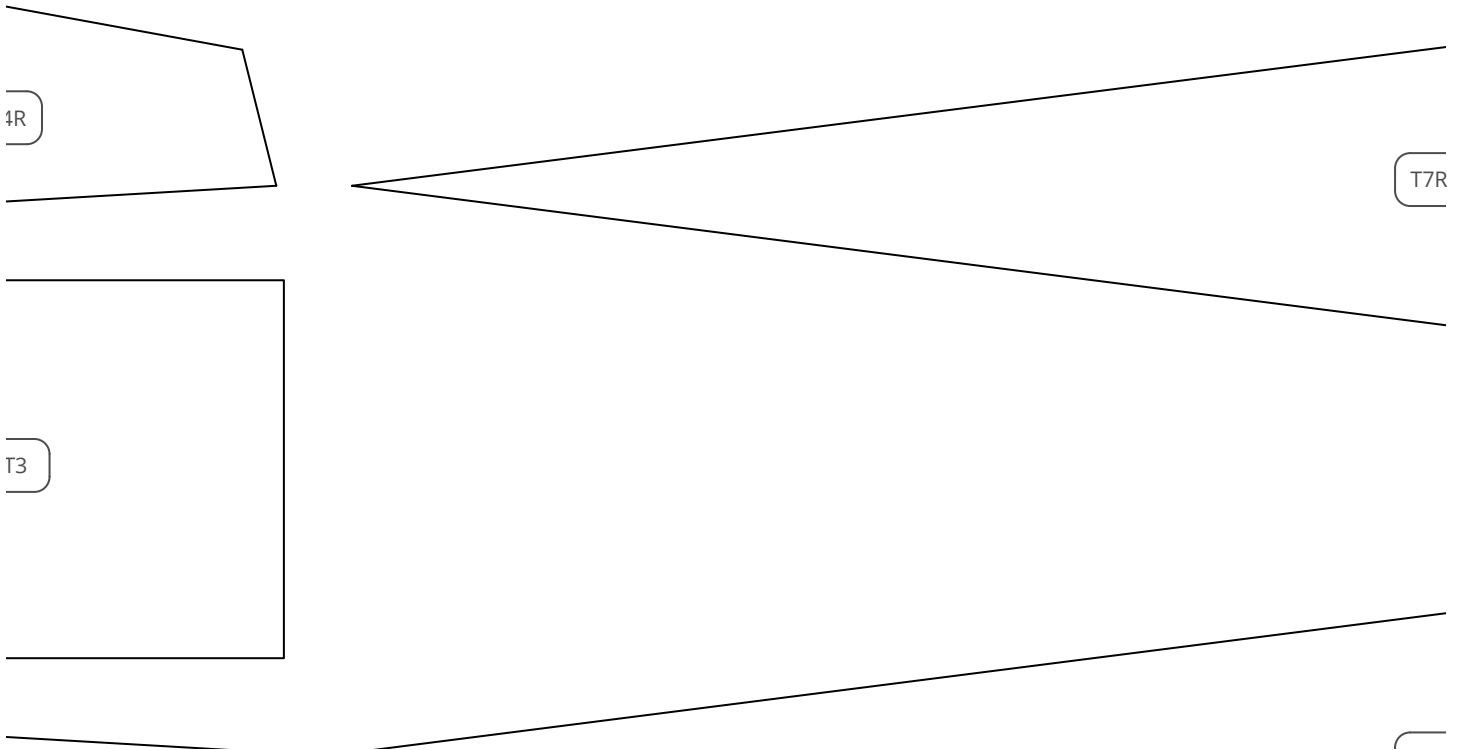

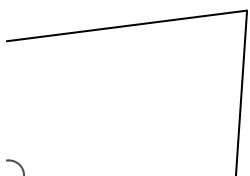
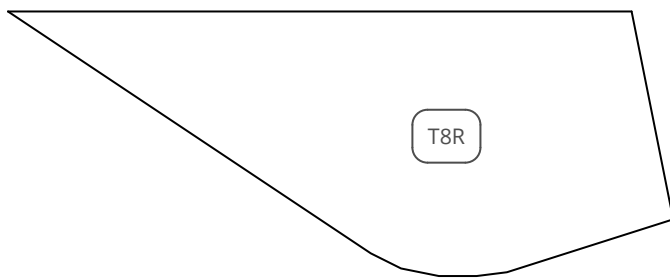
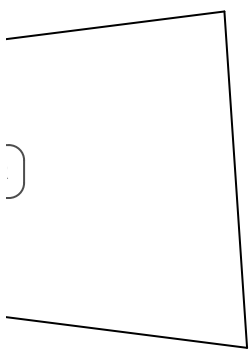
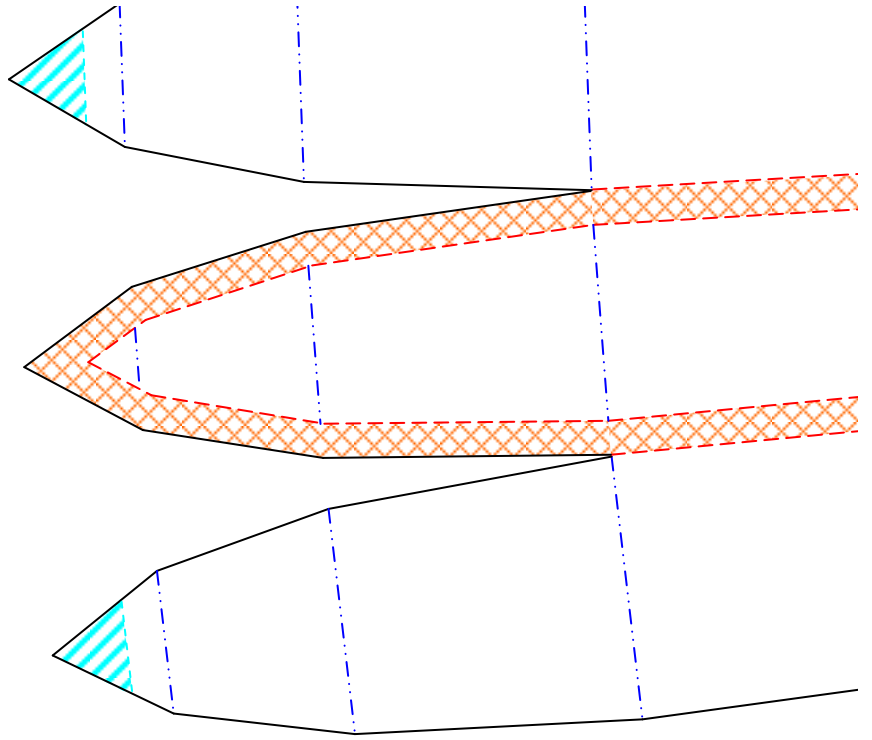
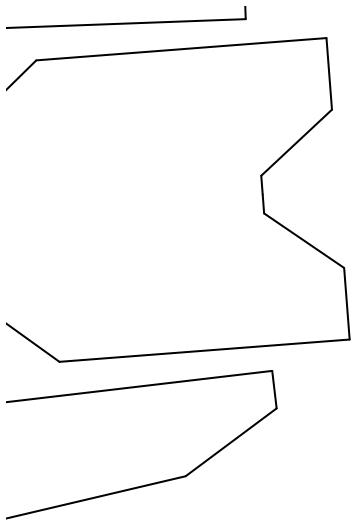

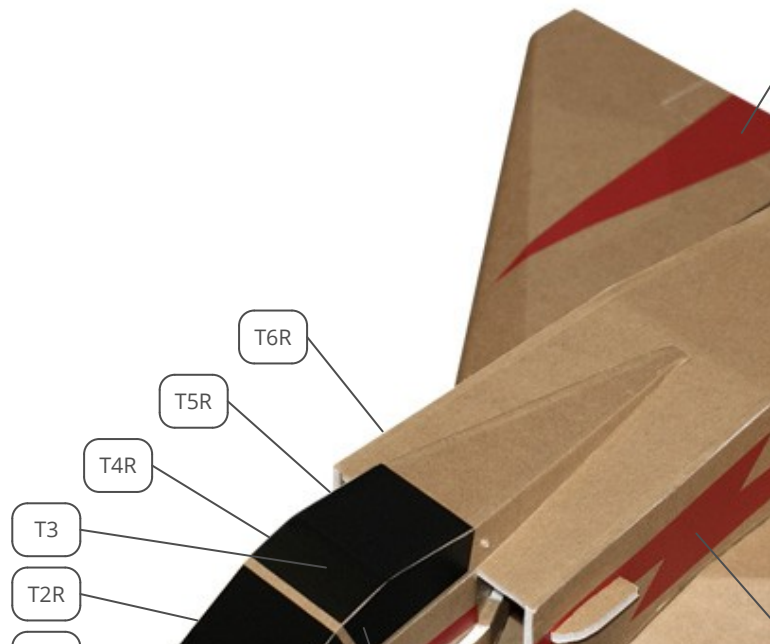
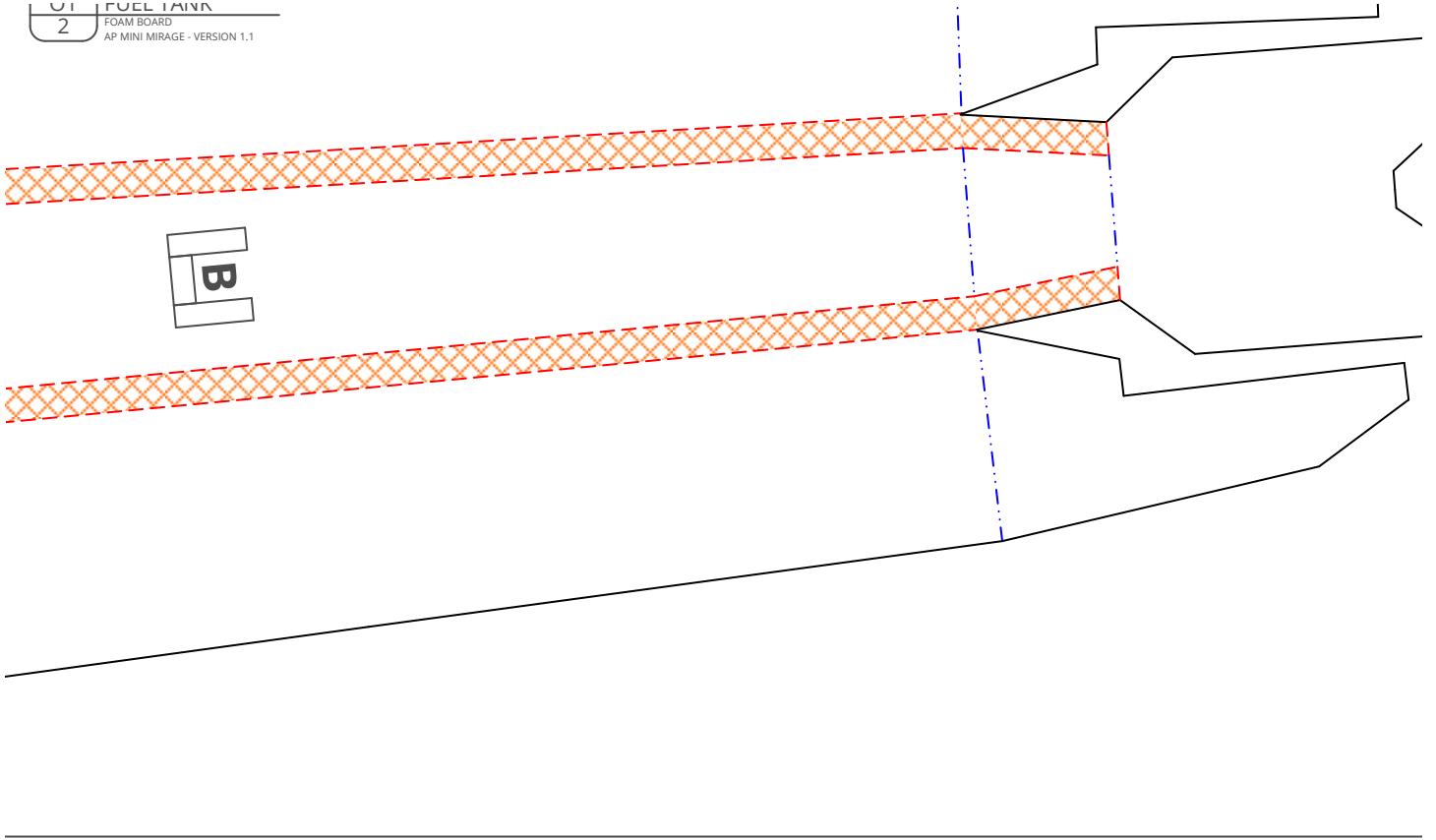

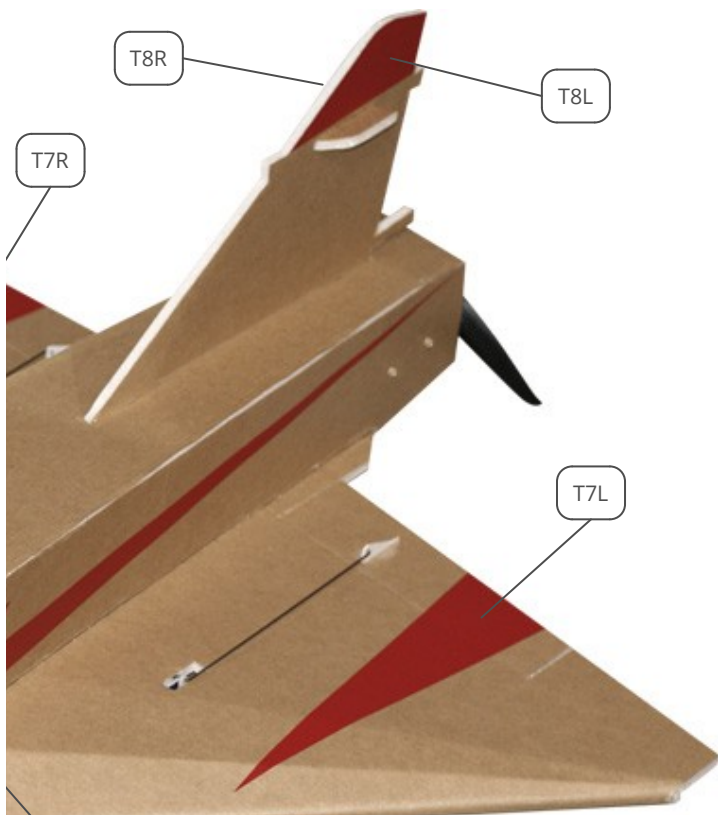

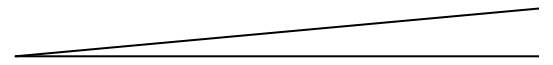
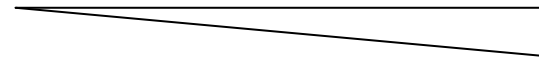
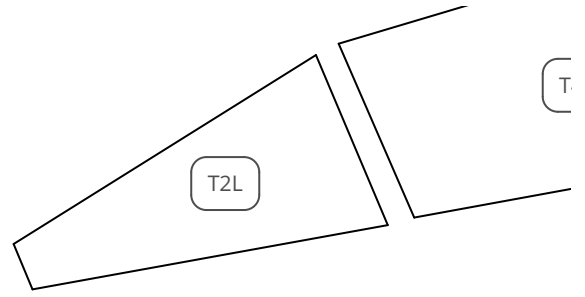

4L

T7L

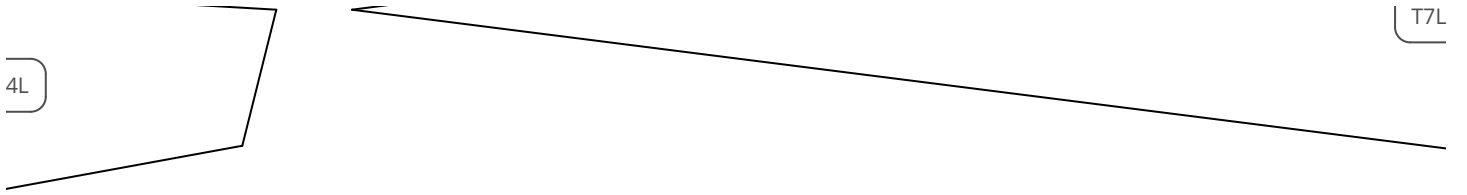

T5R

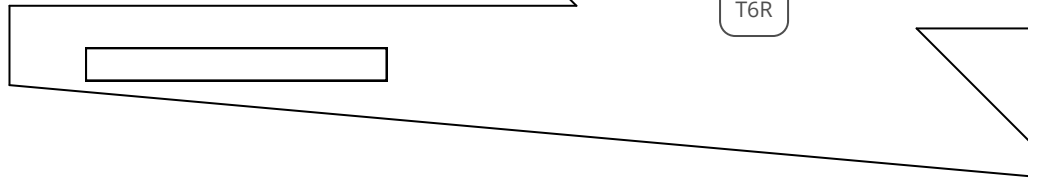

T6R



T5L

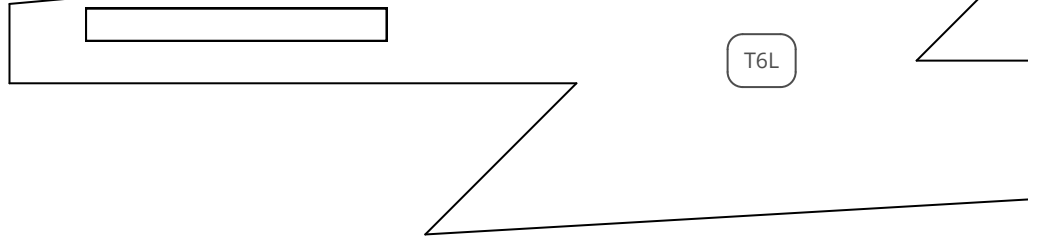

T6L

J

T&L

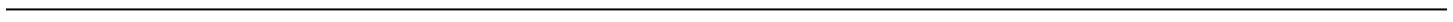
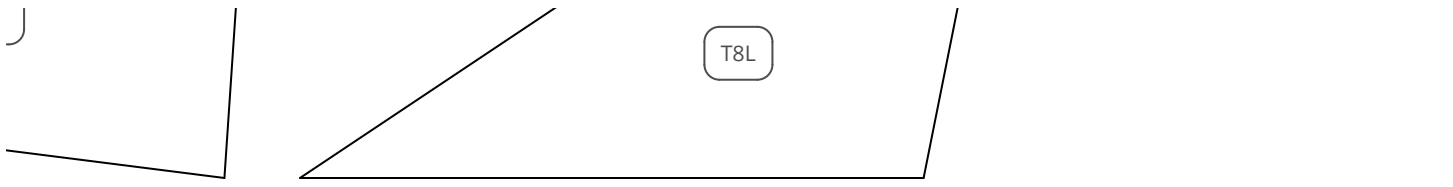

>

>

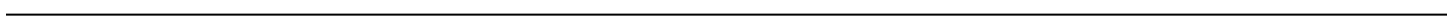

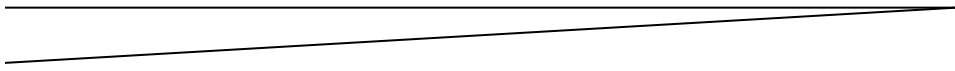
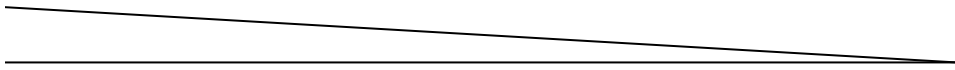
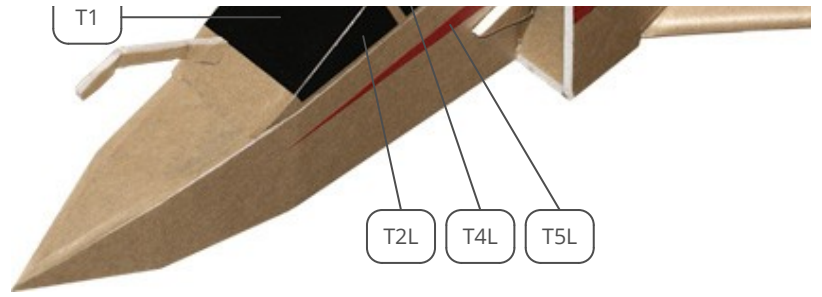



T6L

free of charge. Copies allowed for personal use only. Not for commercial use.