



airc-pirates.com

AP Mini Mirage

Version 1.1 (2017-12-23)

Design & Drawing by: Tony Roehling



SPECS

WINGSPAN: 520 mm | 20.47 in
CG: 124 mm | 4.88 in (from air intake)
LENGTH: 700 mm | 27.56 in
DRY WEIGHT: 205 g | 7.23 oz (without fuel tanks)
ALL UP WEIGHT: 275 g | 9.7 oz (with 3S 850 mAh | without fuel tanks)
EXPO: 30 %
CHANNELS: 3 (THR | AIL | ELV)

ELECTRONICS

MOTOR: 2300 kv (1806 or 2204)
PROPELLER: 5x5 or 6x4
ESC: 12 A
SERVOS: 2 x 5 g
BATTERY: 850 mAh 3S



DRAWING KEY

... is based on the Flite Test Drawing Key by Dan Sponholz

FOLD TYPES

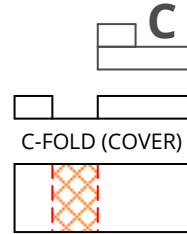
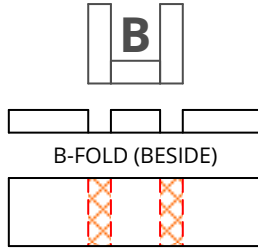
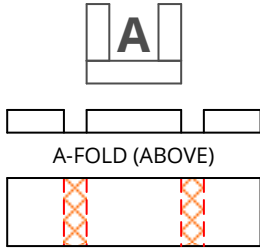

LINE TYPE/COLOR

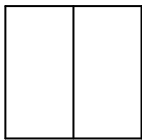

CUT

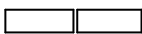

50% SCORE

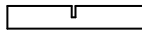

CREASE

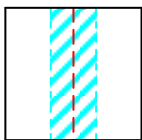
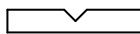

45° DOUBLE BEVEL

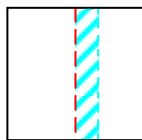

45° SINGLE BEVEL

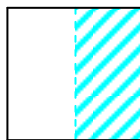
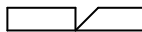

EDGE BEVEL

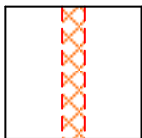
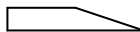

CAVITY

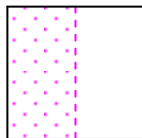

REMOVE PAPER

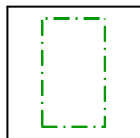

REFERENCE/
OPTIONAL



SYMBOLS

PART NUMBER



QUANTITY



DOWEL HOLE



CENTER OF GRAVITY (CG)

AP Mini Mirage - PARTS LIST

Version 1.1 (2017-12-23)

PART NR.	DESCRIPTION	QUANTITY	MATERIAL	SHEET
1	LEFT WING	1	FOAM BOARD	1
2	RIGHT WING	1	FOAM BOARD	1
3	FRONT SPAR	2	FOAM BOARD	1
4	REAR SPAR	2	FOAM BOARD	1
5	NOSE	1	FOAM BOARD	1
6	NOSE SHEETING	1	FOAM BOARD	1
7	LEFT AIR INTAKE CONE	1	FOAM BOARD	1
8	RIGHT AIR INTAKE CONE	1	FOAM BOARD	1
9	LEFT SIDEWALL	1	FOAM BOARD	2
10	RIGHT SIDEWALL	1	FOAM BOARD	2
11	AIR INTAKE SCALE PART	2	FOAM BOARD	2
12	LOWER REAR SHEETING	1	PLASTIC CARD	2
13	VERTICAL SPACER	1	FOAM BOARD	2
14	HORIZONTAL SPACER	2	FOAM BOARD	2
15	MINI POWER POD	1	FOAM BOARD	2
16	MINI FIREWALL	1	PLYWOOD max. 5mm	2
17	POWER POD MOUNT PIN	2	BBQ SKEWER	2
18	TOP SHEETING	1	FOAM BOARD	2
19	VERTICAL STABILIZER	1	FOAM BOARD	2
20	V-STAB SCALE PART	2	FOAM BOARD	2
21	REAR CANOPY MOUNT	1	FOAM BOARD	2
22	FRONT CANOPY MOUNT	1	FOAM BOARD	2
23	CANOPY	1	FOAM BOARD	2
24	FUEL HOSE	1	FOAM BOARD	2
25	CANOPY MOUNT PIN	1	BBQ SKEWER	2
26	CONTROL HORN	2	PLASTIC CARD	2
G1	ELEVON NEUTRAL GAUGE	1	FOAM BOARD	1
G2	THROW GAUGE	1	FOAM BOARD	1
G3	90° TRIANGLE	1	FOAM BOARD	2
O1	FUEL TANK	2	FOAM BOARD	3
O2	FUEL TANK MOUNT	2	FOAM BOARD	3
T1-T8	TEMPLATES FOR CUTTING ADESIVE FILM			3
	OTHER MATERIALS			
	STEEL WIRE (Ø 1mm) FOR THE LINKAGE RODS			
	VELCRO TO MOUNT THE BATTERY, ESC, ...			

Build the Mini Mirage in the order of the part numbers!

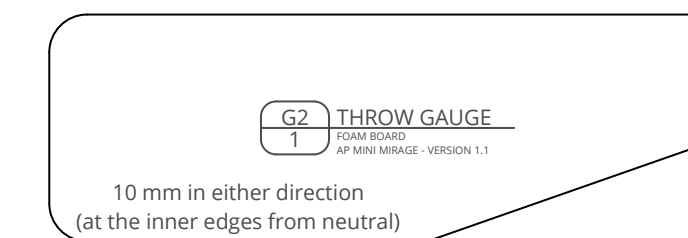
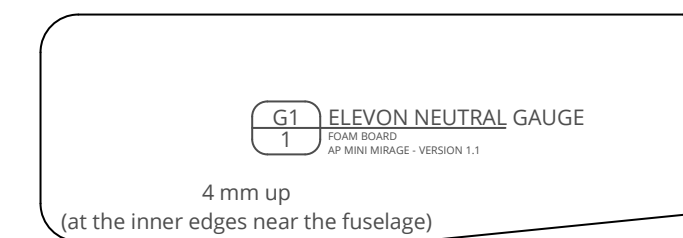
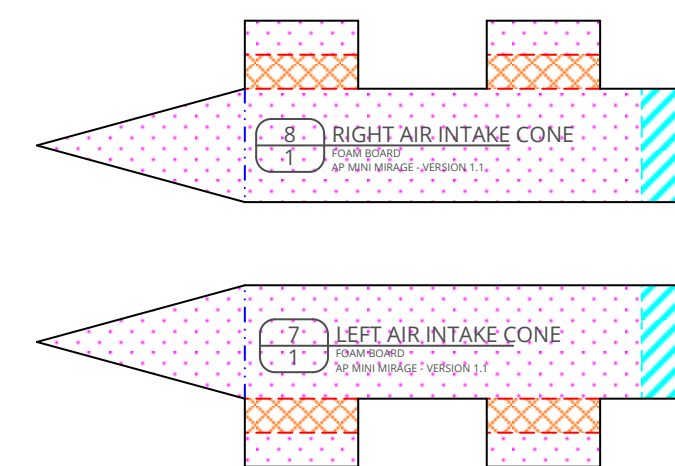
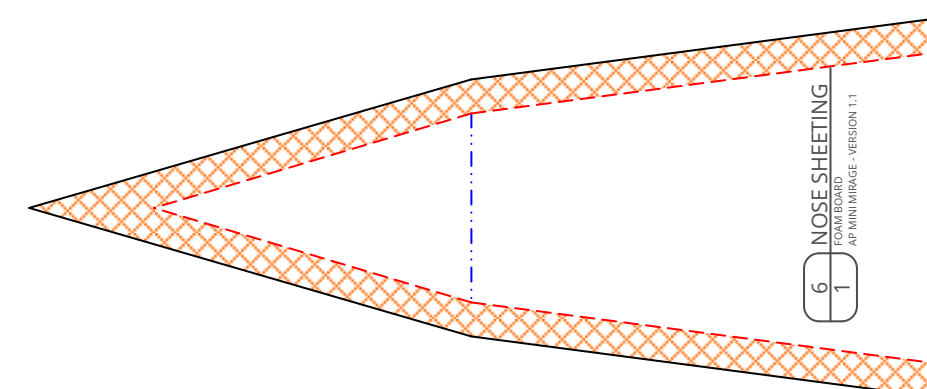
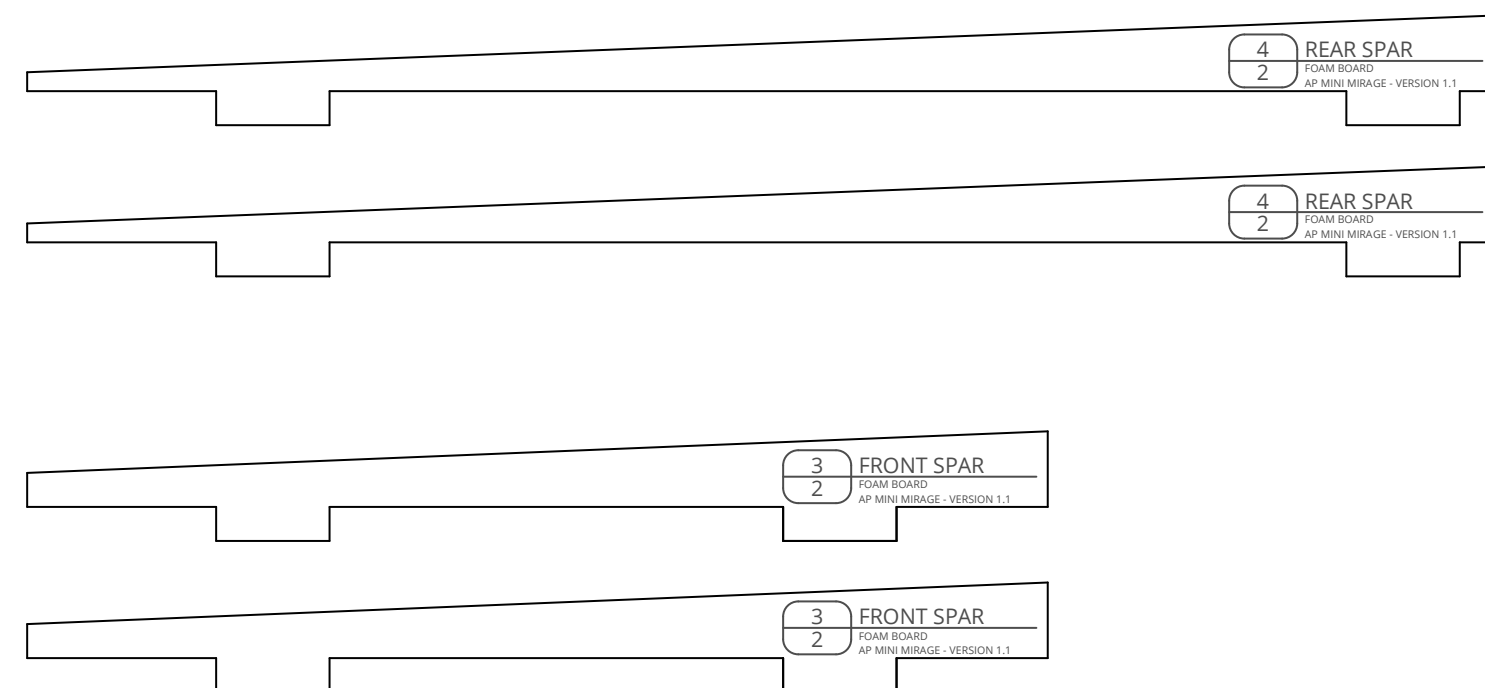
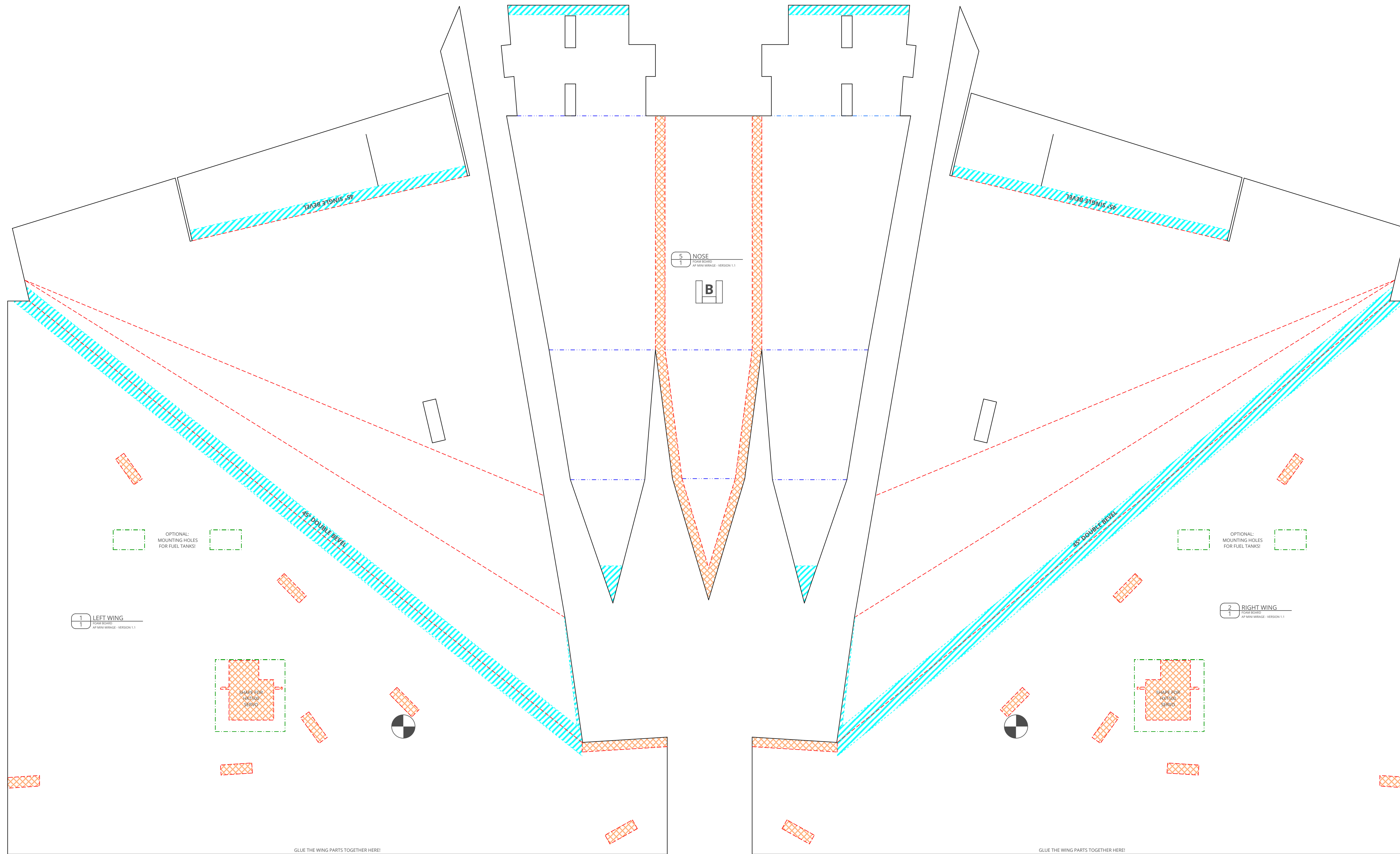
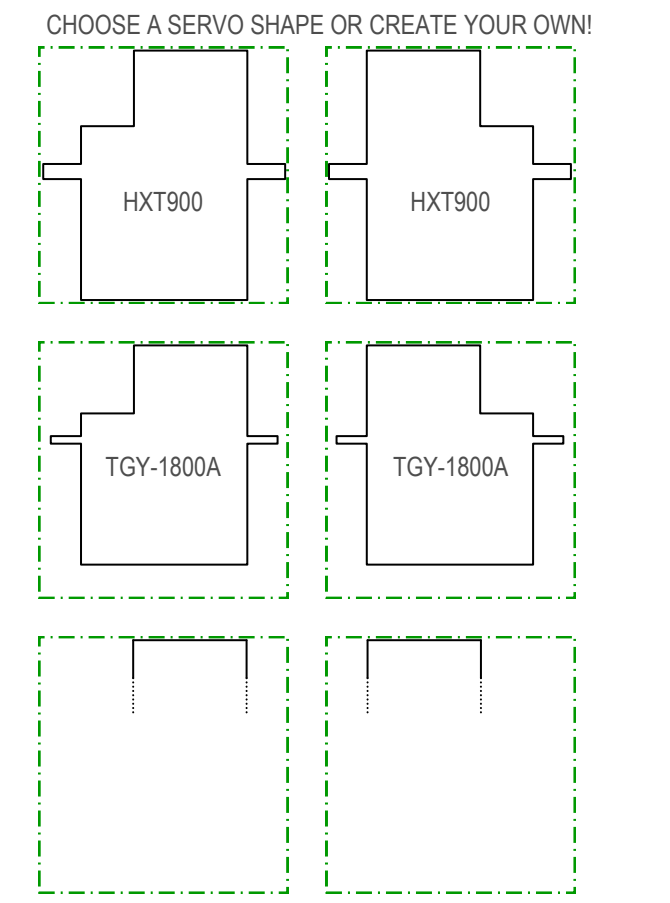
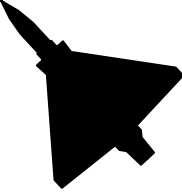

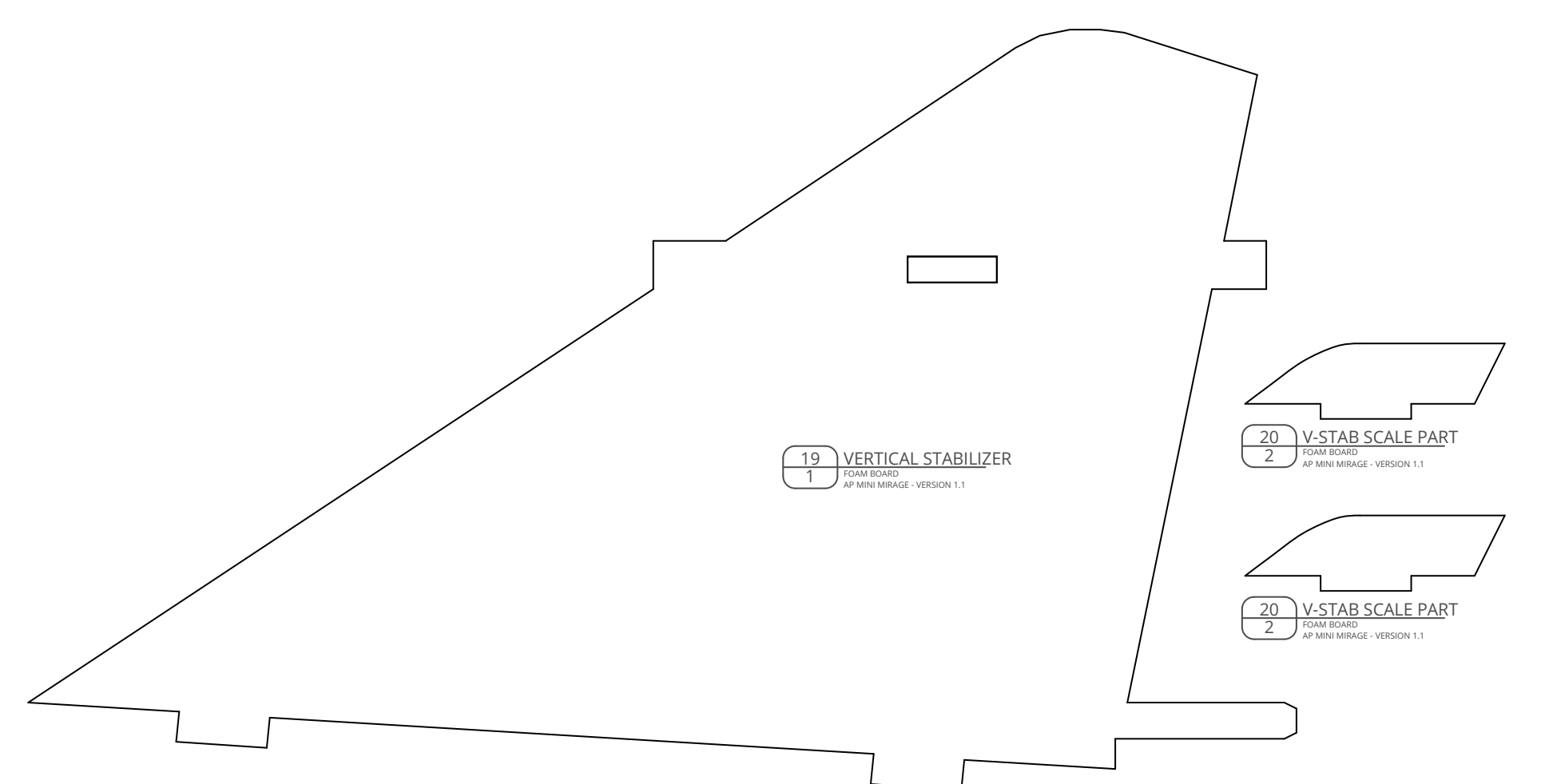
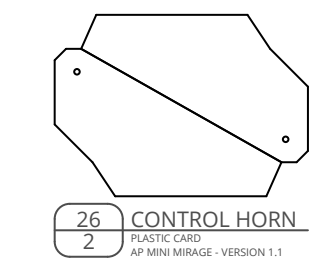
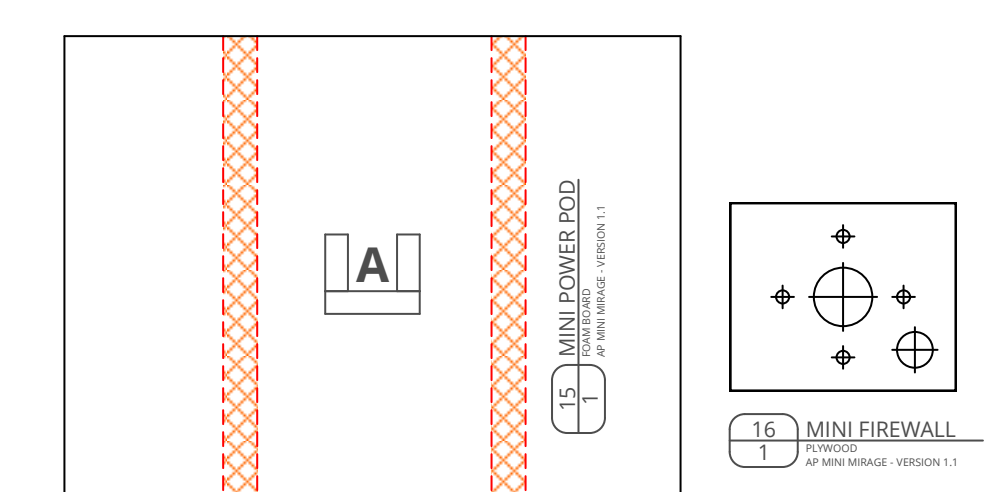
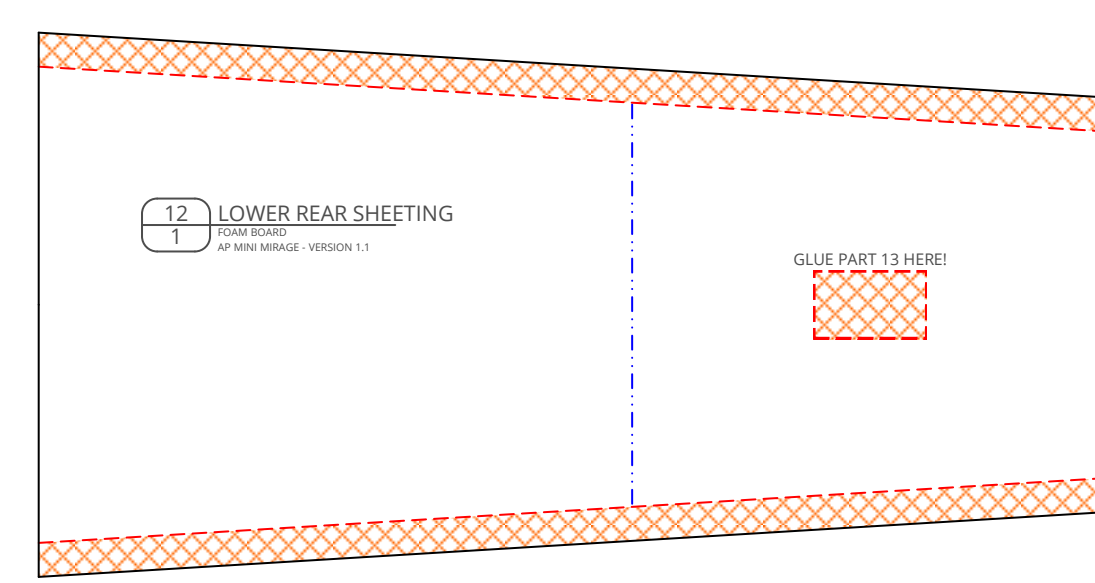
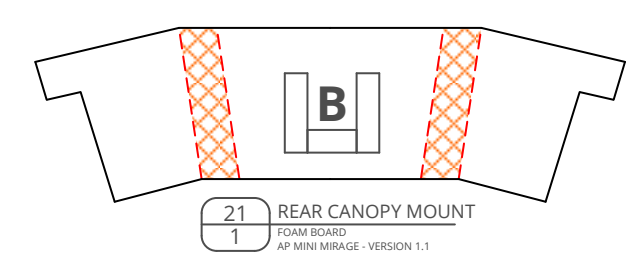
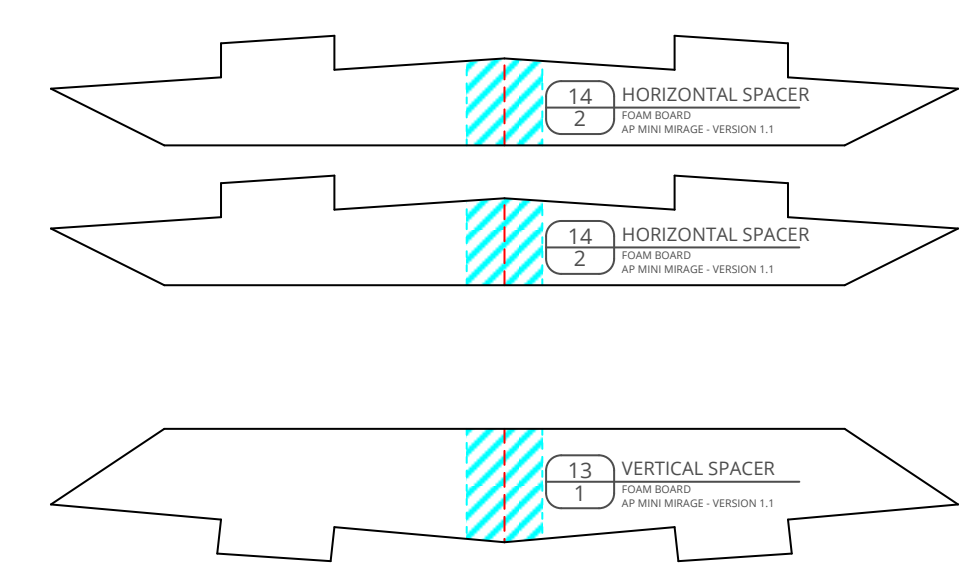
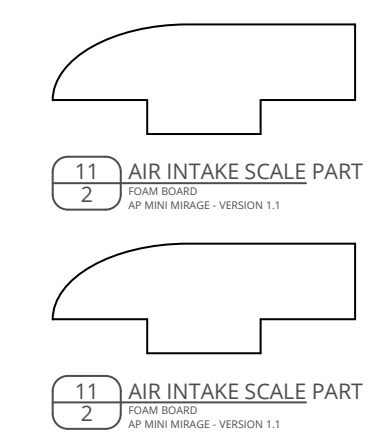
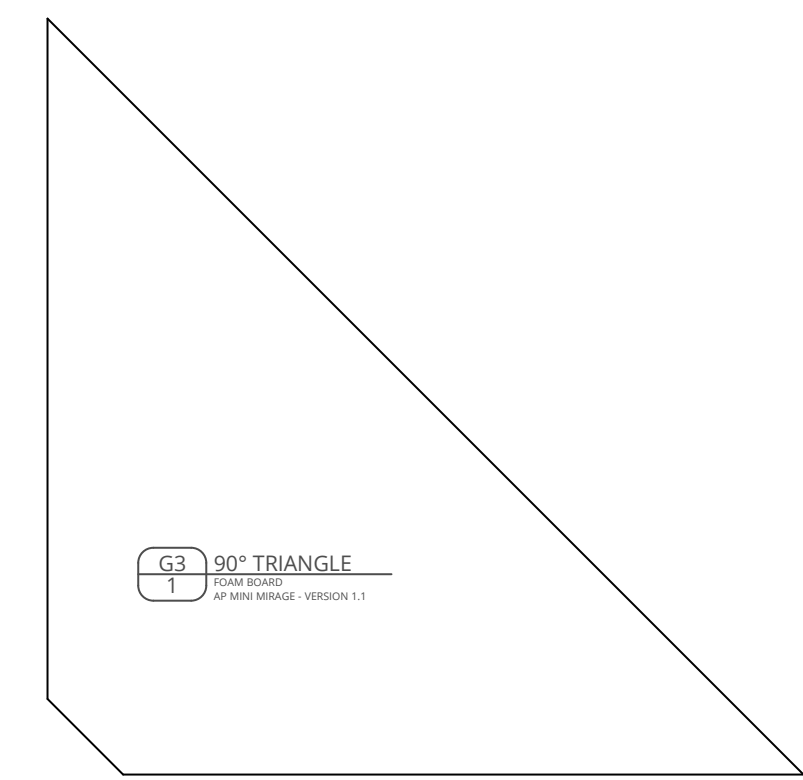
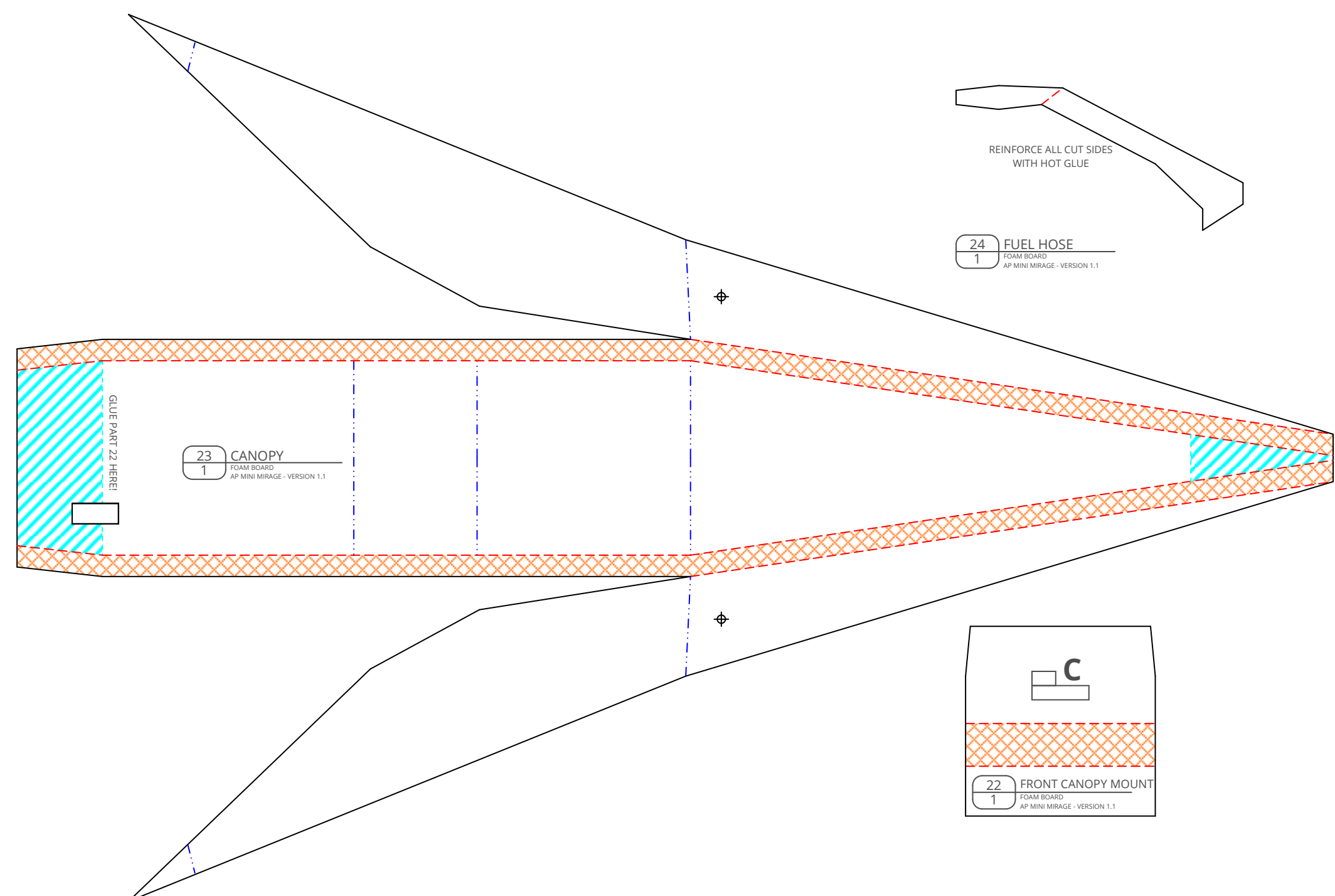
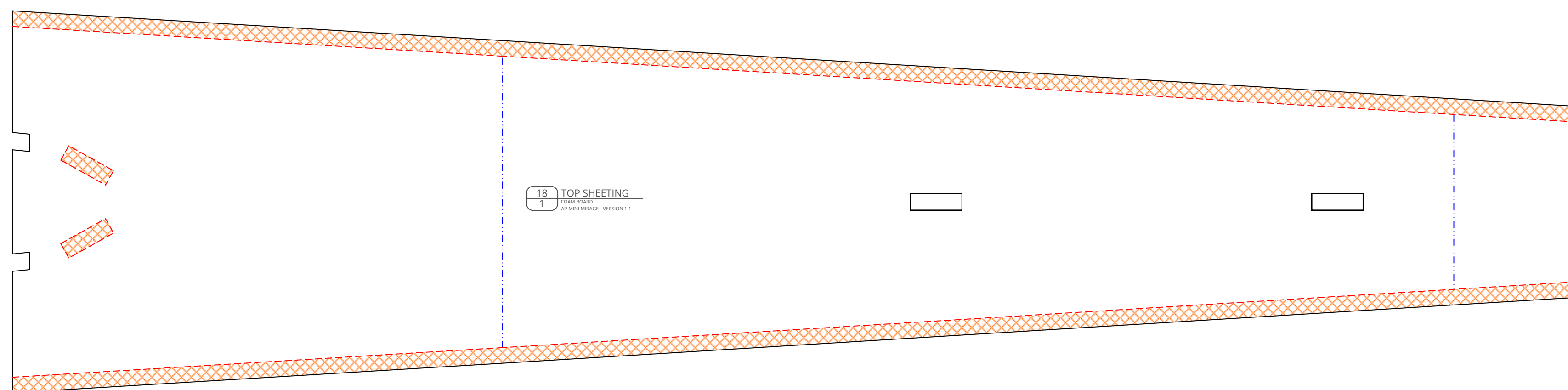
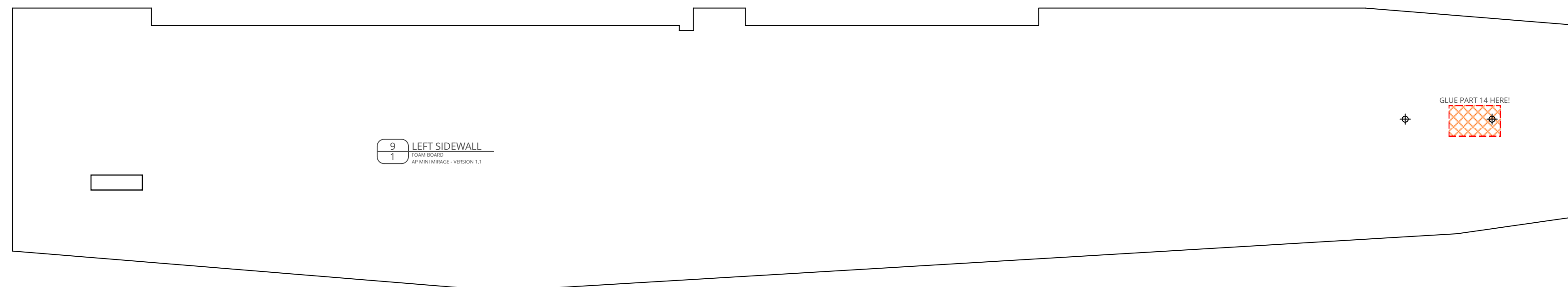
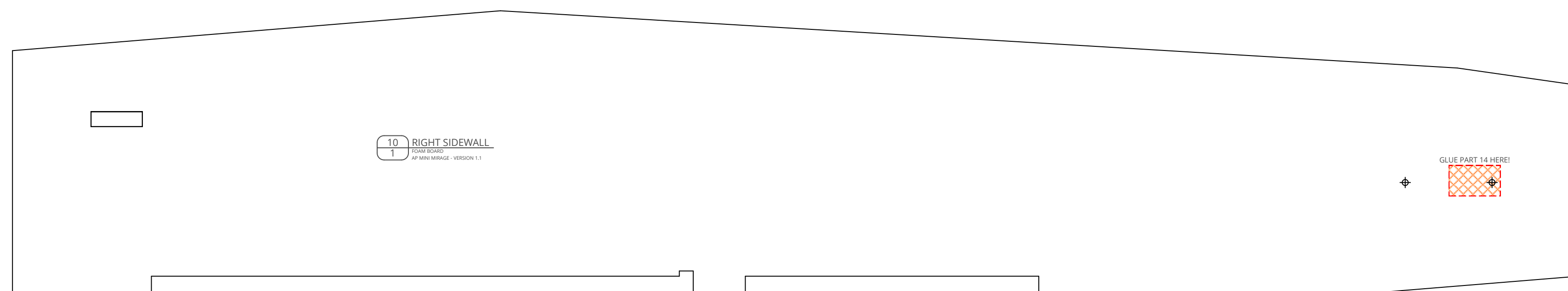

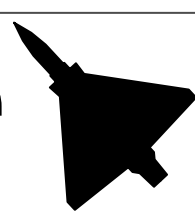

OPTIONAL FUEL TANKS

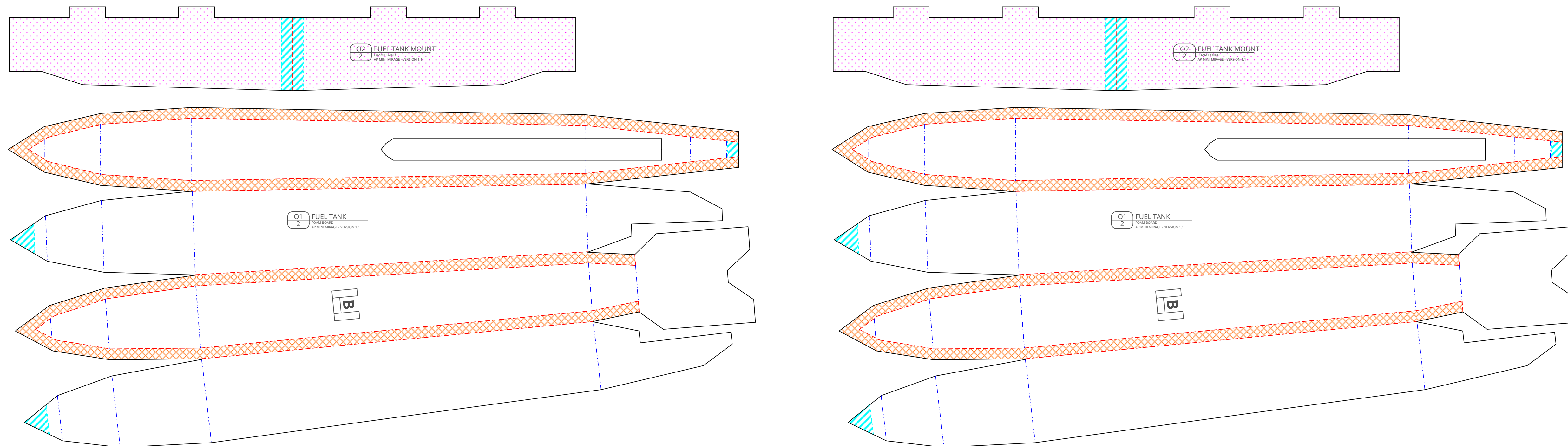

TEMPLATES FOR CUTTING ADESIVE FILM

