

AP Godai - SECTION

Design & Drawing by: Tony Roehling

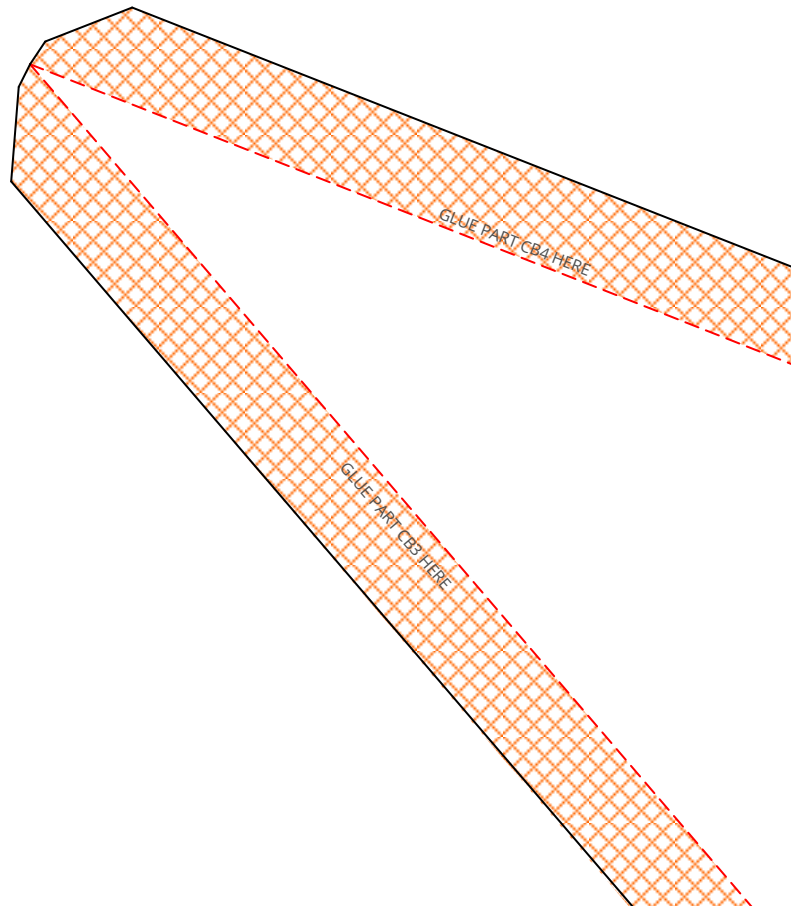

N CB - UNDERCARRIAGE WITH

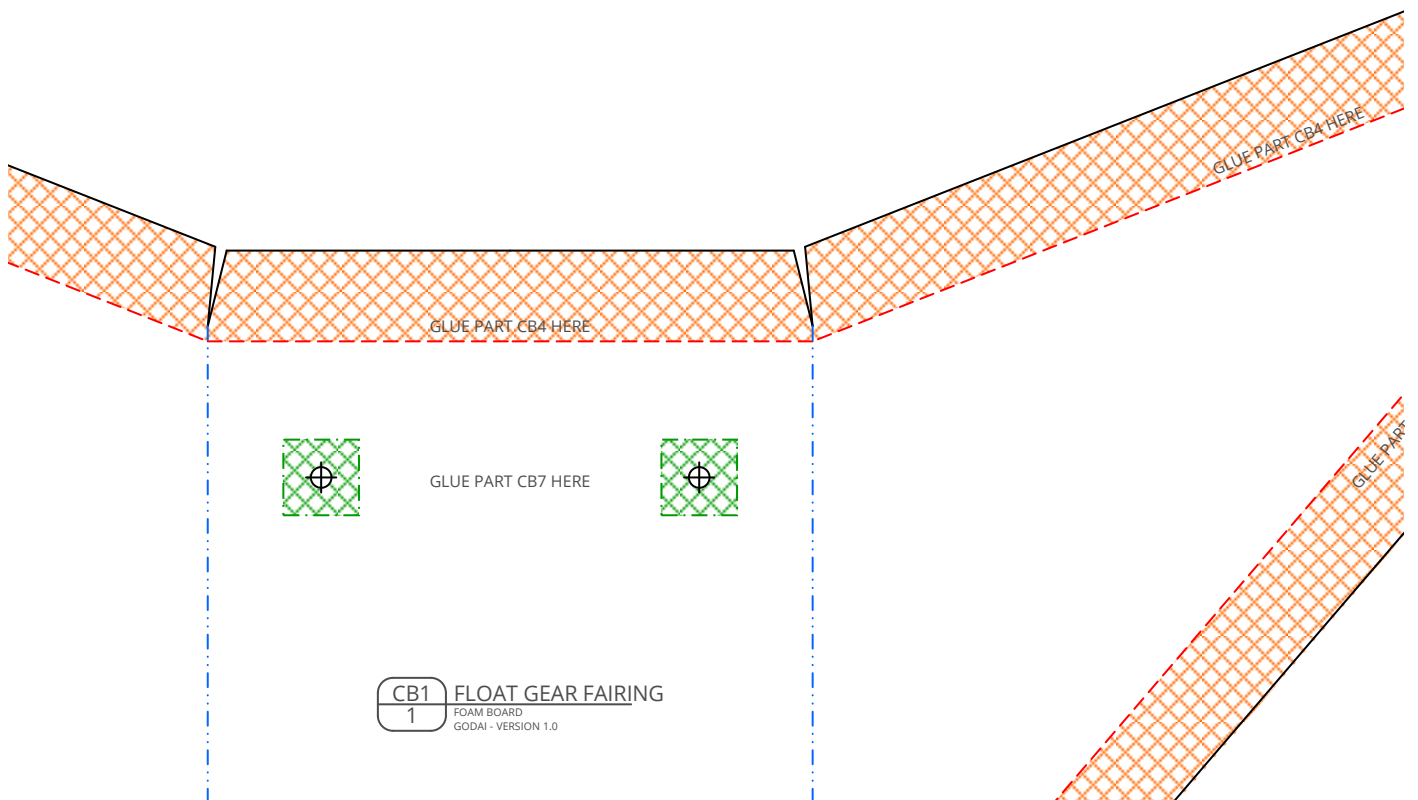

FLOATS - VERSION 1.0 (2017-08-18)

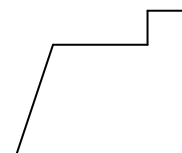
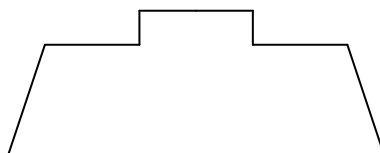
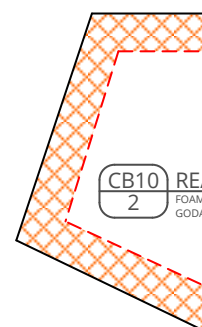
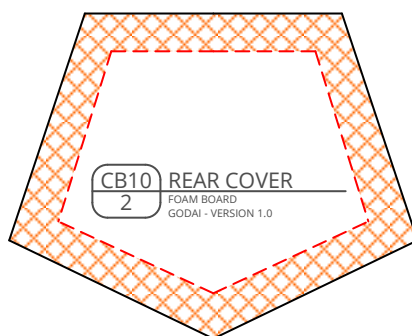
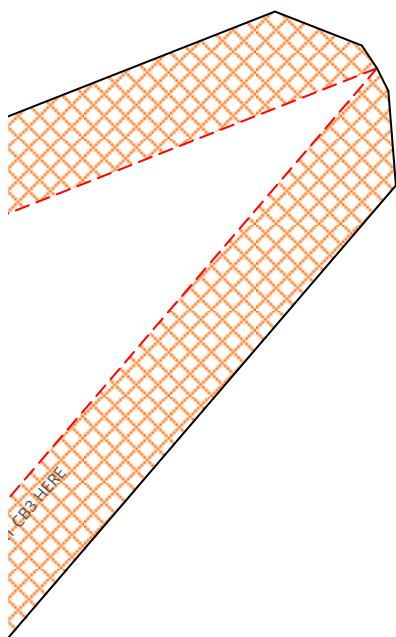

in
cm

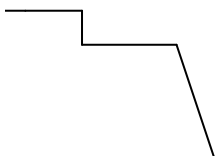
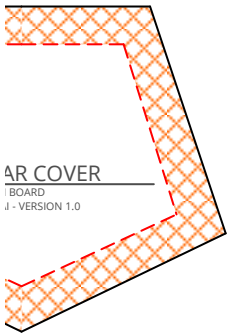



SECTION CB - SHEET 1 OF 3

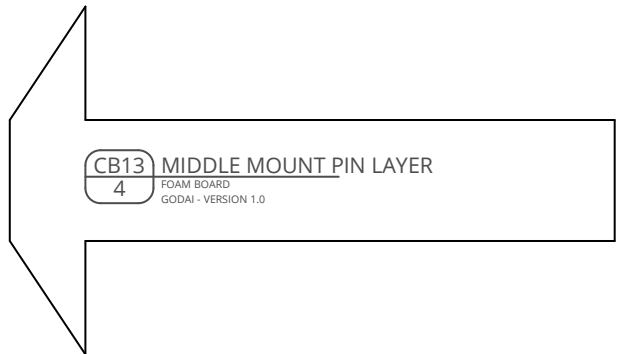
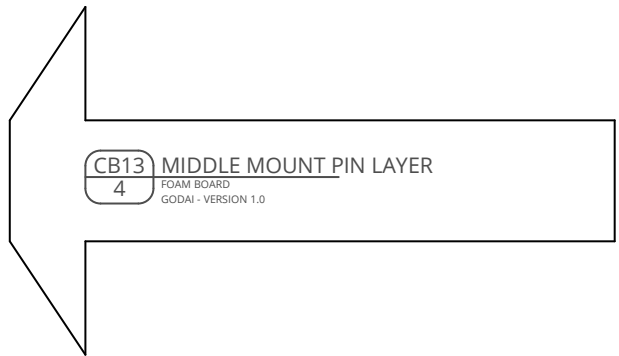
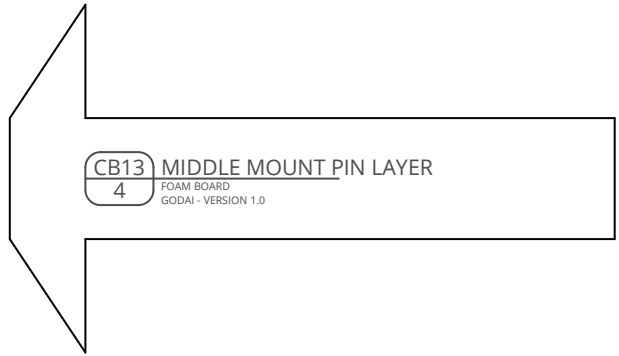
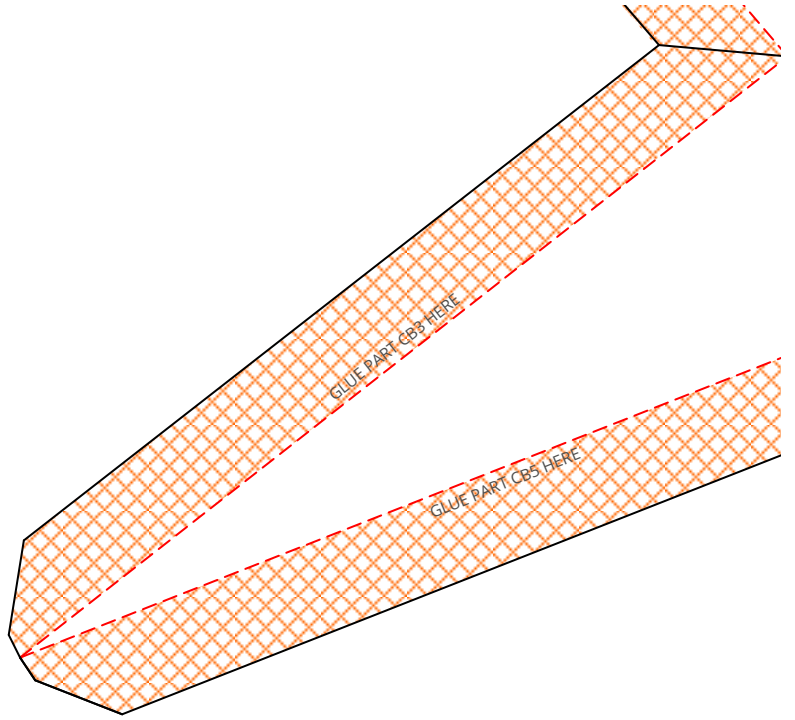

shorten the length of the pin until it fits in the float!

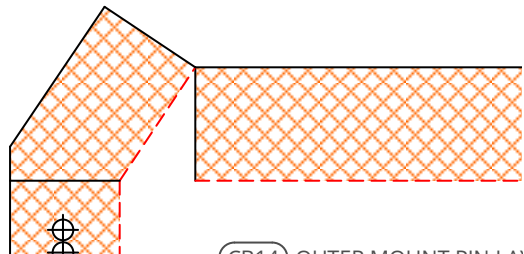
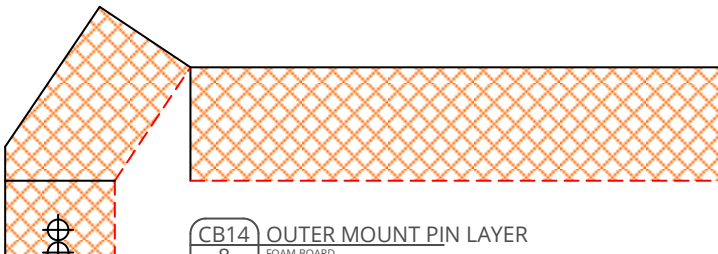
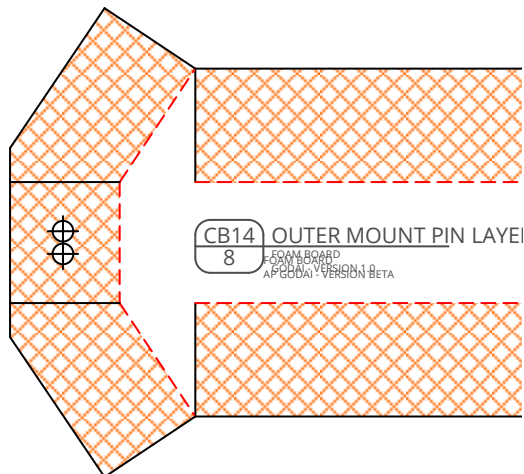
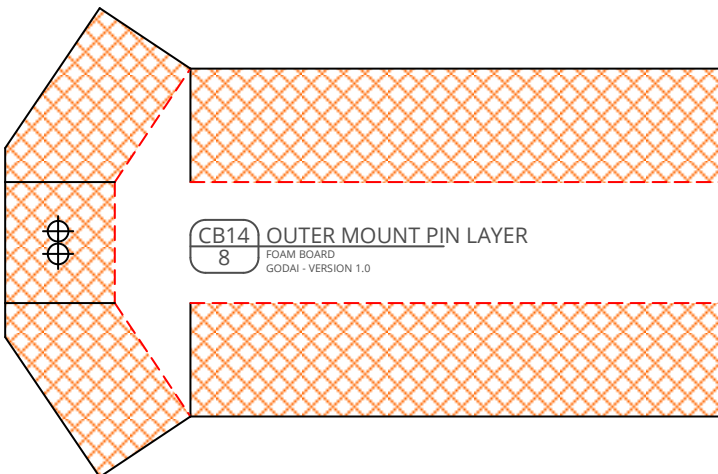
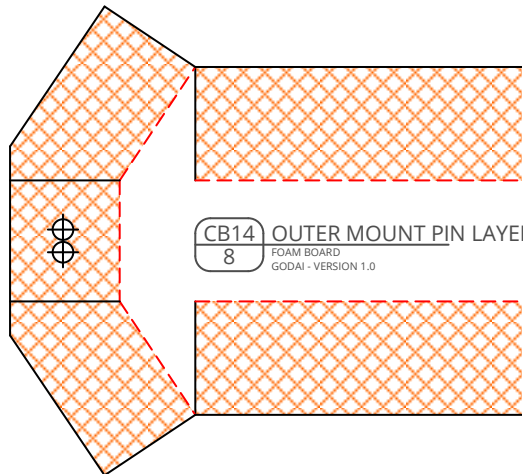
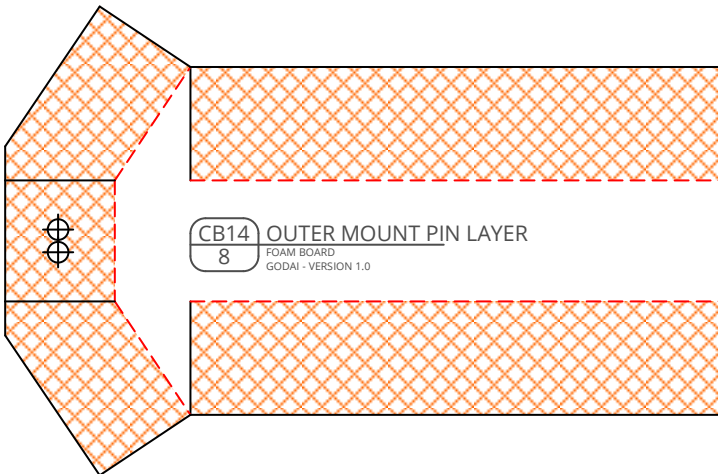
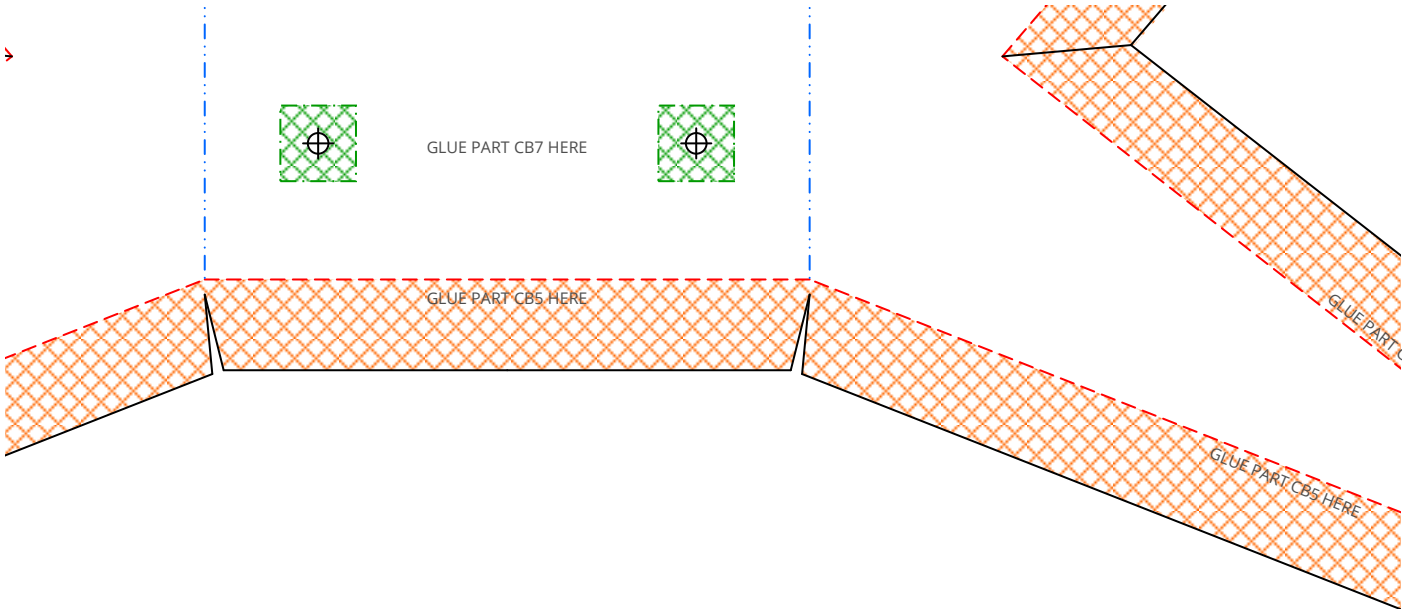

CB9 MIDDLE FORMER
2 FOAM BOARD
GODAI - VERSION 1.0

CB9 MIL
2 FOAM
GODAI

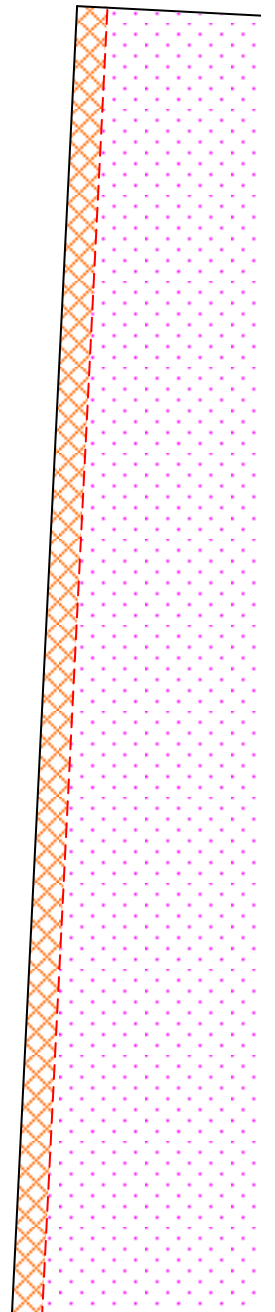
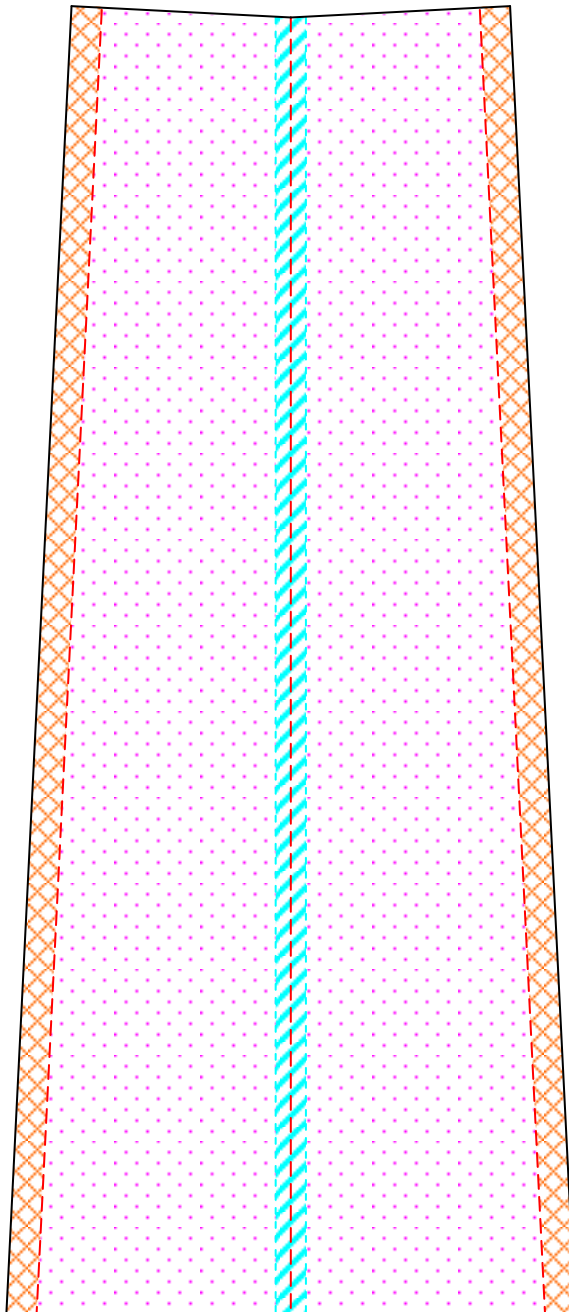
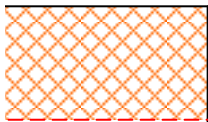
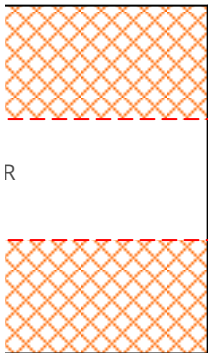
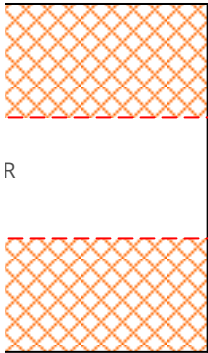
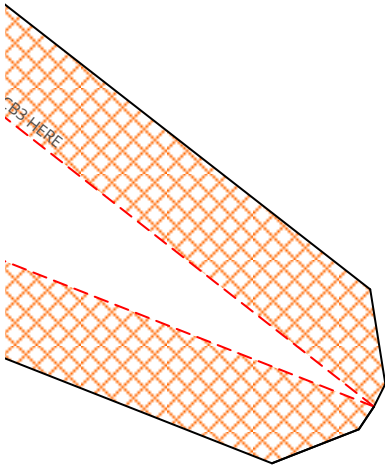

DLE FORMER
BOARD
- VERSION 1.0

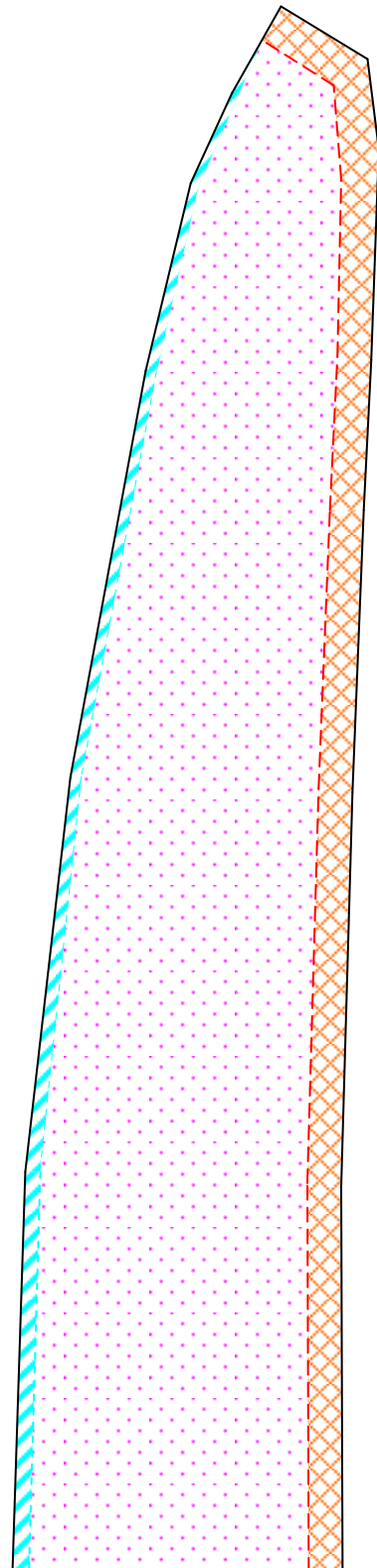
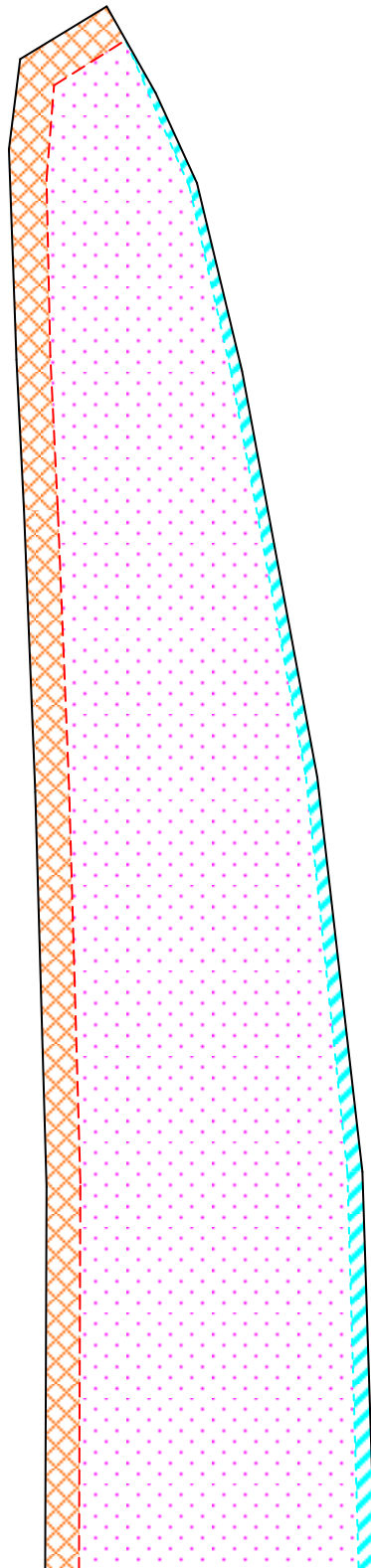
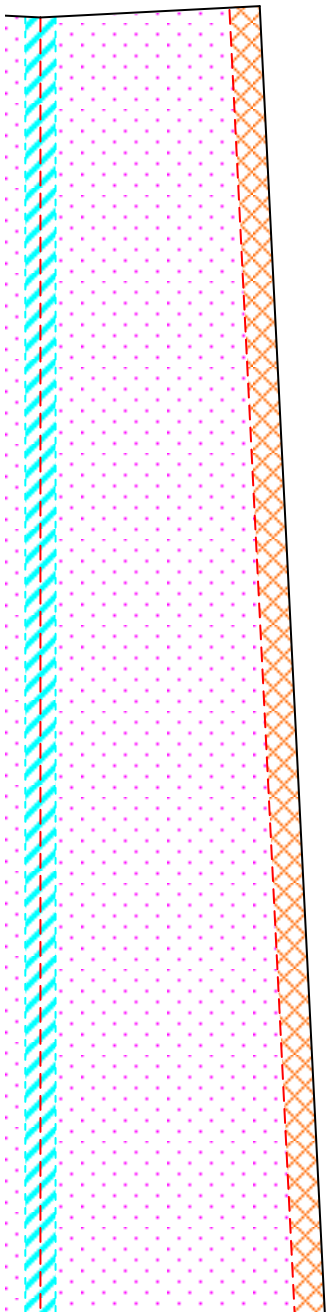

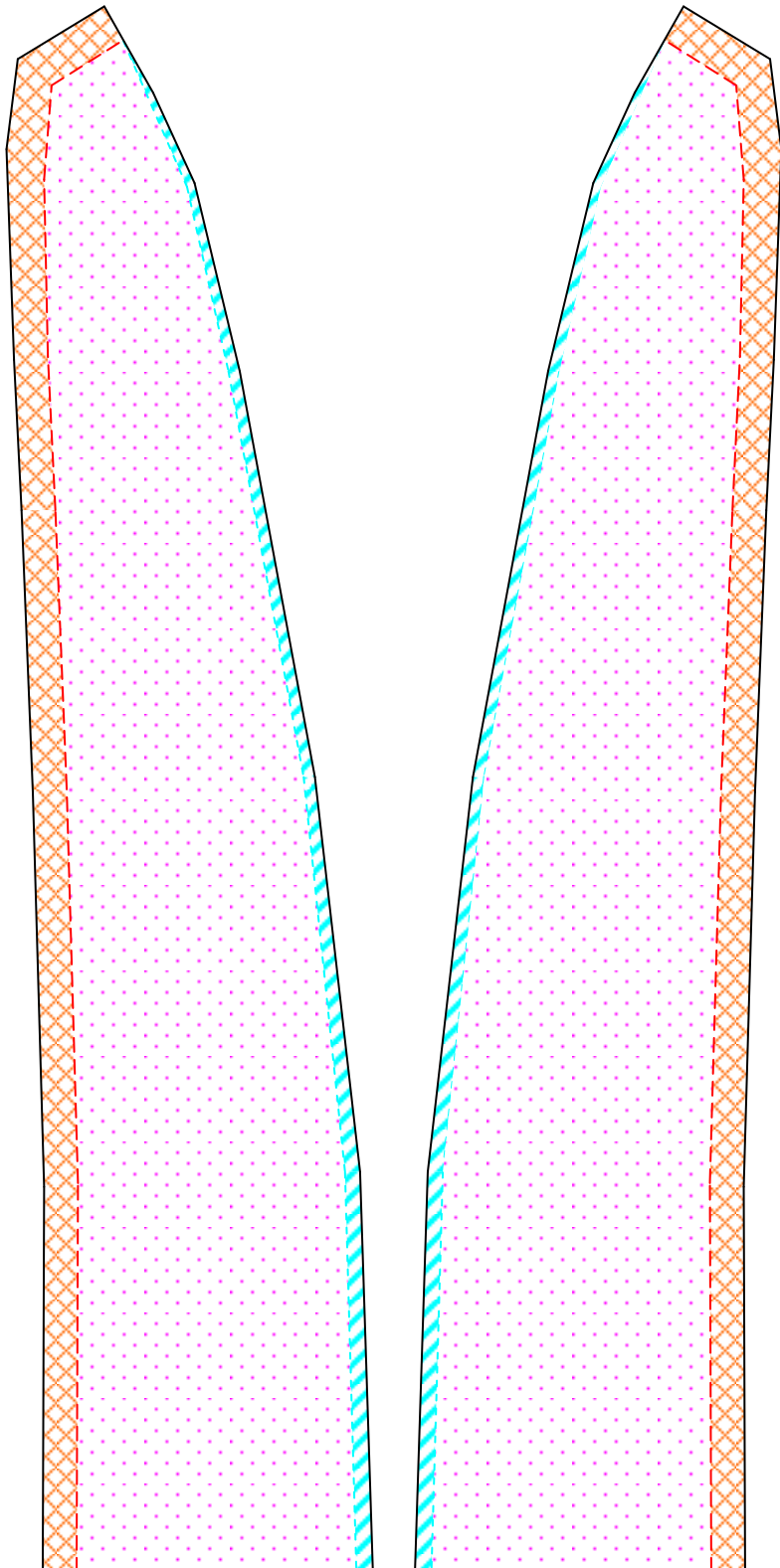

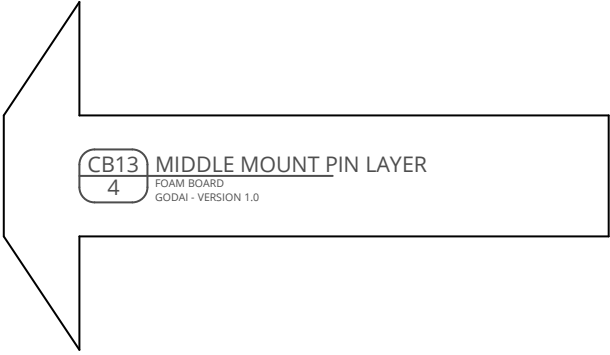

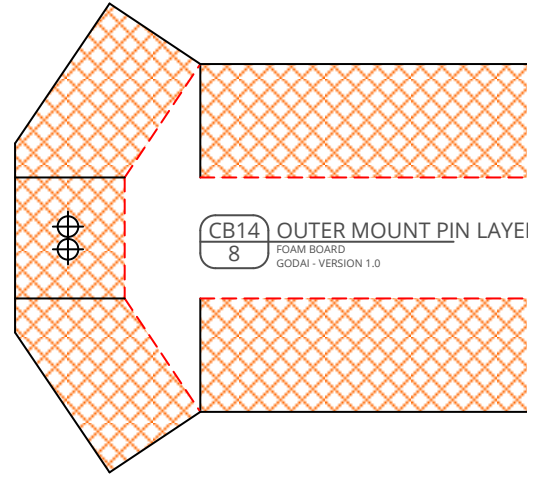
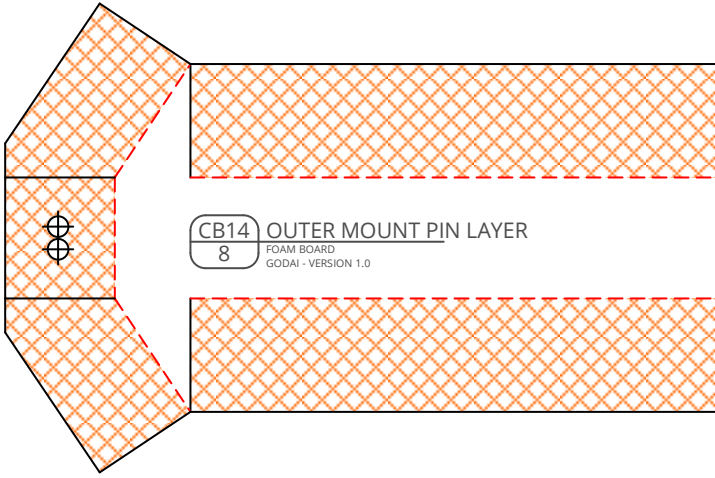
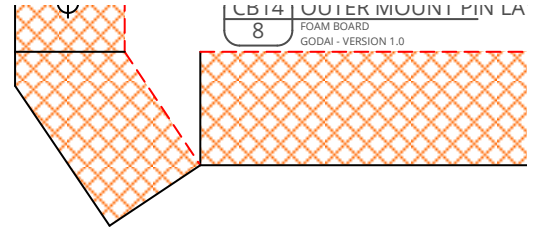
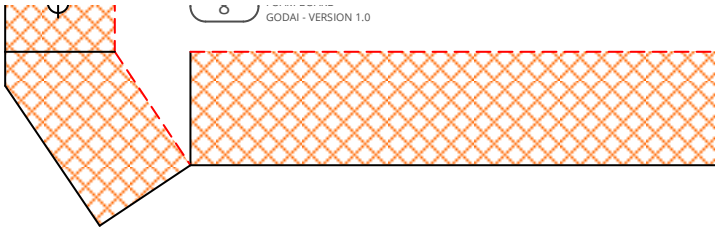

YER

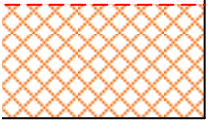

R

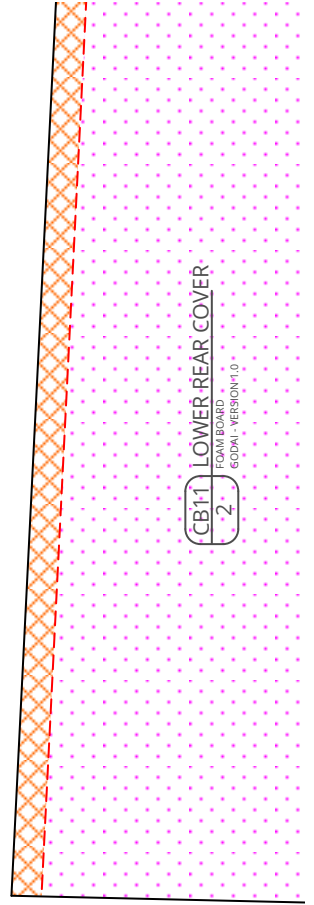
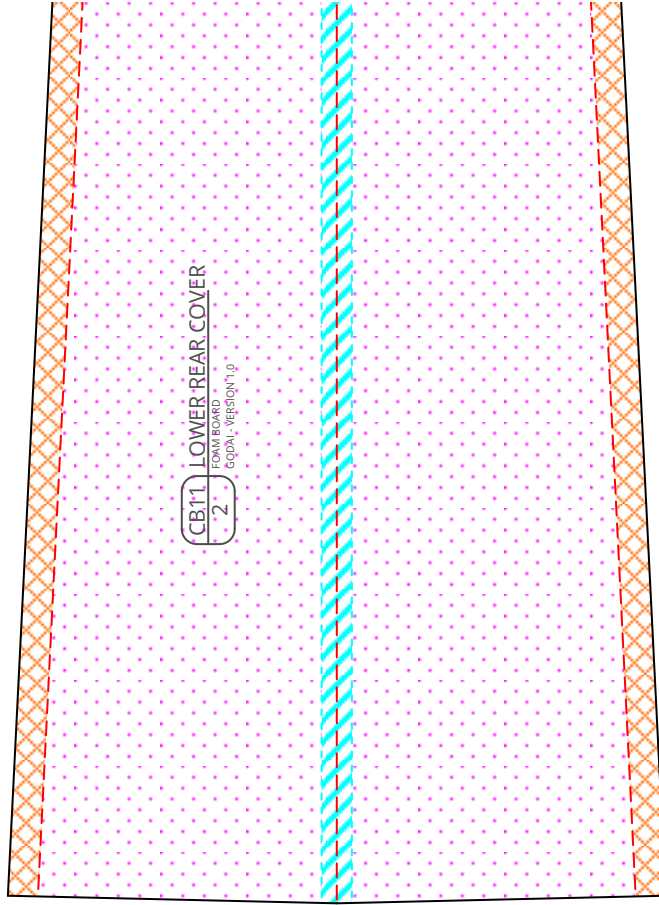
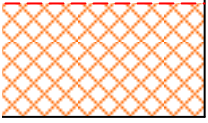
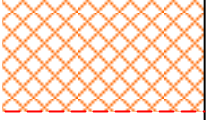

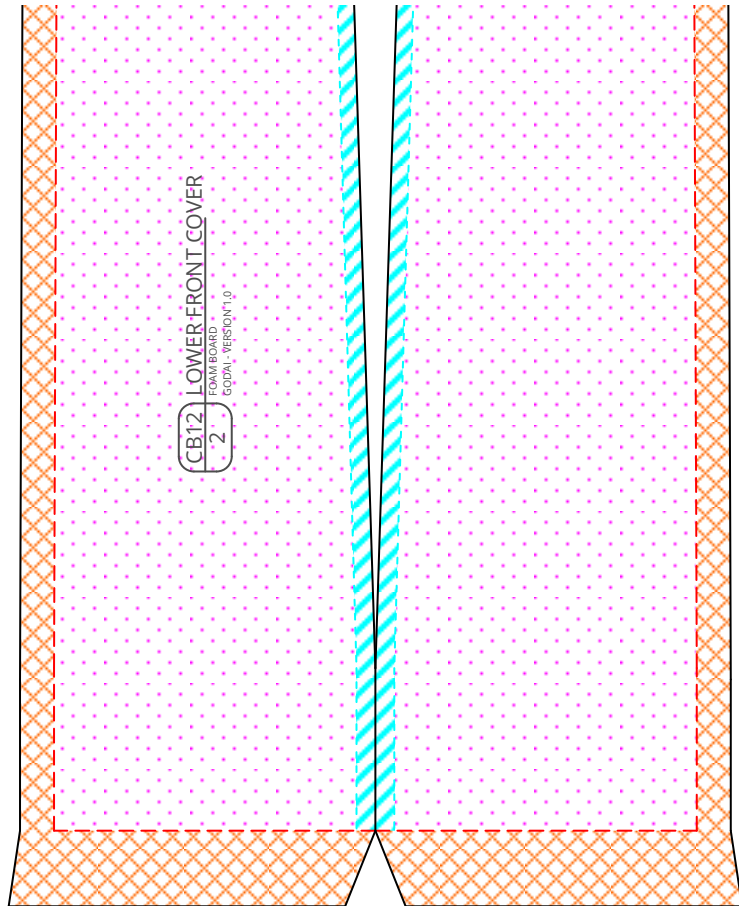
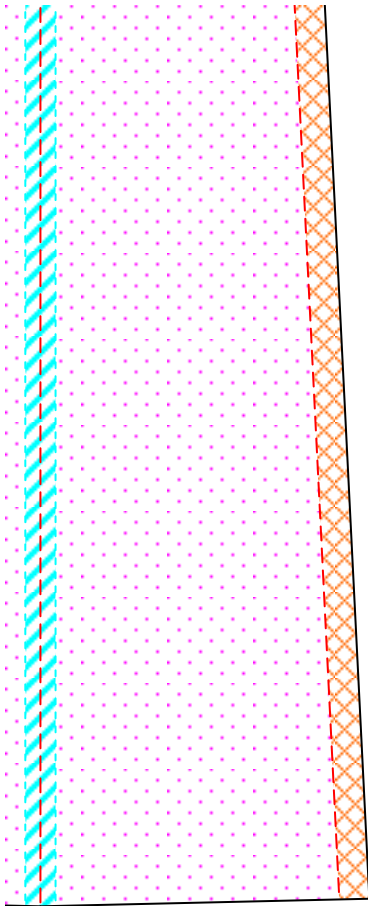

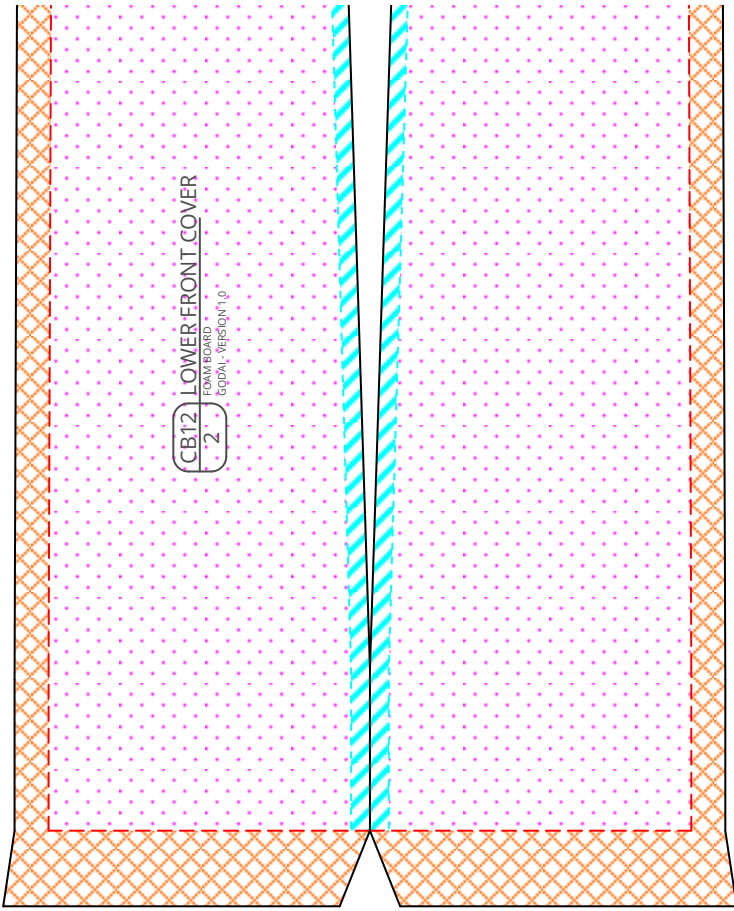

vided free of charge. Copies allowed for personal use only. Not for commercial use.

AP Godai - SECTION

Design & Drawing by: Tony Roehling

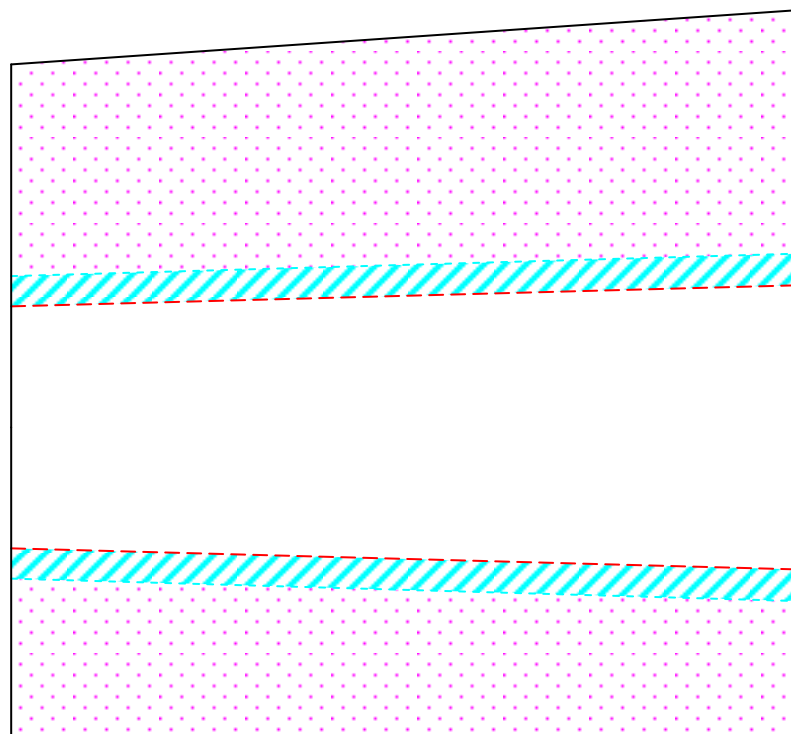

N CB - UNDERCARRIAGE WITH

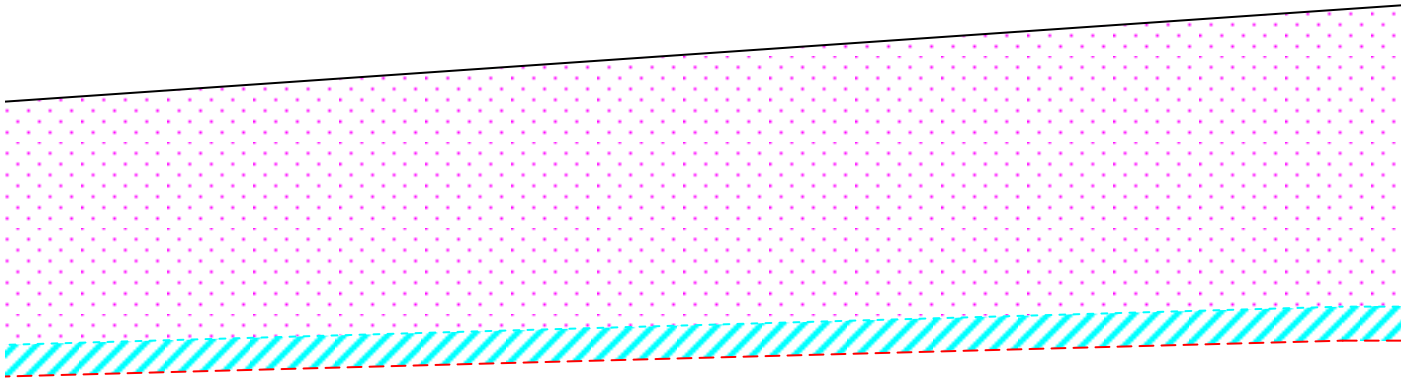

HOLE
FOR
PIN

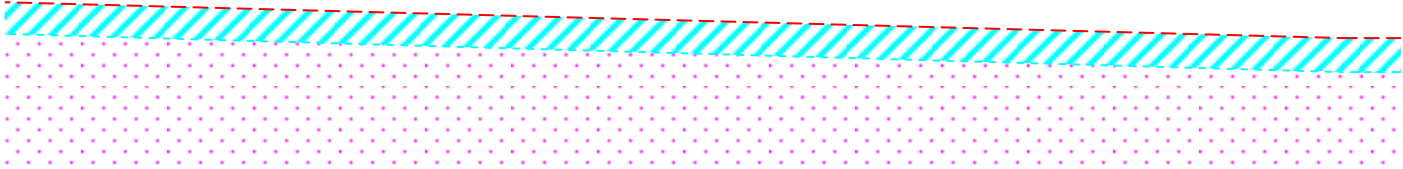

FLOATS - VERSION 1.0 (2017-08-18)

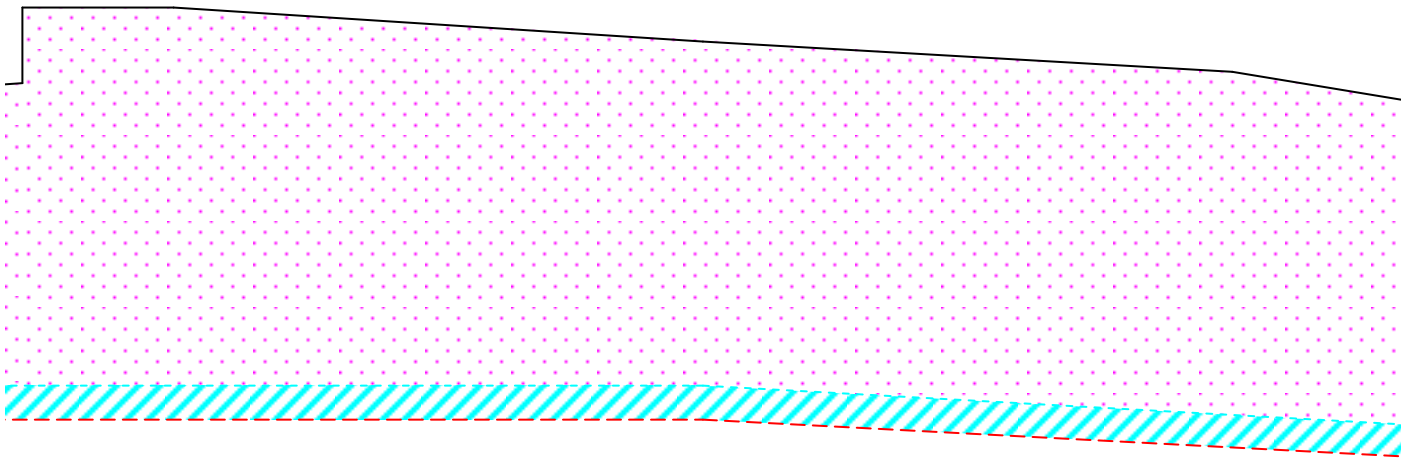

CB8 FLOAT
2 FOAM BOARD
GODAI - VERSION 1.0

HOLE
FOR
PIN

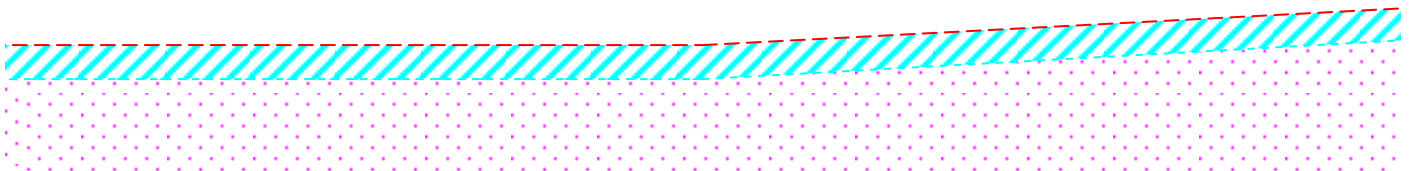

in
cm

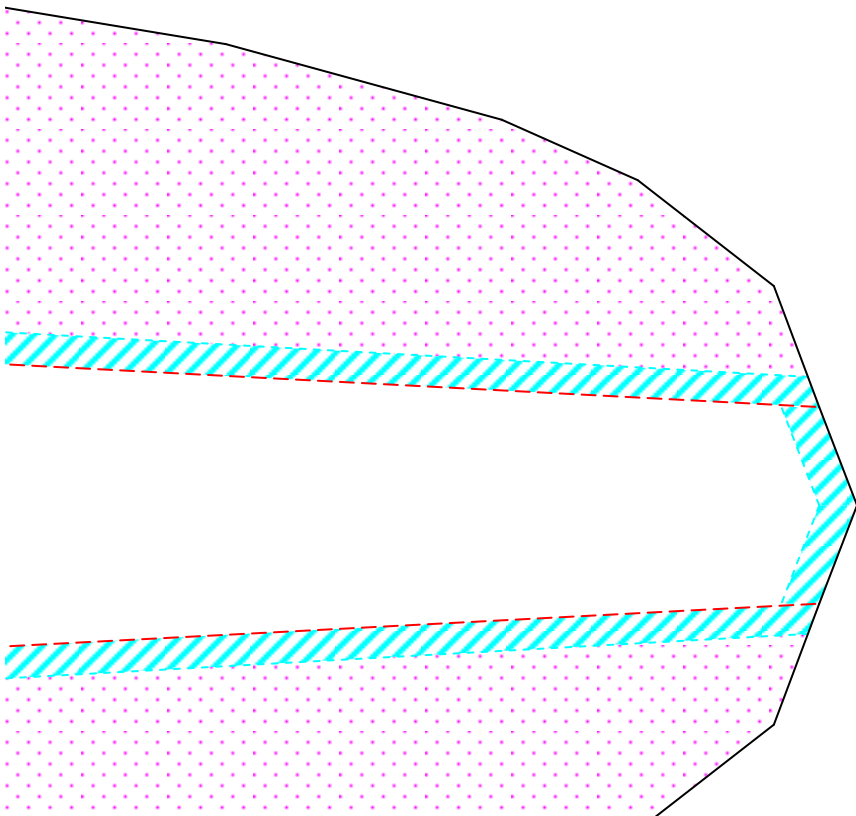



SECTION CB - SHEET 2 OF 3

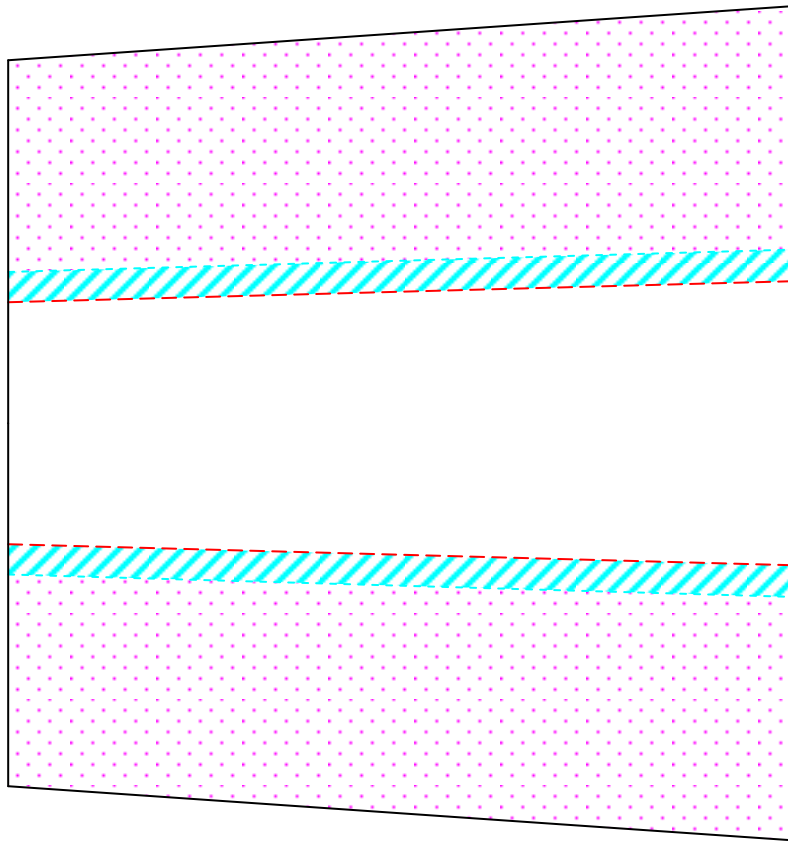
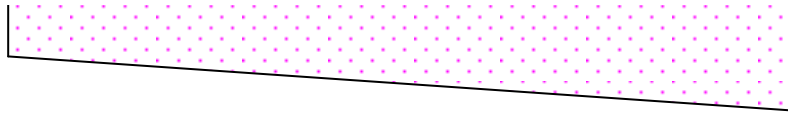

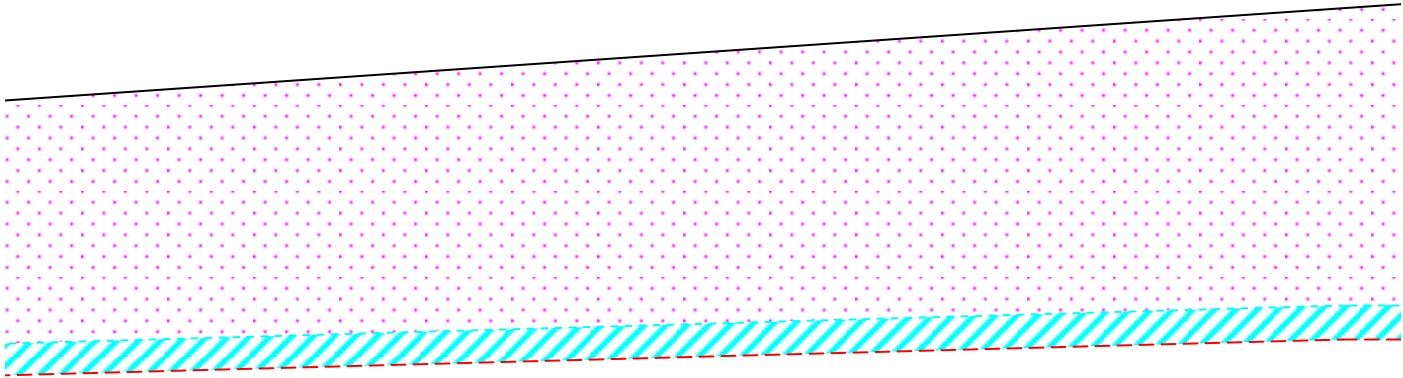
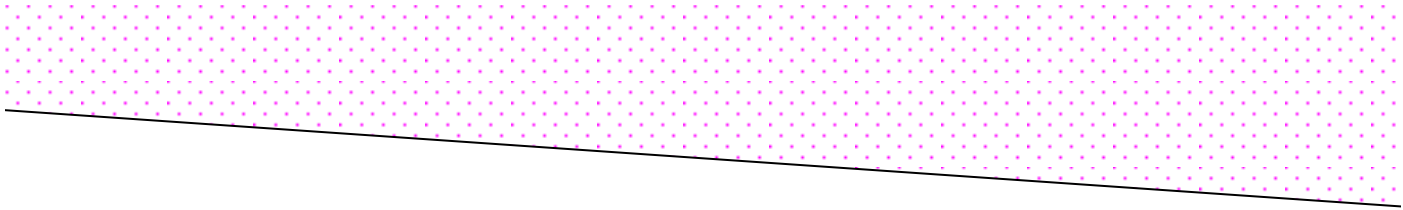

HOLE
FOR
PIN

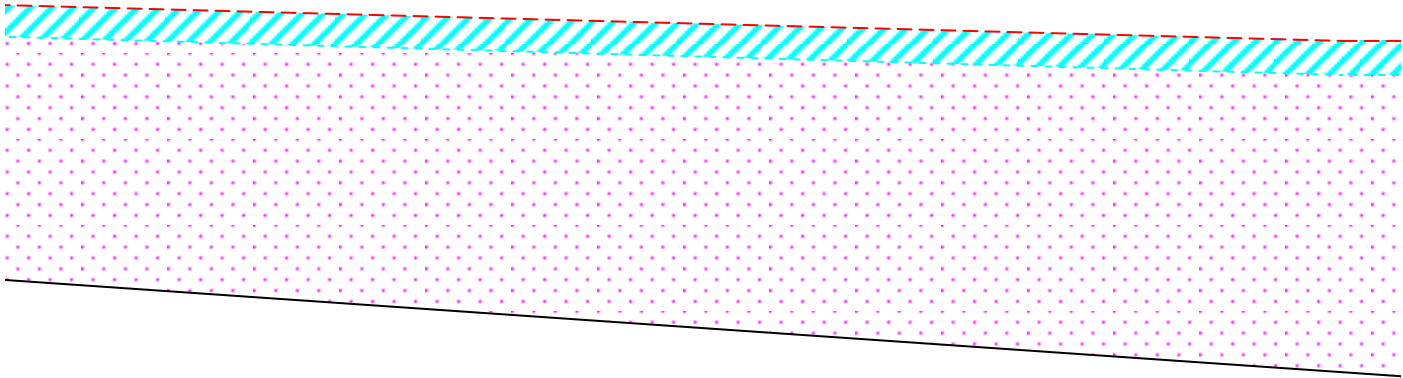

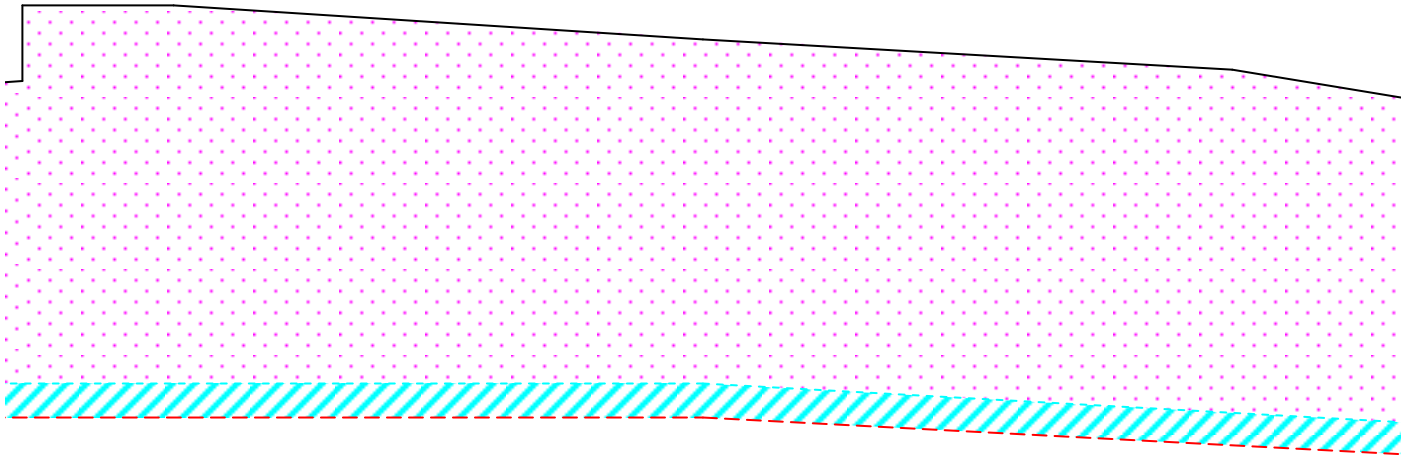
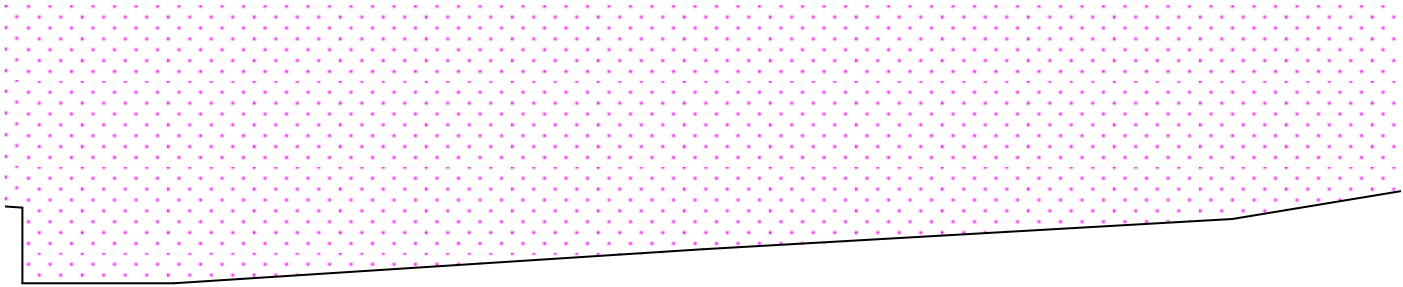

CB8 FLOAT
2 FOAM BOARD
GODAI - VERSION 1.0

HOLE
FOR
PIN

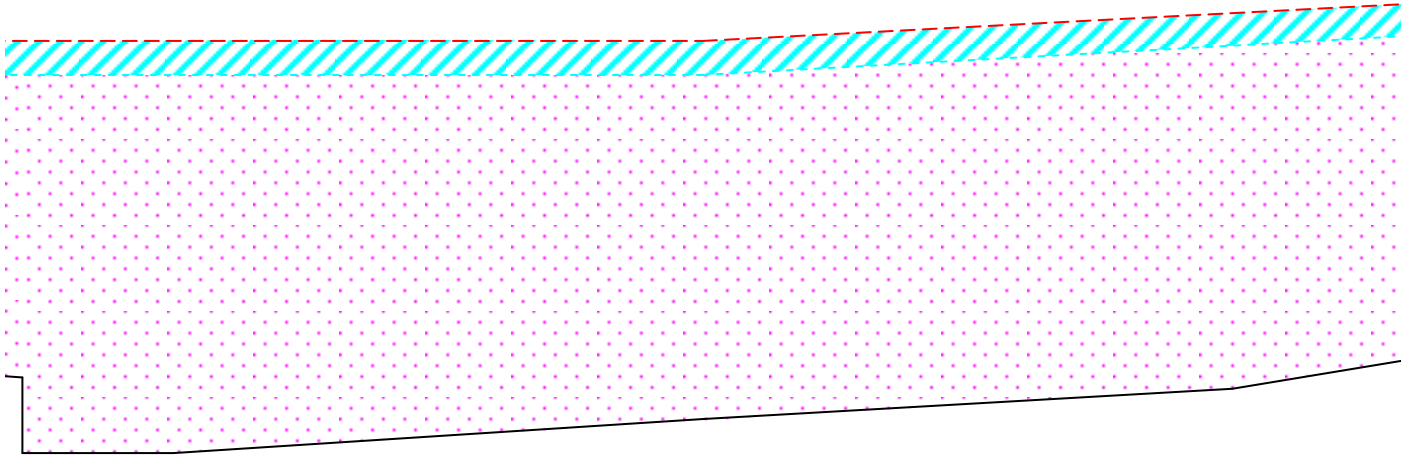

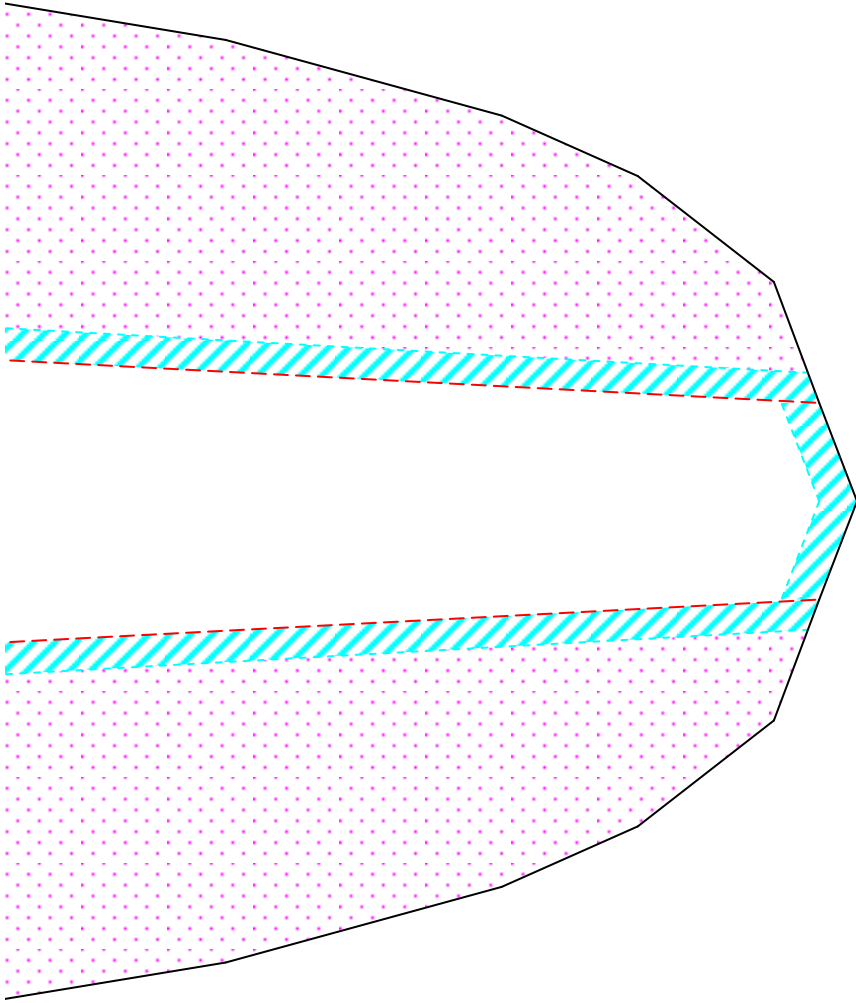
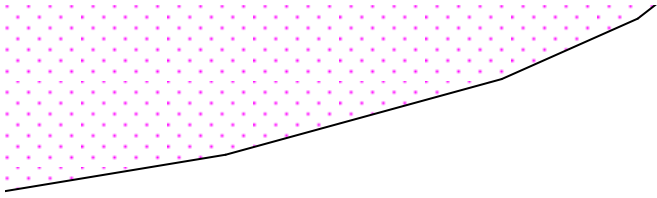





airc-pirates.com



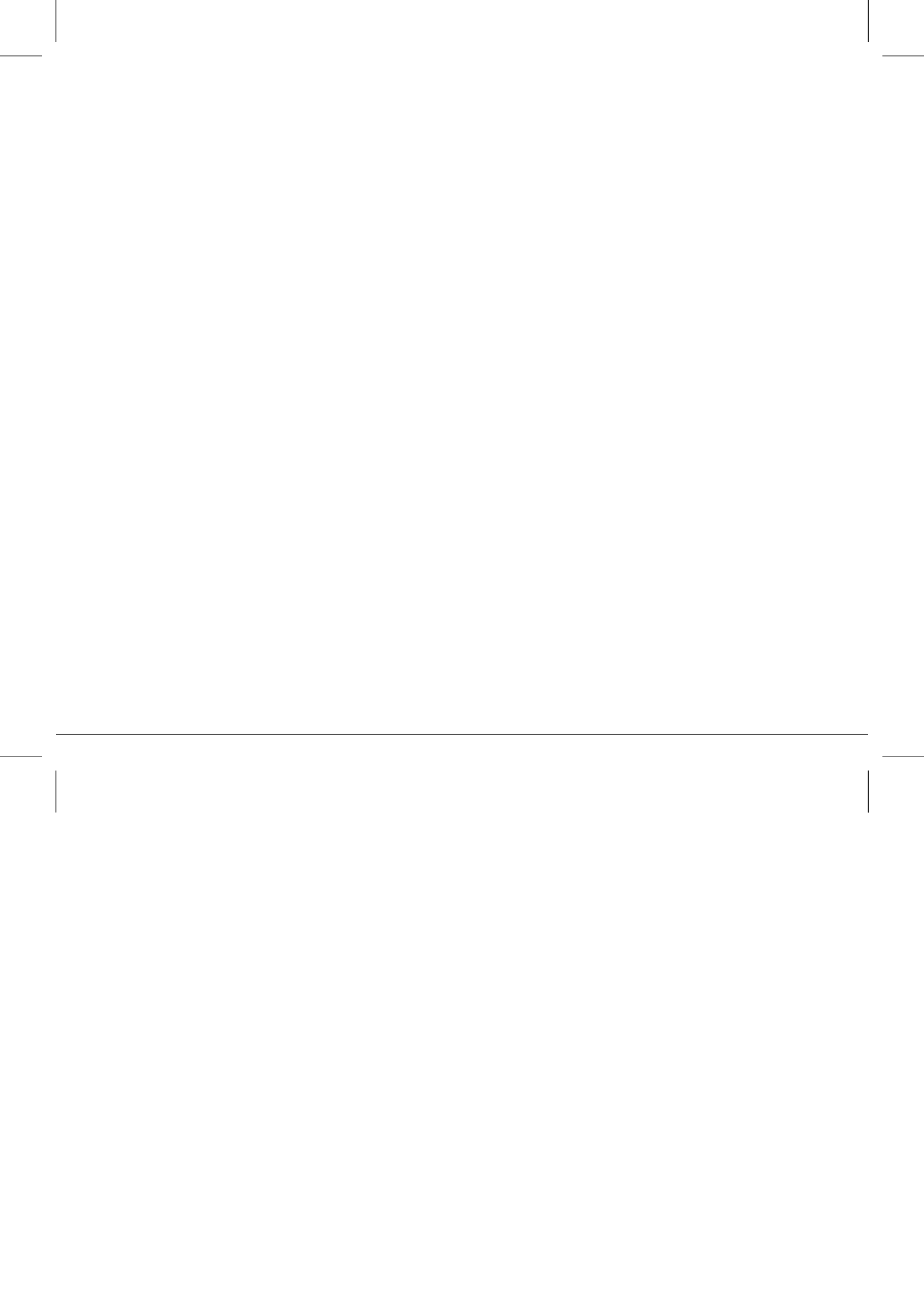

vided free of charge. Copies allowed for personal use only. Not for commercial use.

AP Godai - SECTION

Design & Drawing by: Tony Roehling

PARTS MADE OF STEEL WIRE (min. Ø 2mm)

137mm (5.39in)

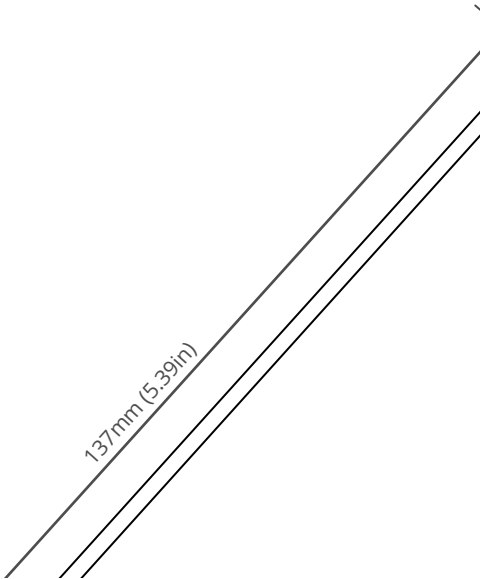
A technical drawing showing a diagonal line with a dimension label '137mm (5.39in)'. The line is drawn with two parallel lines, one solid and one dashed, indicating a specific measurement or offset.

N CB - UNDERCARRIAGE WITH

n | 0.08in)

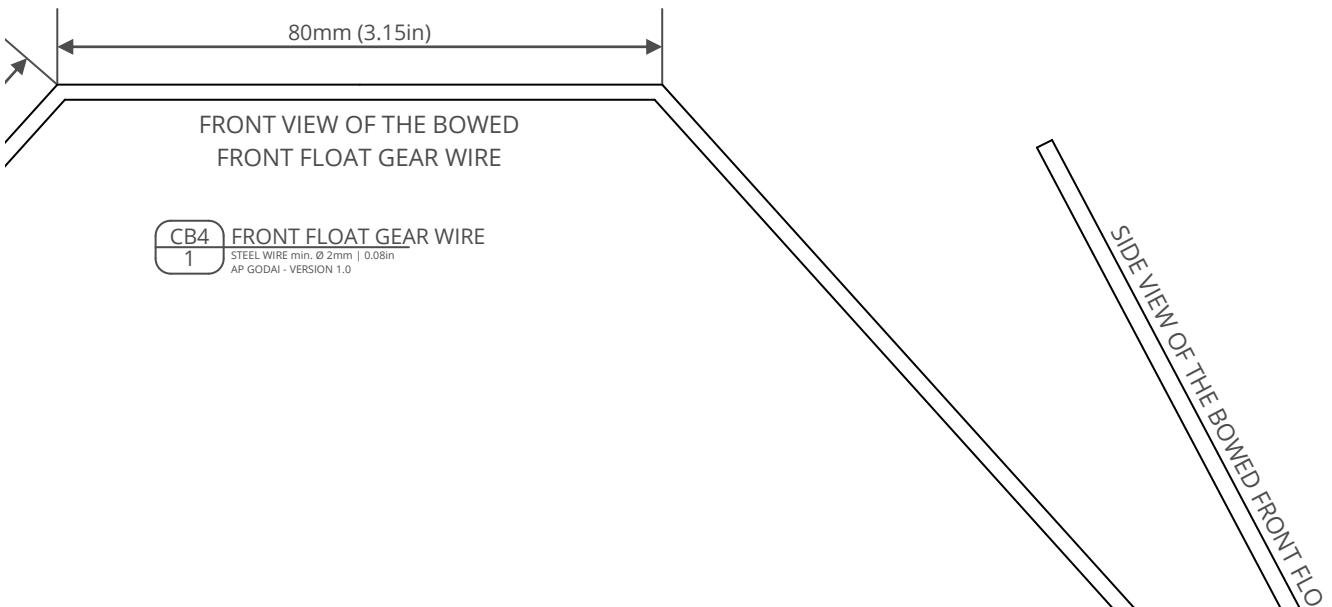

FLOATS - VERSION 1.0 (2017-08-18)

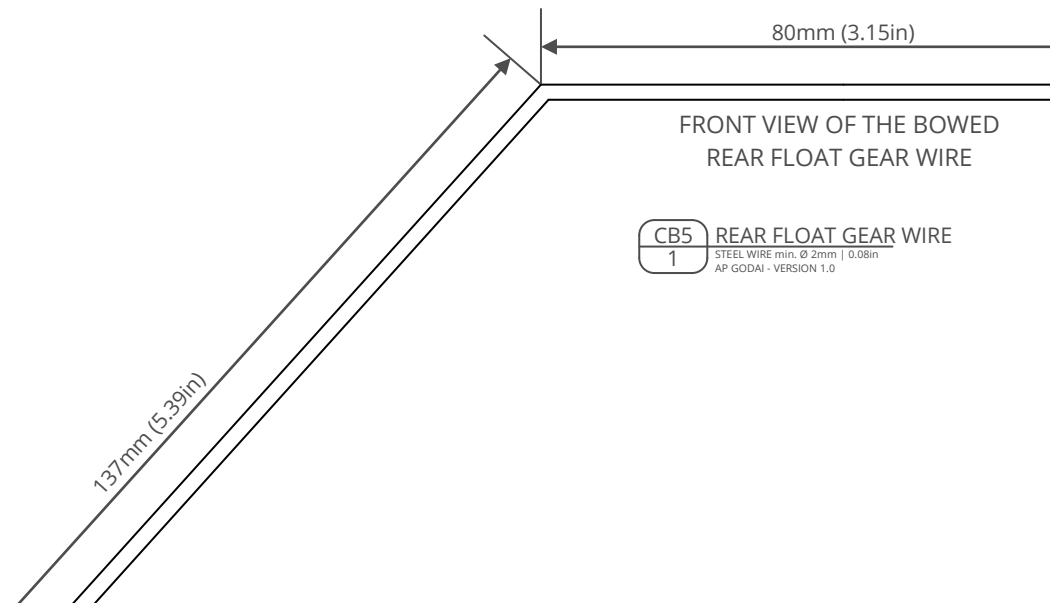

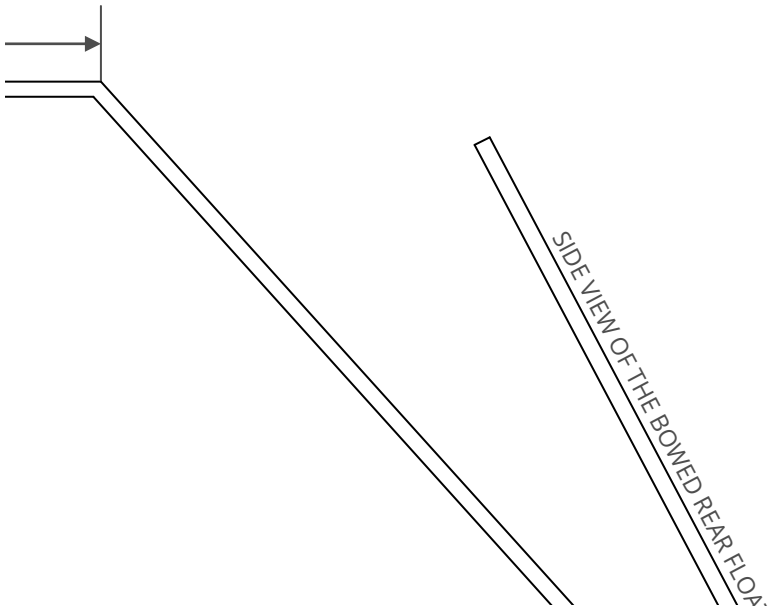

in

cm

PARTS MADE OF PLYWOOD

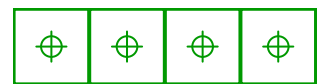

CB2 SCREW SPACER (OPTIONAL)
4

PLYWOOD max. 5mm | 0.19in
AP-GODAI - VERSION 1.0

PARTS MADE OF BBQ SKE



CB3 REINFORCEMENTS FOR PART CB1
2

BBQ SKEWER
GODAI - VERSION 1.0



CB3 REINFORCEMENTS FOR PART CB1
2

BBQ SKEWER
GODAI - VERSION 1.0



SECTION CB - SHEET 3 OF 3

ØD (max. 5mm | 0.19in)

WERS



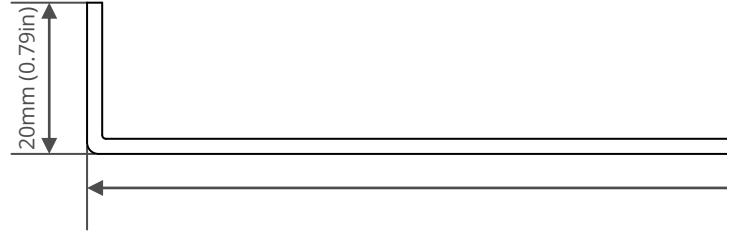
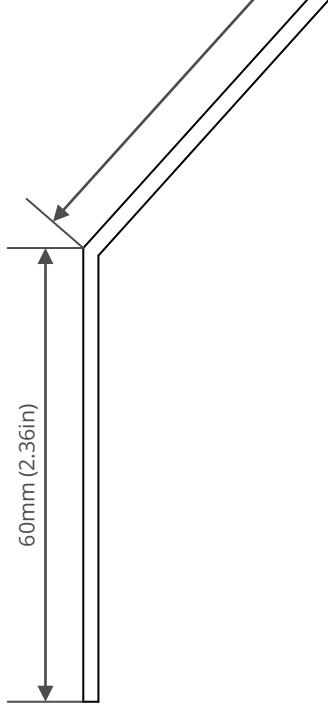

AT GEAR WIRE

CB6 SUPPORT ROD
2 STEEL WIRE min. Ø 2mm | 0.08in
AP GODAJ - VERSION 1.0

264mm (10.39in)

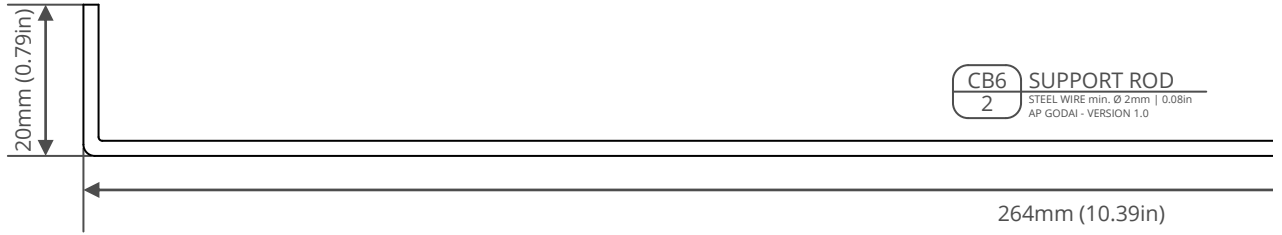
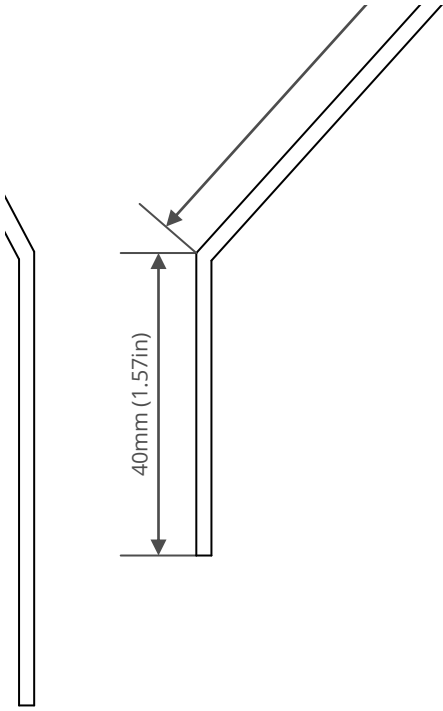

CB6 SUPPORT ROD
2 STEEL WIRE min. Ø 2mm | 0.08in
AP GODAI - VERSION 1.0

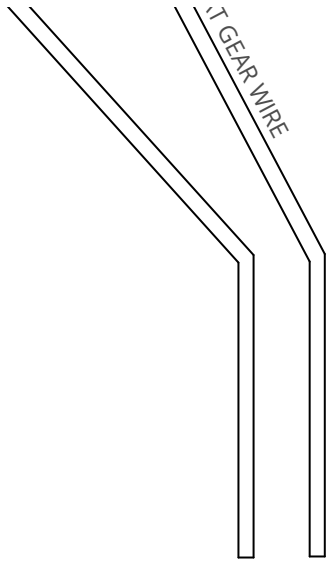

PARTS MADE OF PLASTIC



CB7
2

OUTER GEAR MOUN
PLASTIC CARD
GODAI - VERSION 1.0



CB7
2

OUTER GEAR MOUN
PLASTIC CARD
GODAI - VERSION 1.0

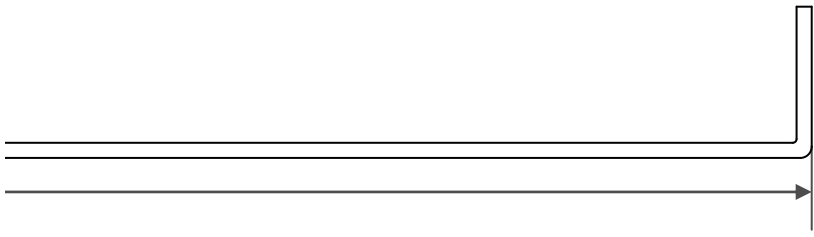

CARD

| | |
|---|----------|
| T | \oplus |
| T | \oplus |



airc-pirates.com





vided free of charge. Copies allowed for personal use only. Not for commercial use.