

# AP Godai - SECTION

Design & Drawing by: Tony Roehling

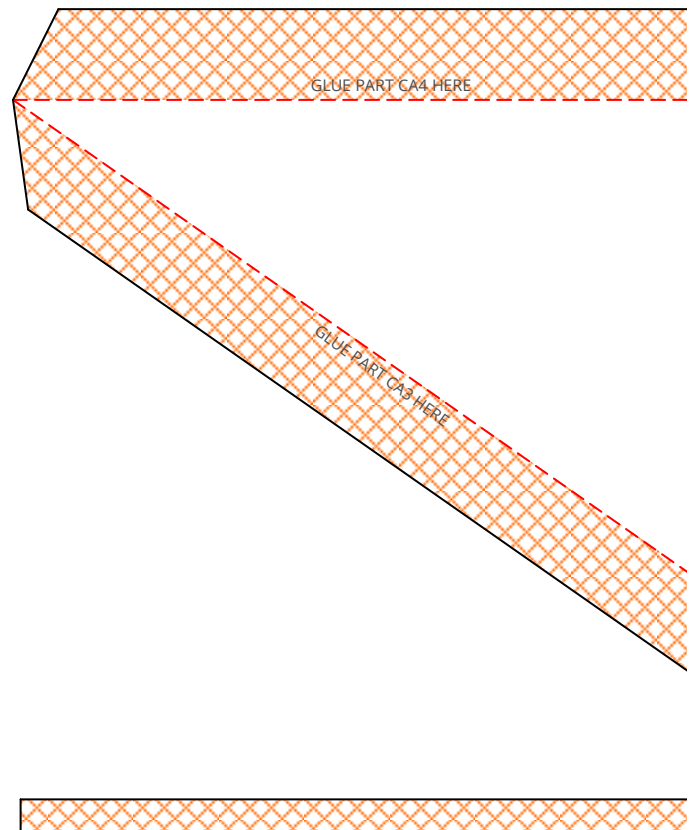

# N CA - UNDERCARRIAGE WITH

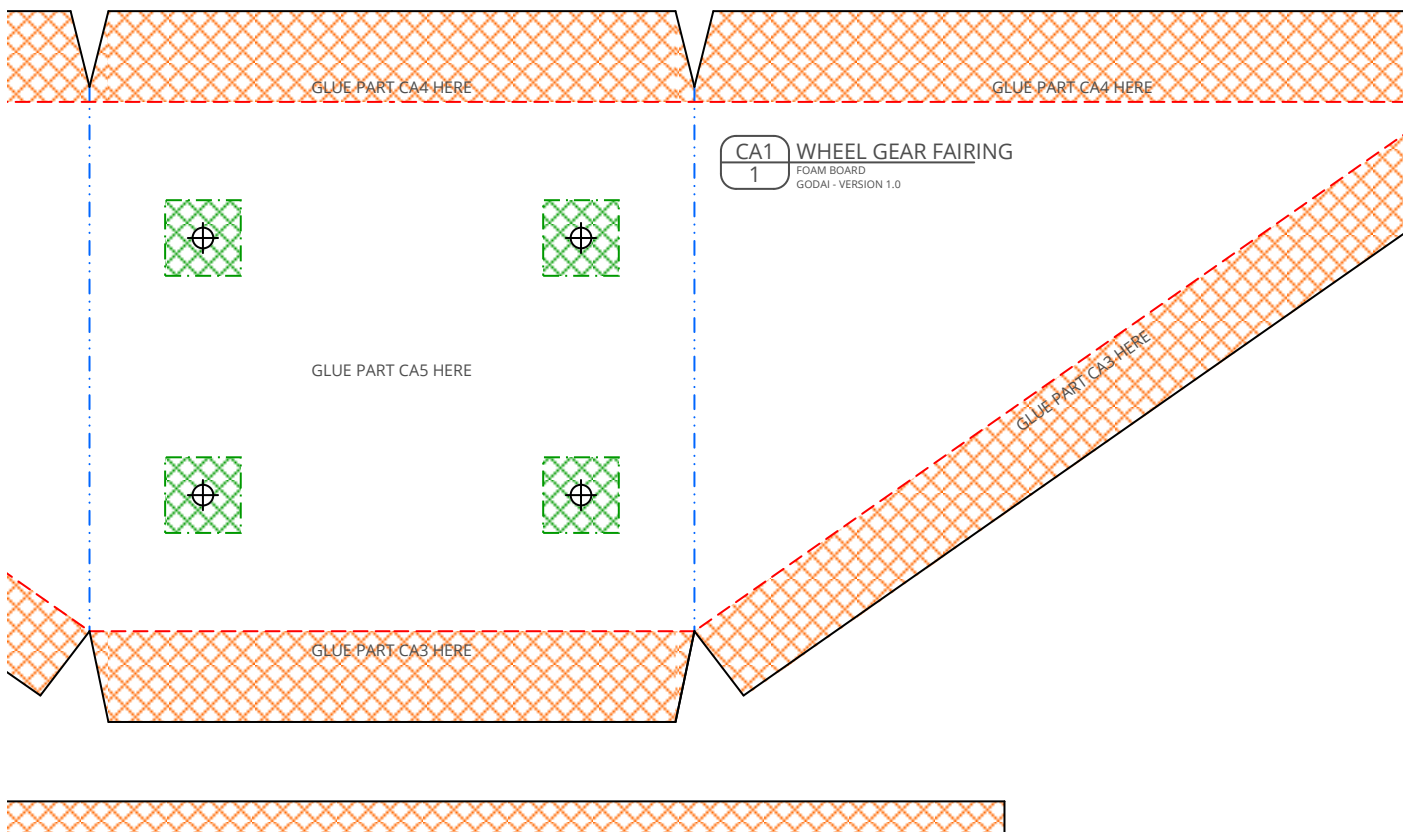

# WHEELS - VERSION 1.0 (2017-08-18)

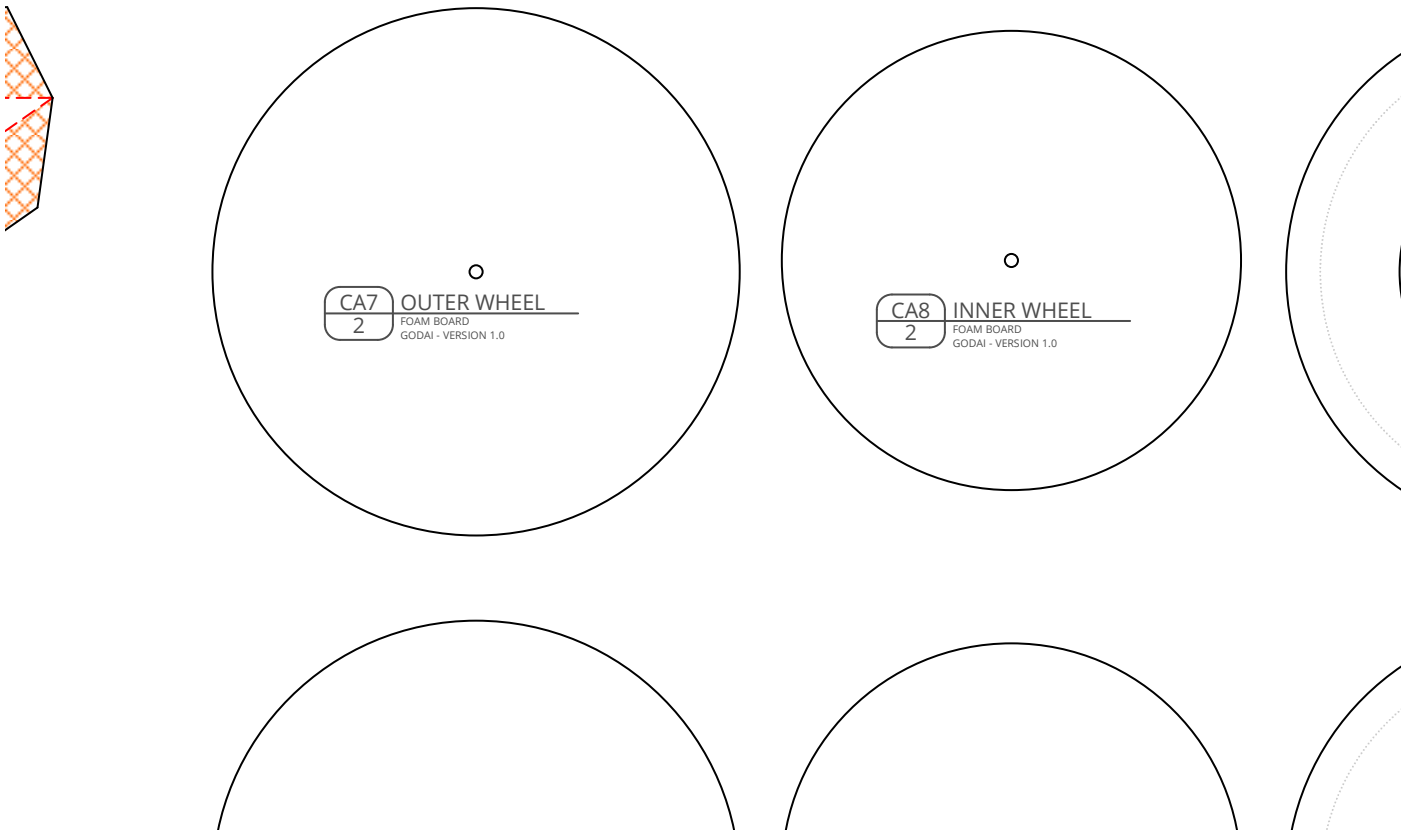

in   
cm 

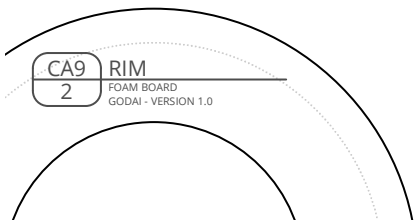
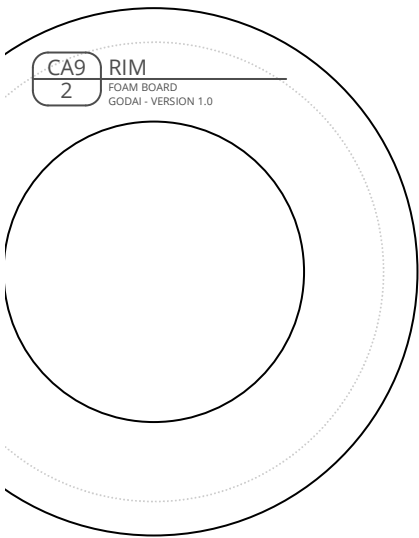

## PARTS MADE OF P



CA2 SCREW SPACER (OPT)  
4 PLYWOOD max. 5mm | 0.19in  
AP GODAI - VERSION 1.0

## PARTS MADE OF B



CA3 REINFORCEMENTS F  
1 BBQ SKEWER  
GODAI - VERSION 1.0

## PARTS MADE OF P

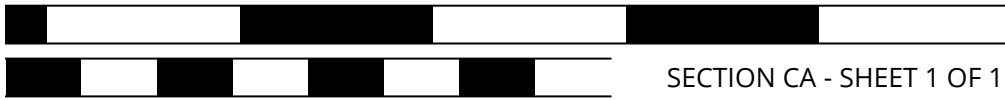

**PLYWOOD (max. 5mm | 0.19in)**

[  
TIONAL)

**BBQ SKEWERS**



OR PART CA1

**PLASTIC CARD**

CA10 TII  
2 FOA  
GOT



CA10 TII  
2 FOA  
GOT



### PARTS MADE OF STEEL WIRE (min. Ø 2r)

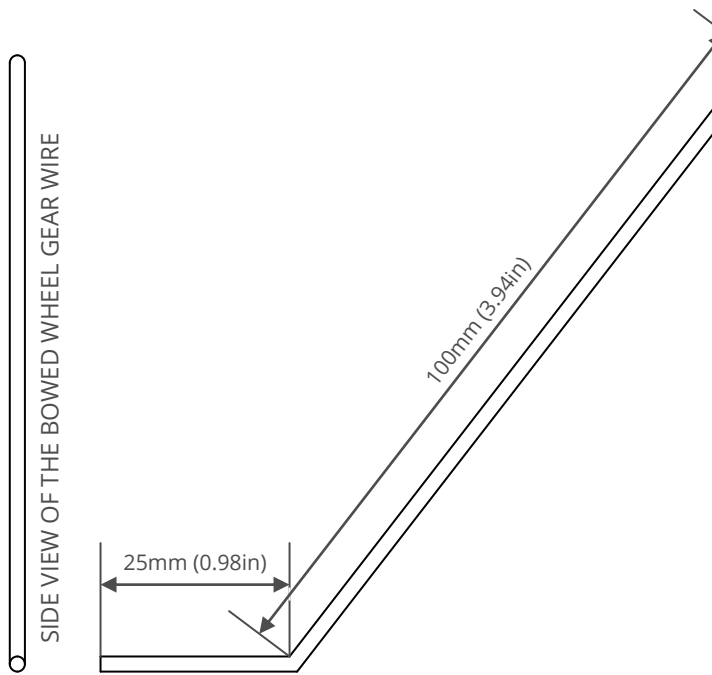

RE TREAD

M BOARD  
JAI - VERSION 1.0



RE TREAD

M BOARD  
JAI - VERSION 1.0



mm | 0.08in)

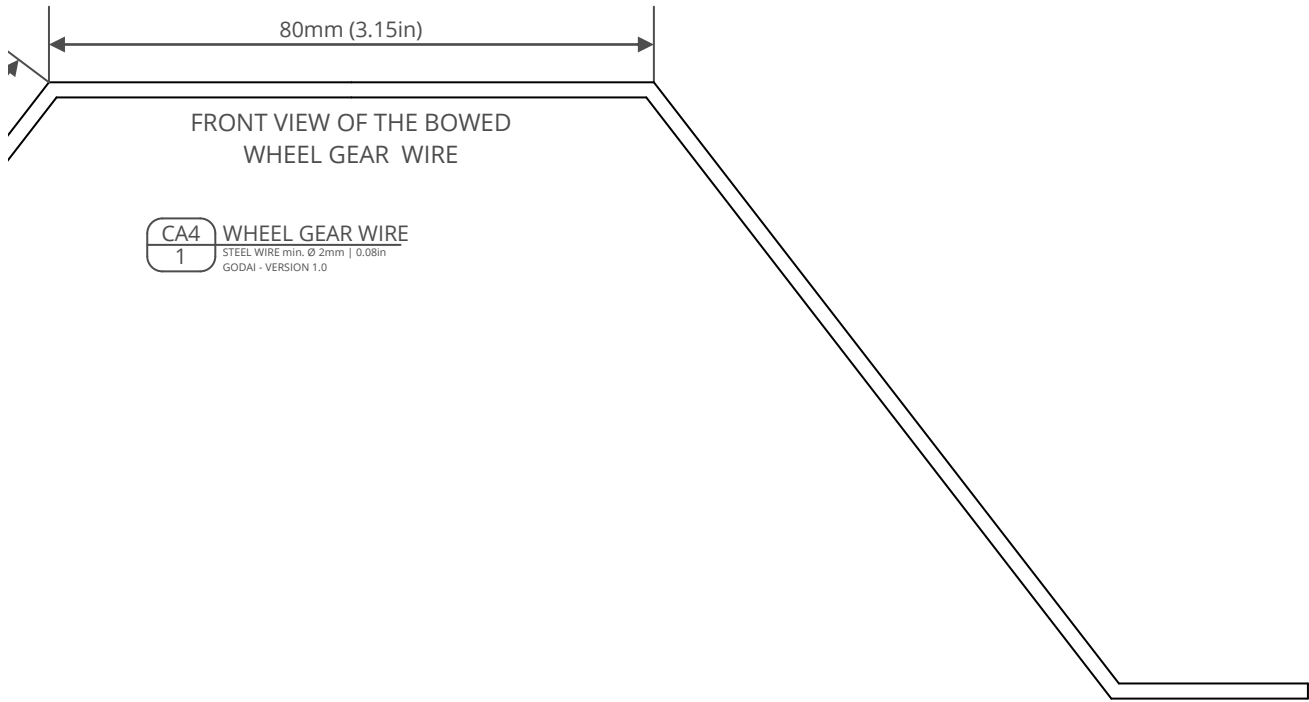

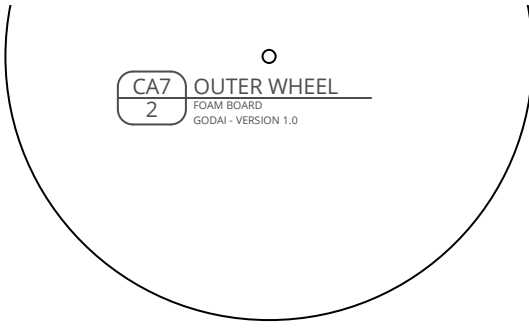



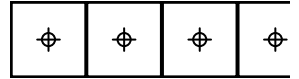
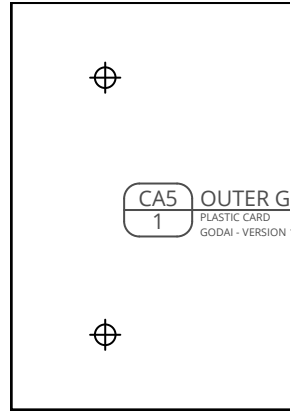
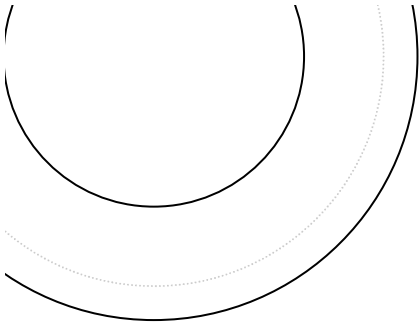

EAR MOUNT

1.0



LR WHEEL HOLE



[airc-pirates.com](http://airc-pirates.com)

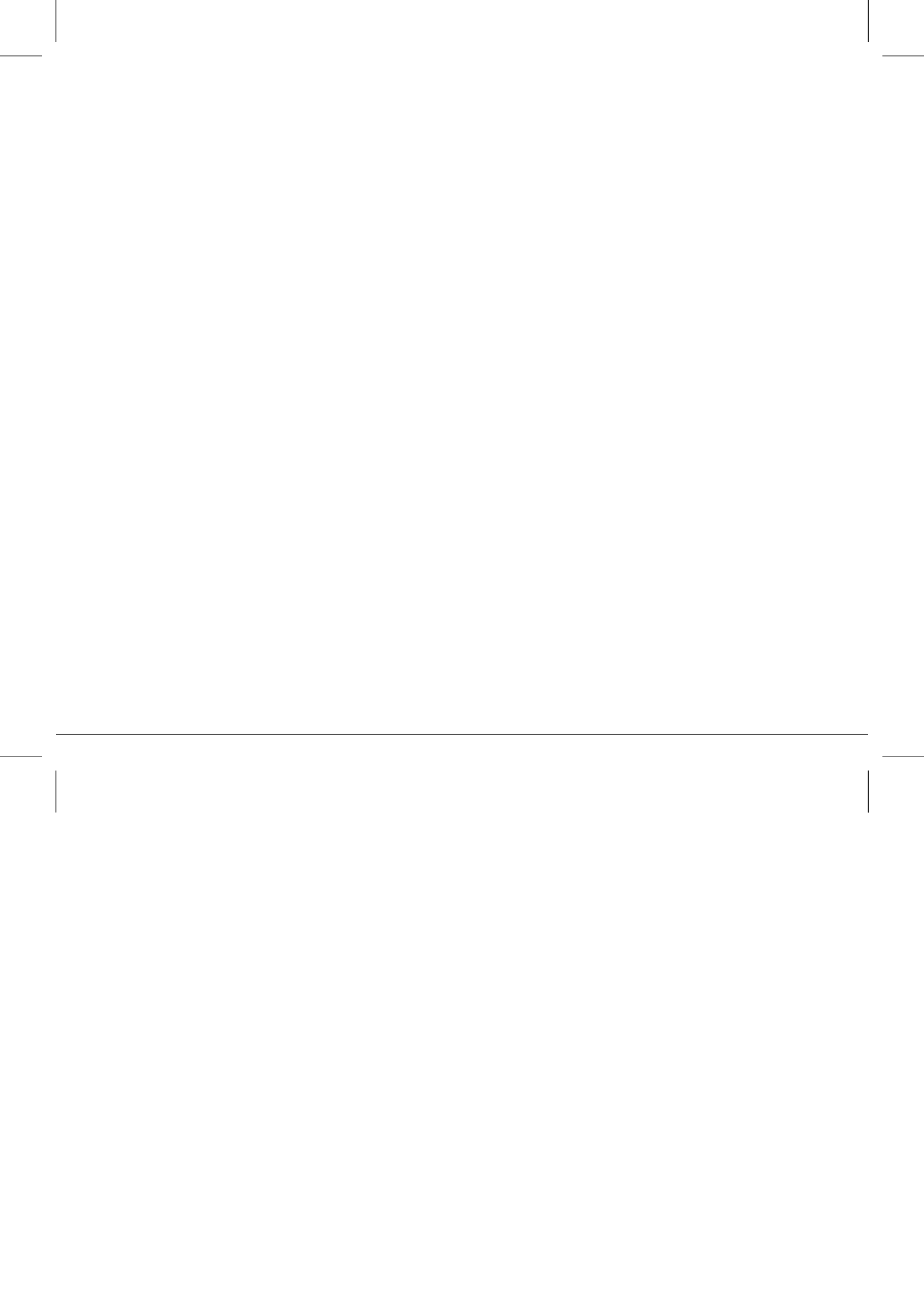

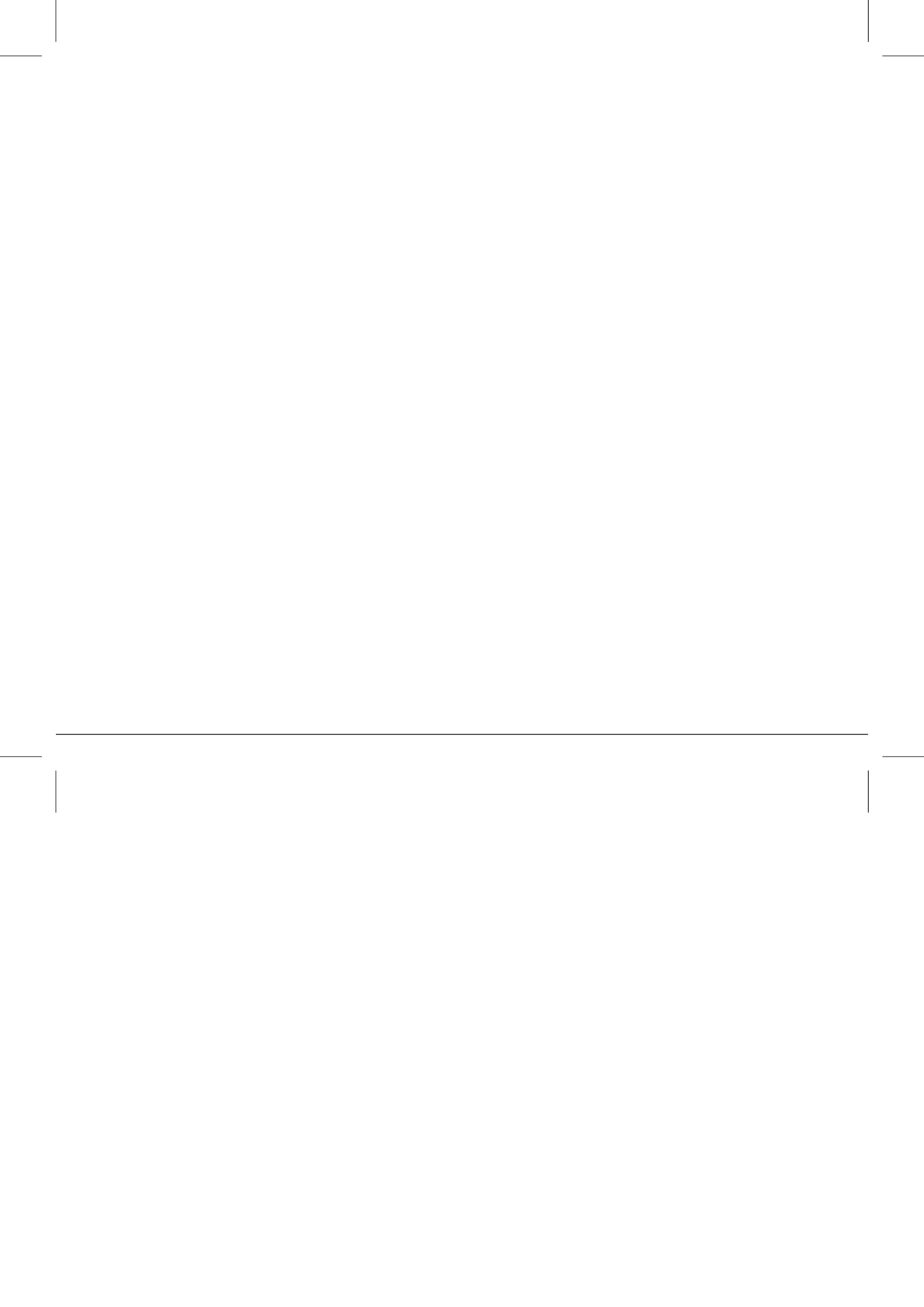



vided free of charge. Copies allowed for personal use only. Not for commercial use.