

AP Godai - SECTION

Design & Drawing by: Tony Roehling

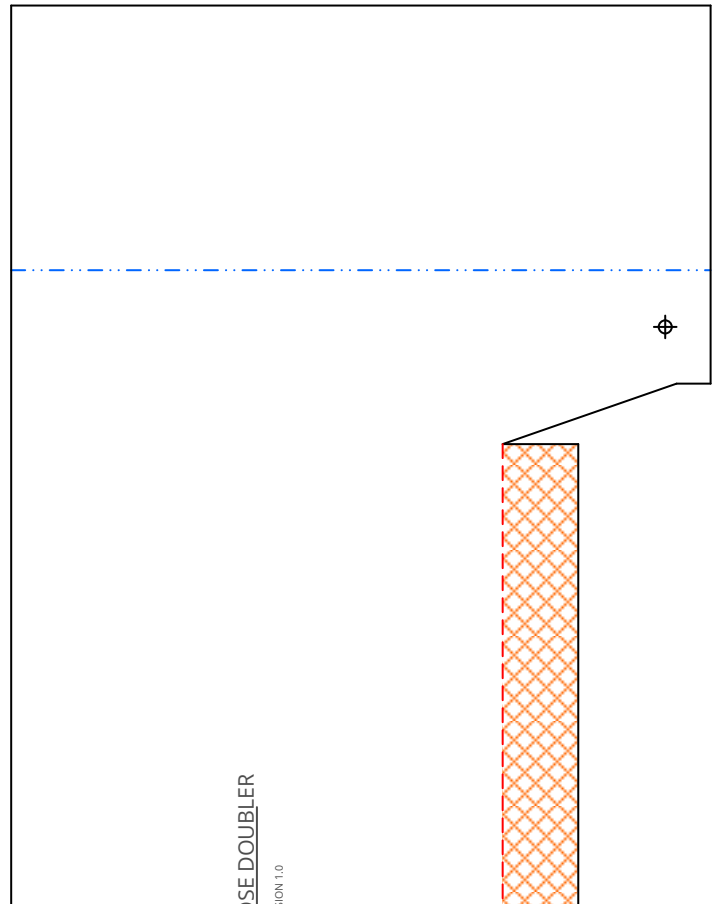

USE DOUBLER
SIGN 1.0

NA - FUSELAGE - VERSION 1.0 (2017-0)

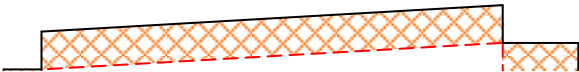
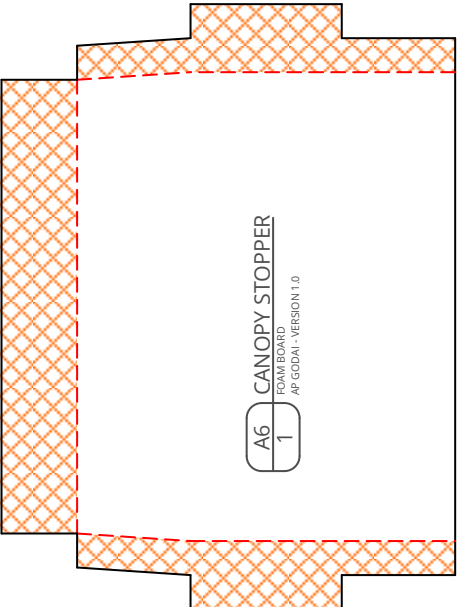

8-18)

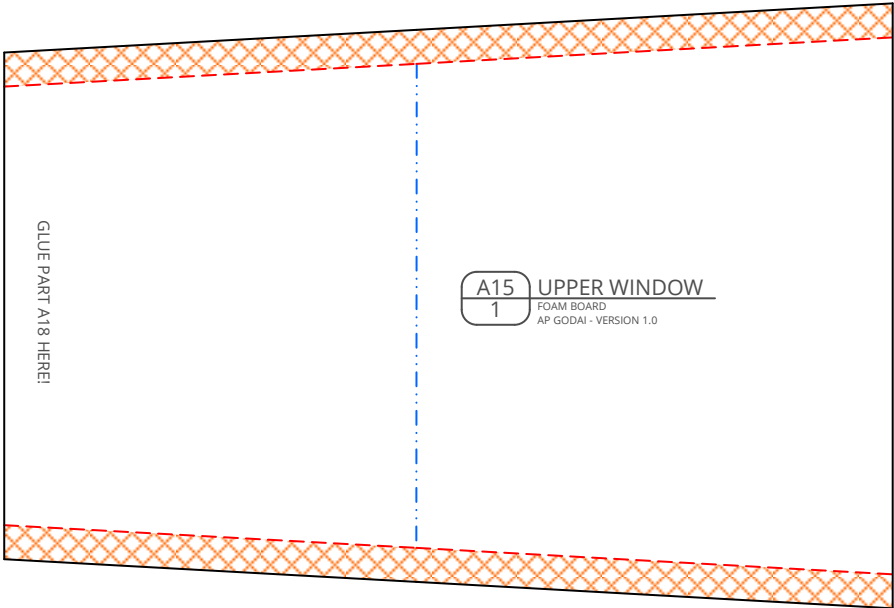

in

cm

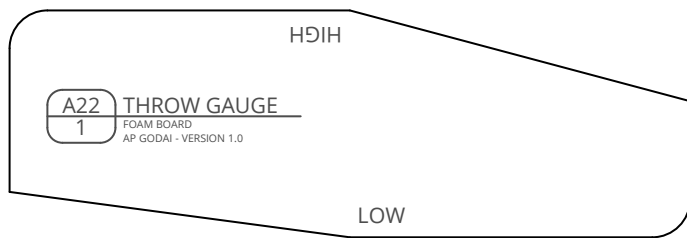



SECTION A - SHEET 1 OF 2

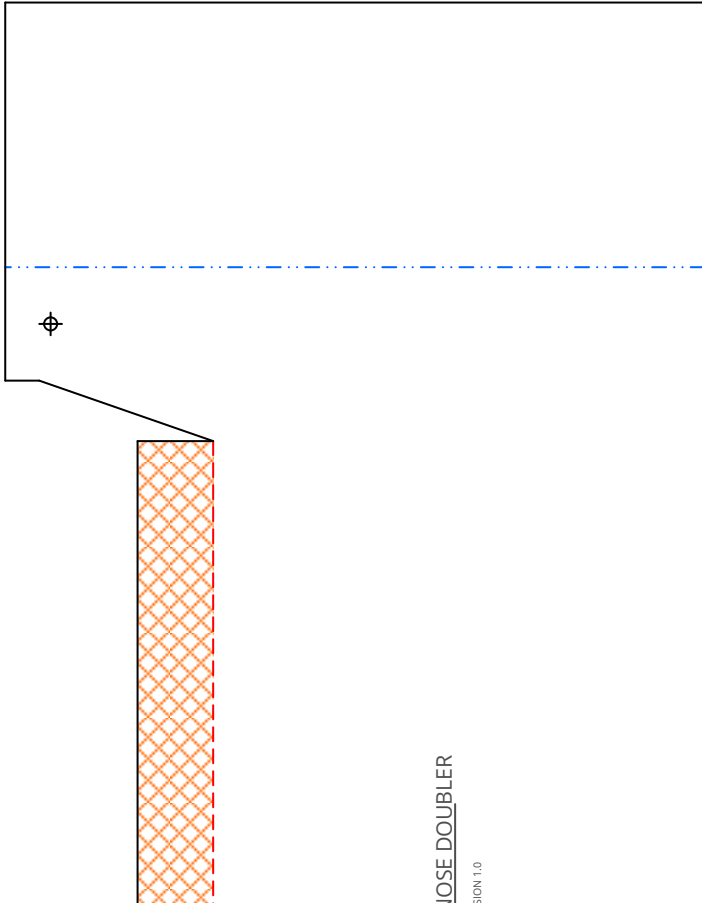

JOSE DOUBLER
SIGN 1.0

A5 LEFT NC
FOAM BOARD
1
AP-GCDAI - VER

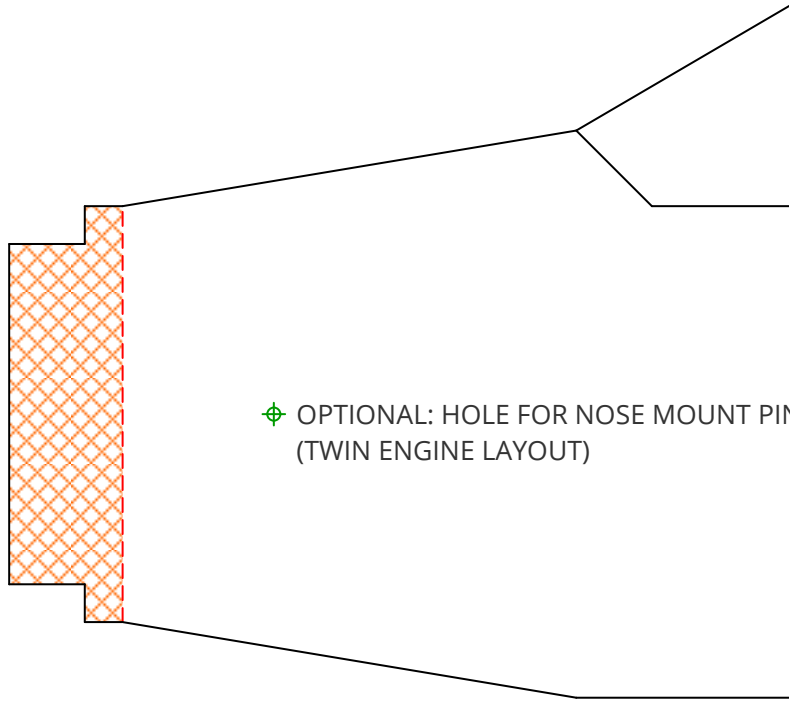
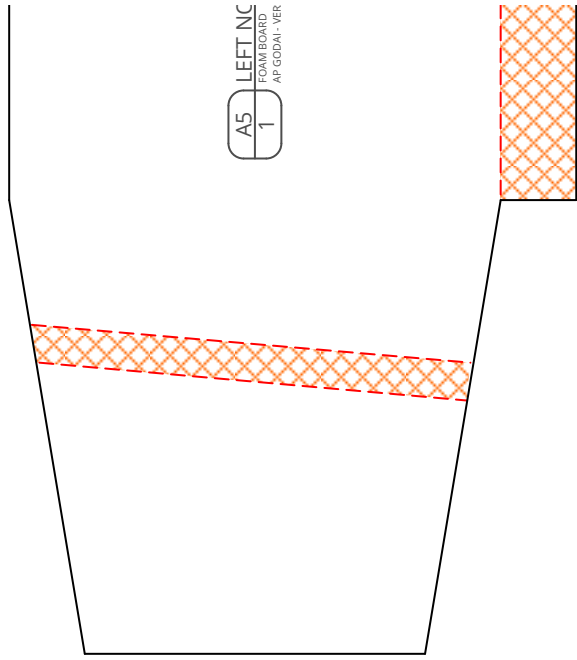

OPTIONAL: HOLE FOR NOSE MOUNT PIN
(TWIN ENGINE LAYOUT)

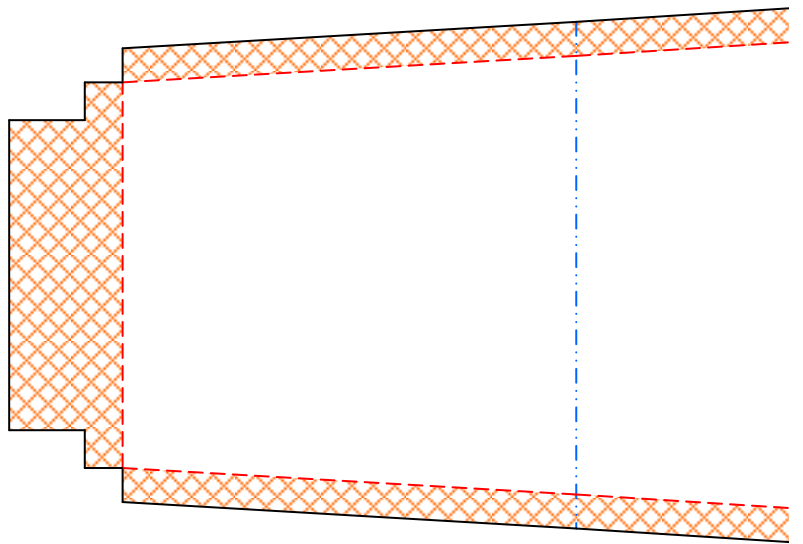

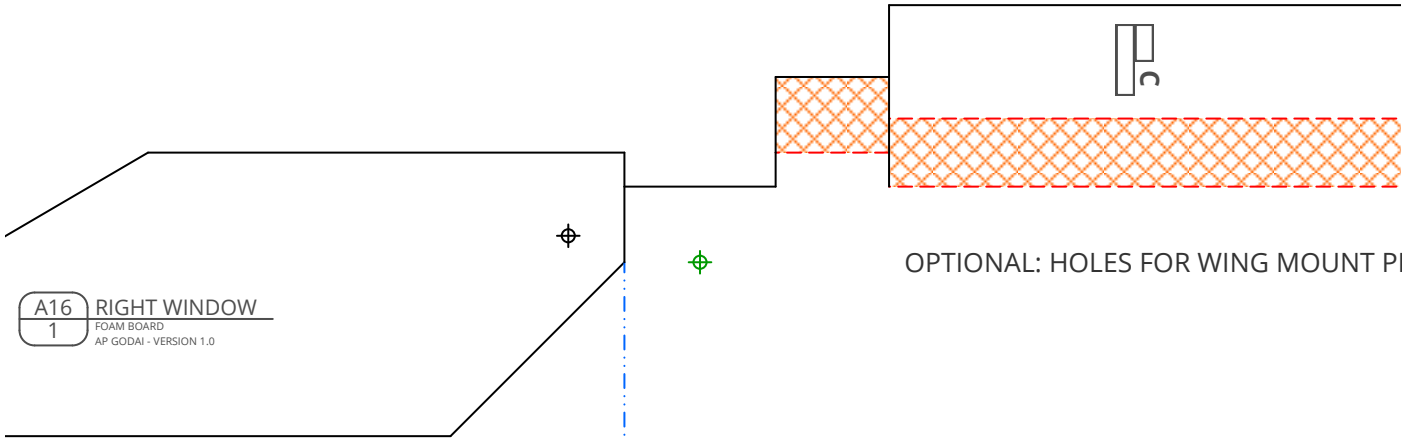
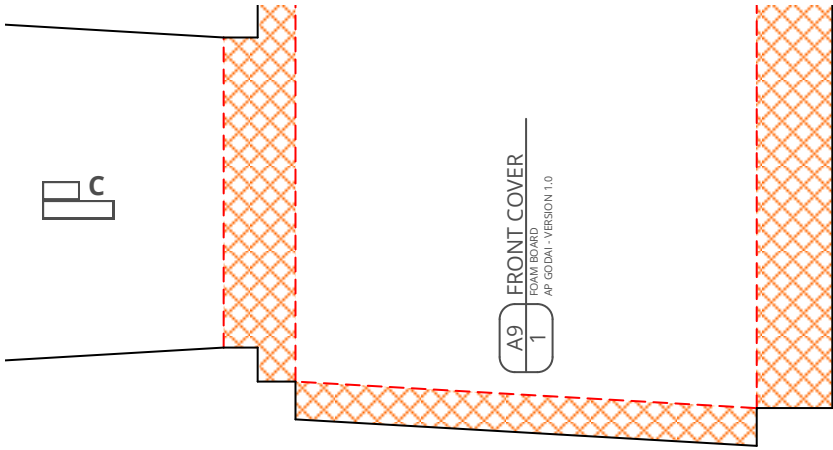

∇

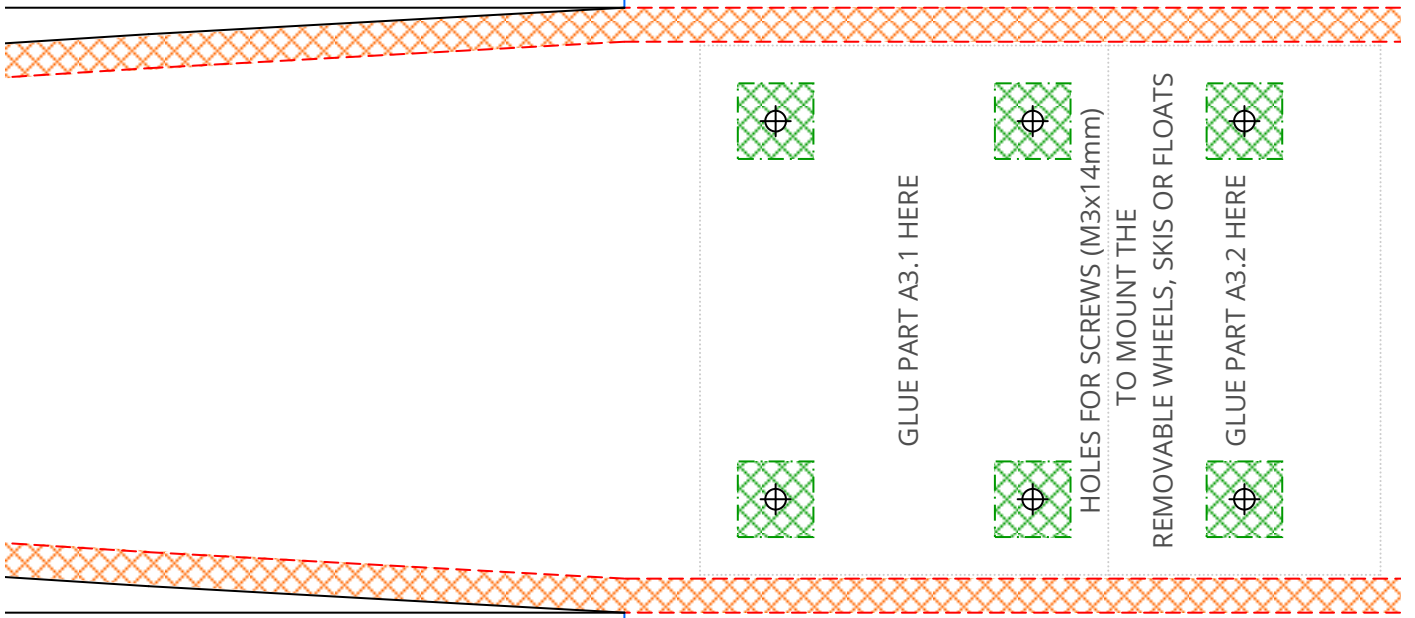

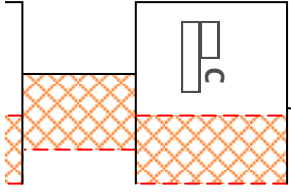
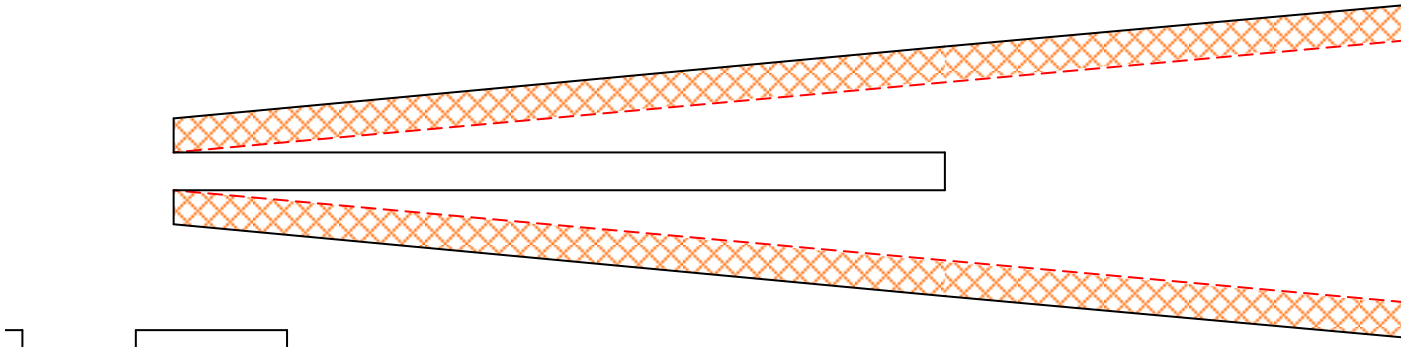

INS

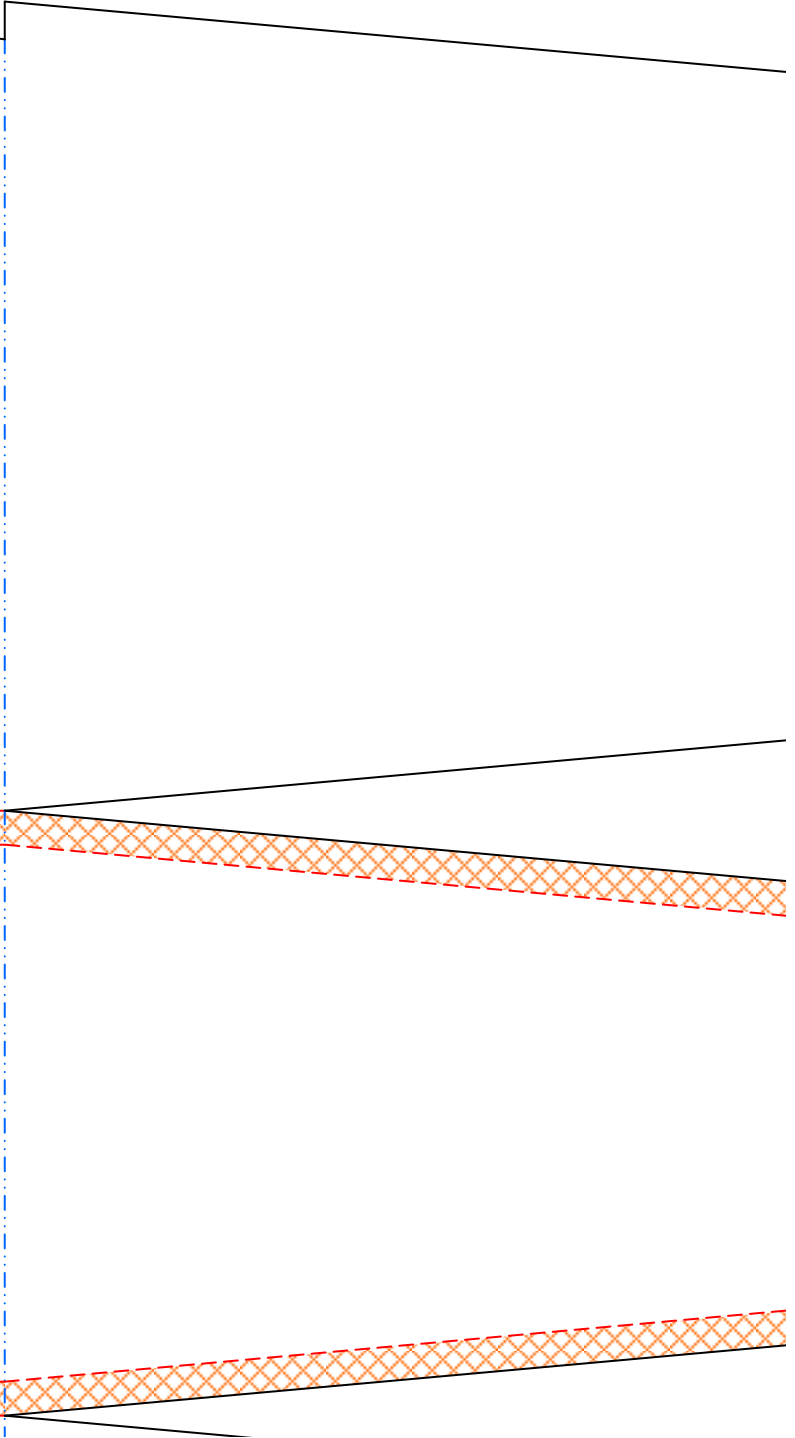

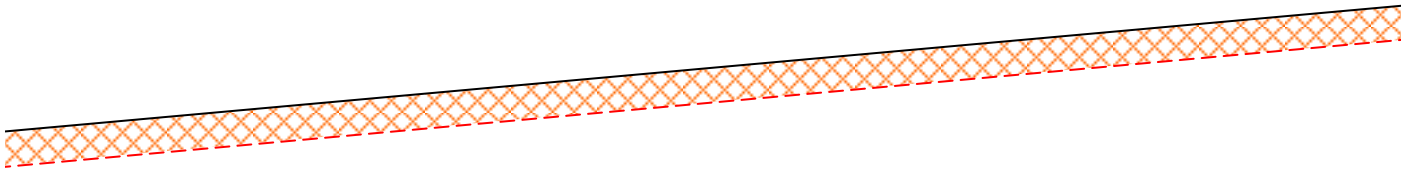

A14 REAR COVER
1 FOAM BOARD
AP GODAJ - VERSION 1.0

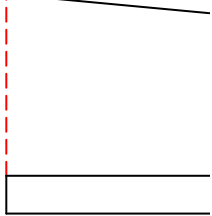
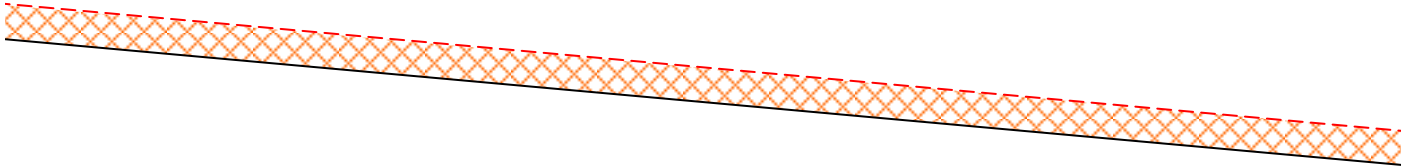

HOLE FOR
RUDDER SERVO

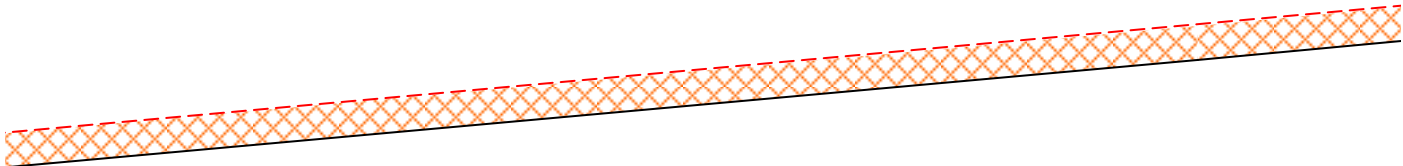
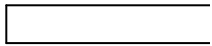
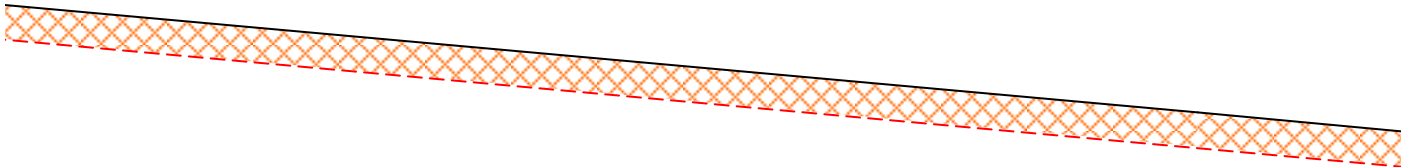
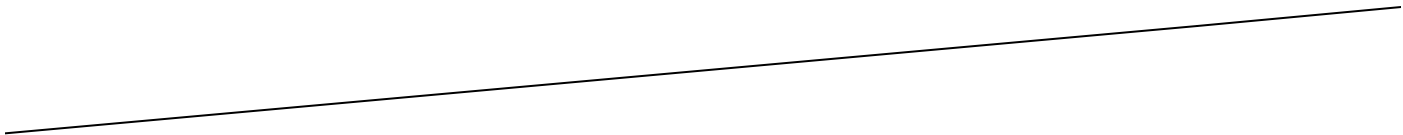

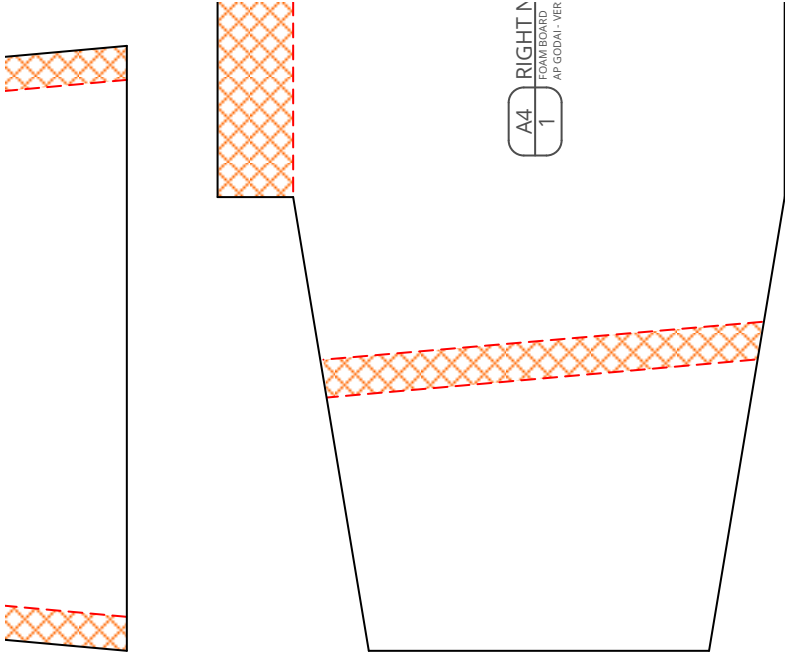

A4 RIGHT N
FOAM BOARD
1
AP.GGDAL-VER

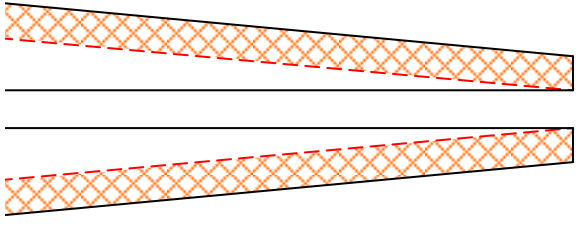
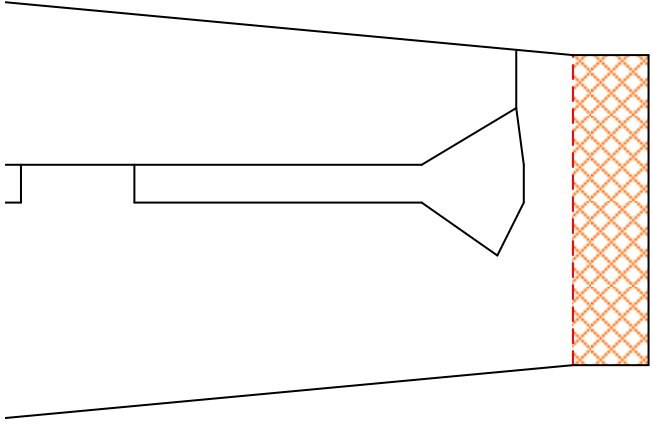

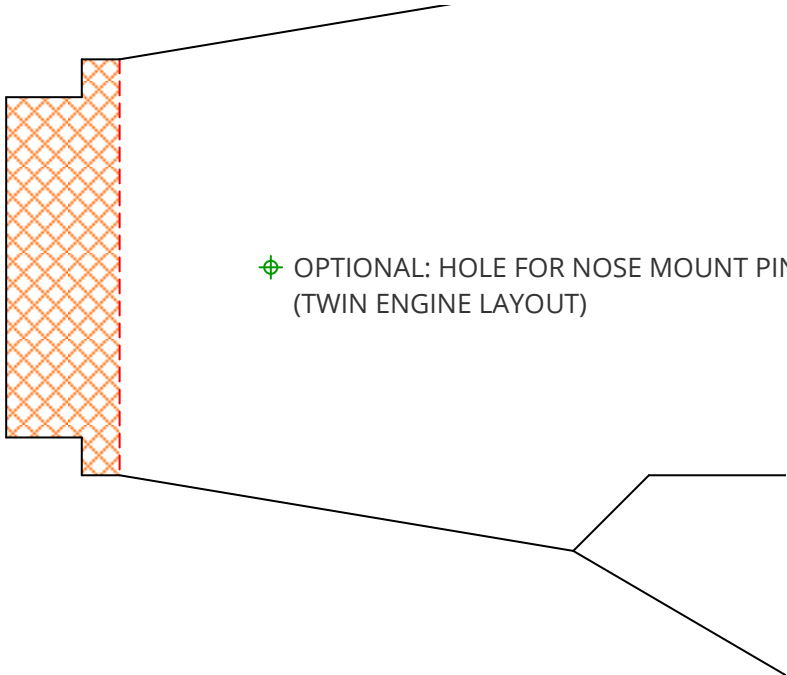

OPTIONAL: HOLE FOR NOSE MOUNT PIN
(TWIN ENGINE LAYOUT)



v

A17 LEFT WINDOW
1 FOAM BOARD
AP GODAI - VERSION 1.0



OPTIONAL: HOLES FOR WING MOUNT PI

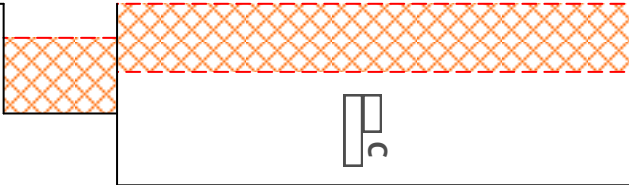

INS

ϕ

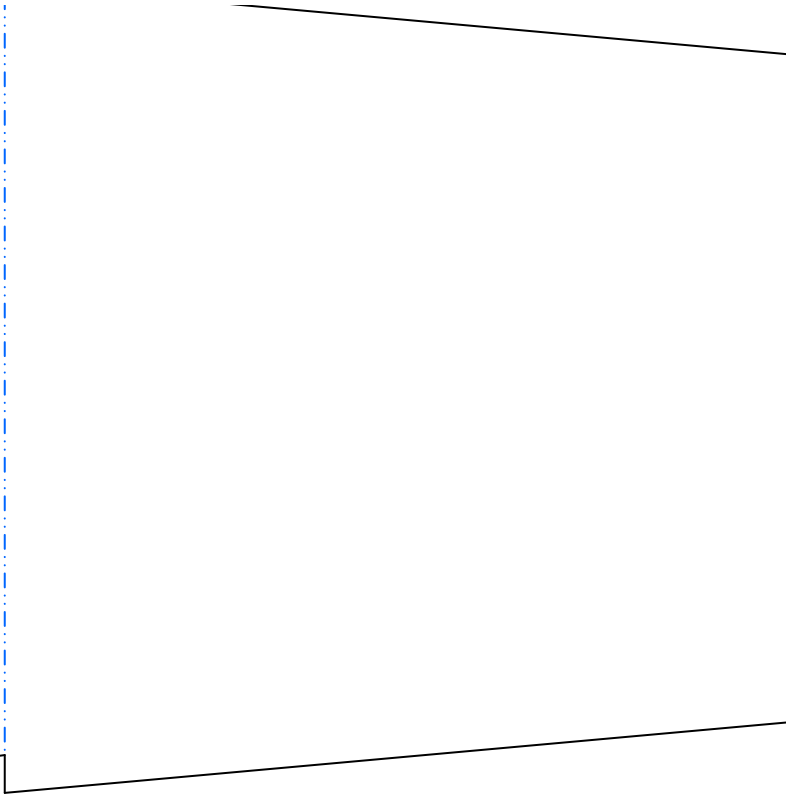
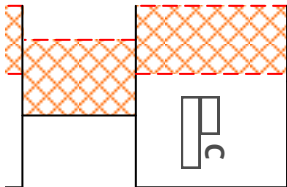

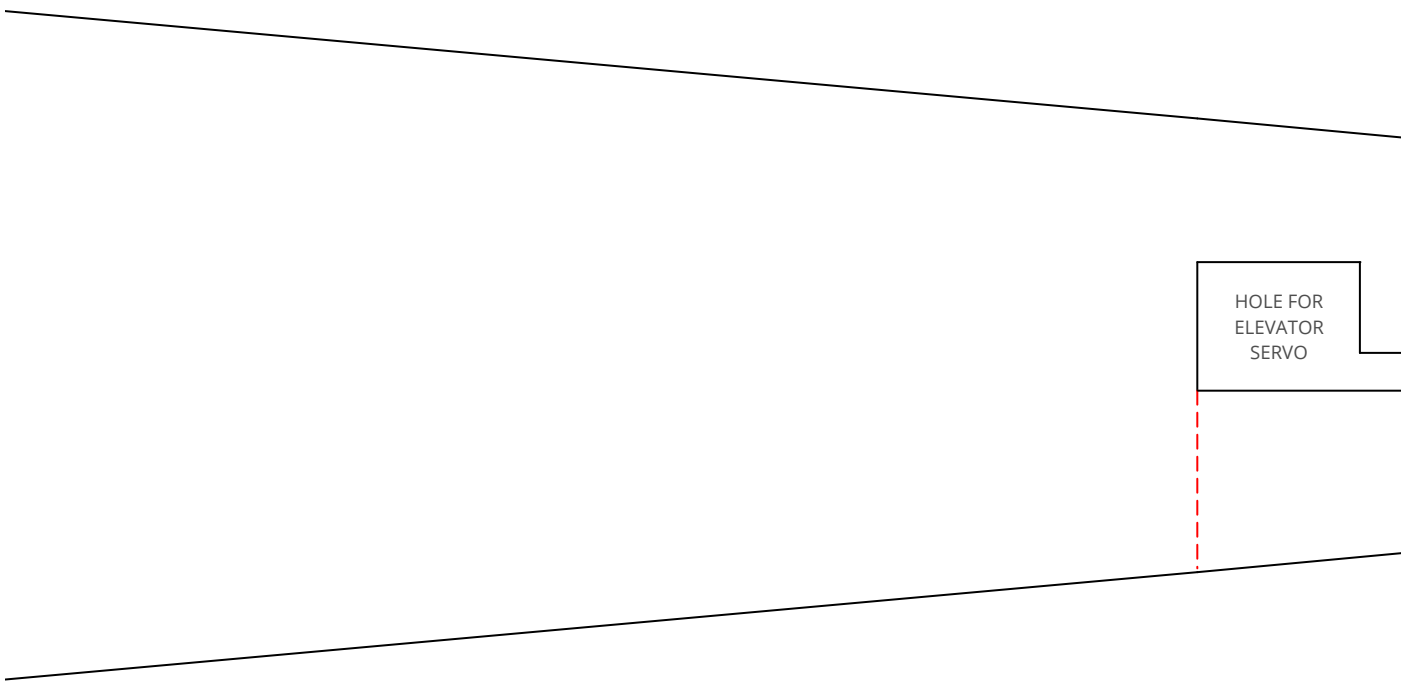

HOLE FOR
ELEVATOR
SERVO

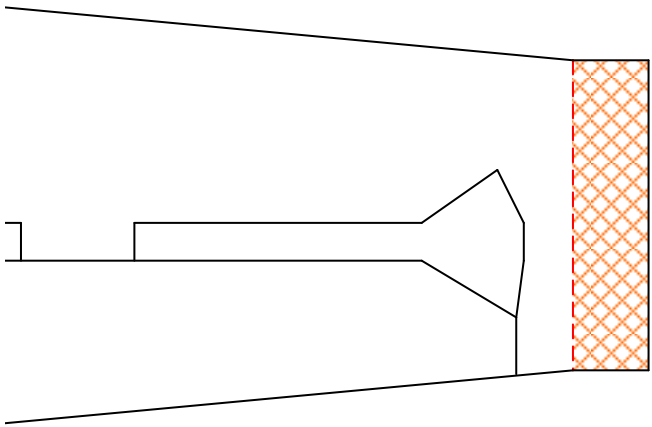

vided free of charge. Copies allowed for personal use only. Not for commercial use.

AP Godai - SECTION

Design & Drawing by: Tony Roehling

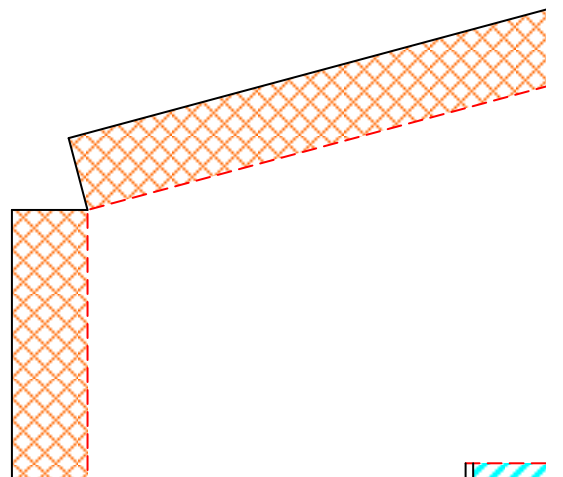

NA - FUSELAGE - VERSION 1.0 (2017-0)

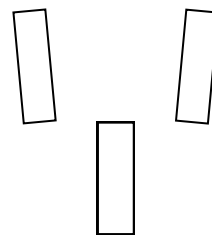
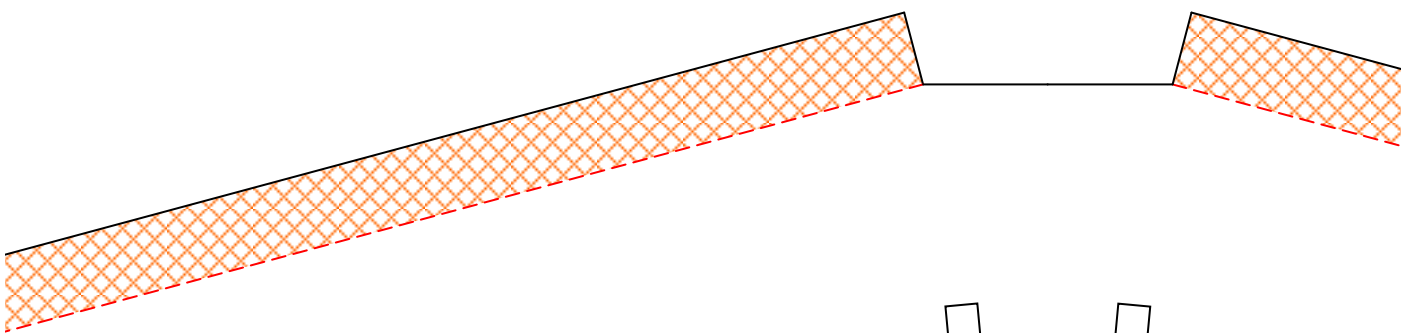

A10 HORIZONTAL STABILIZER
1 FOAM BOARD
AP GODAI - VERSION 1.0

8-18)

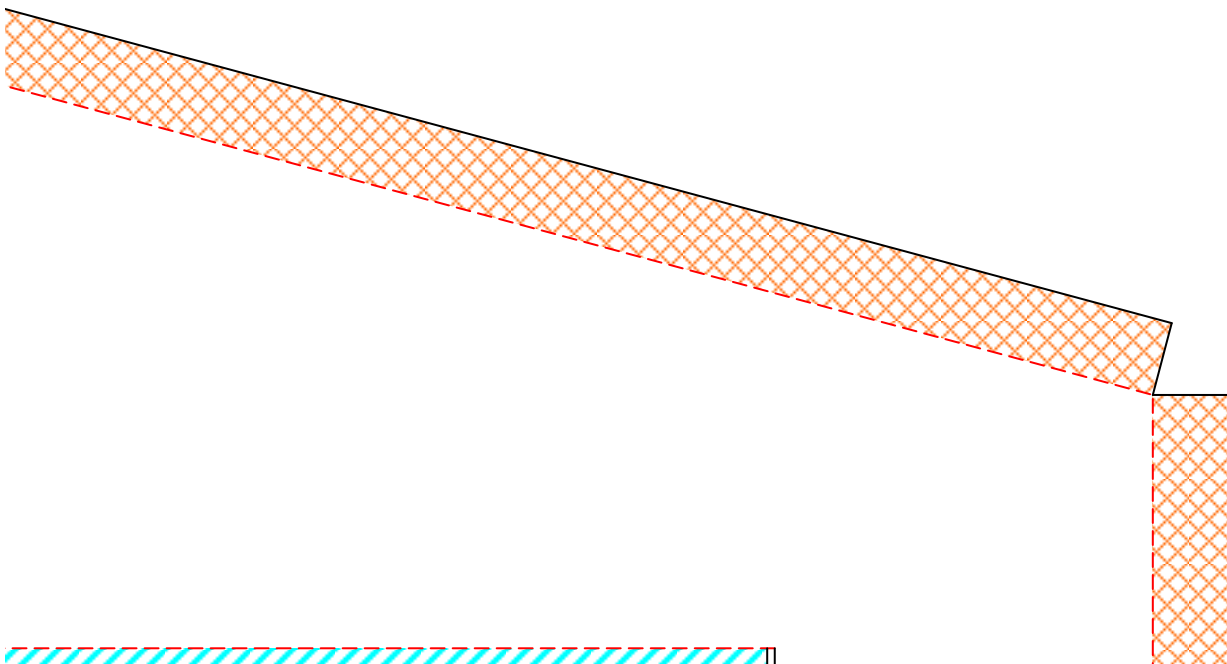

in
cm

PARTS MADE OF PLASTIC CARD

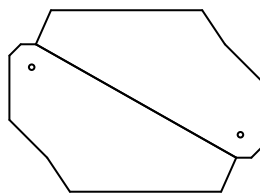

A20 CONTROL HORN (RUDDER & ELEVATOR)
2 PLASTIC CARD
AP GODAI - VERSION 1.0

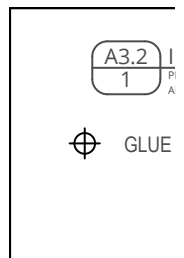
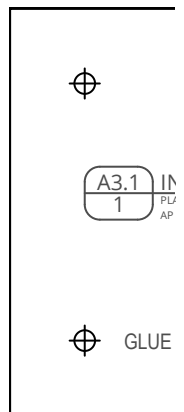

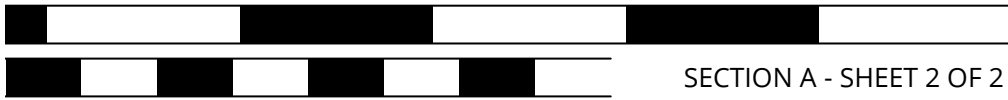

SECTION A - SHEET 2 OF 2



INNER GEAR MOUNT

LASTIC CARD
P.GODAI - VERSION 1.0

NUTS (M3) OVER THE HOLES 

INNER GEAR MOUNT (+FLOATS)

LASTIC CARD
P.GODAI - VERSION 1.0

NUTS (M3) OVER THE HOLES 

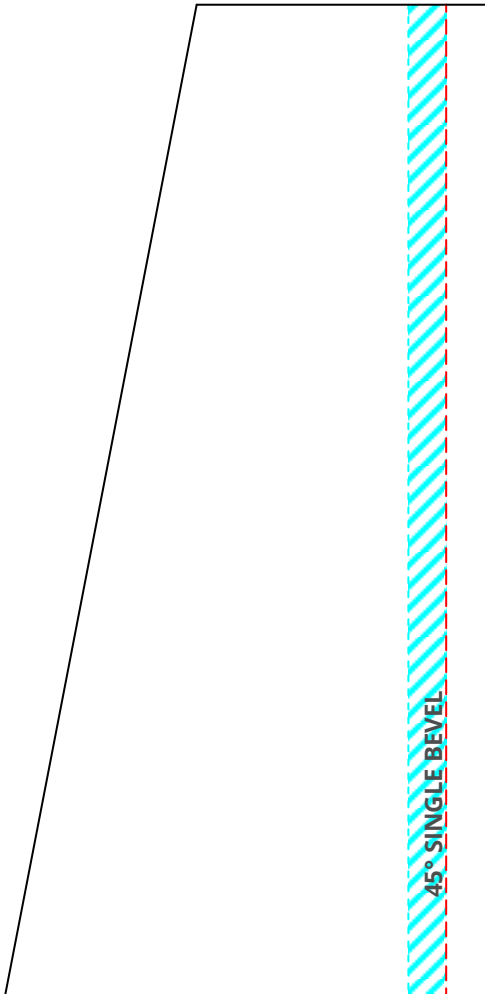



GLUE IN PART A11 HERE

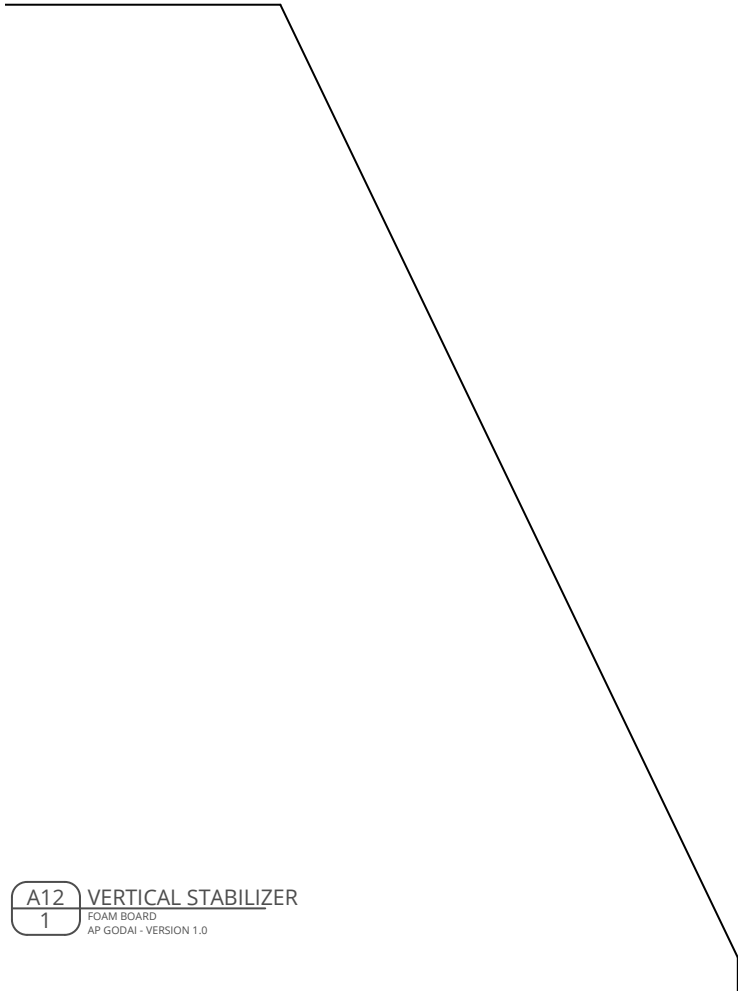



PARTS MADE OF PLYWOOD (max. 5mm | 0.19in)

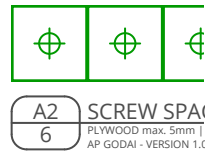
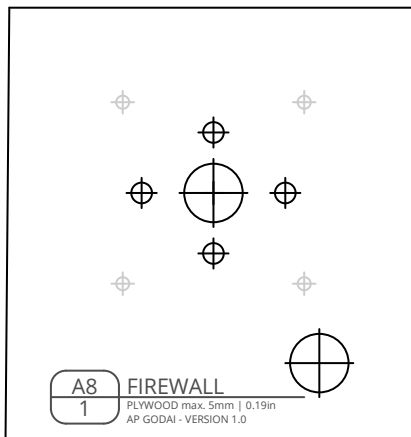

PARTS MADE OF BBQ SKEWERS



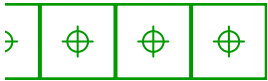

CER (OPTIONAL)
0.19in
)



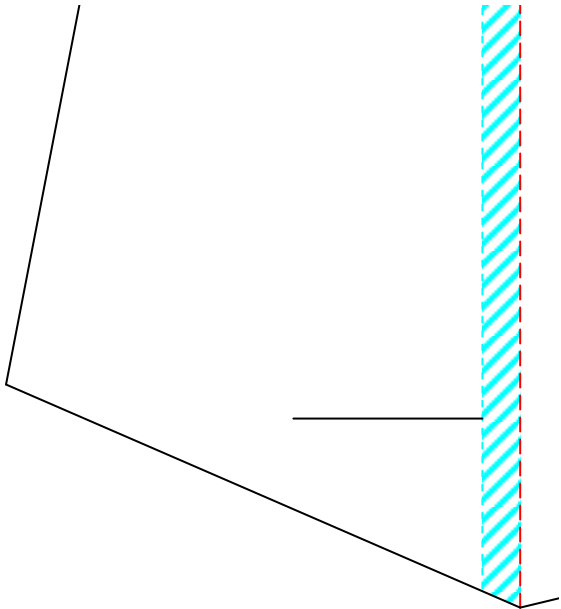

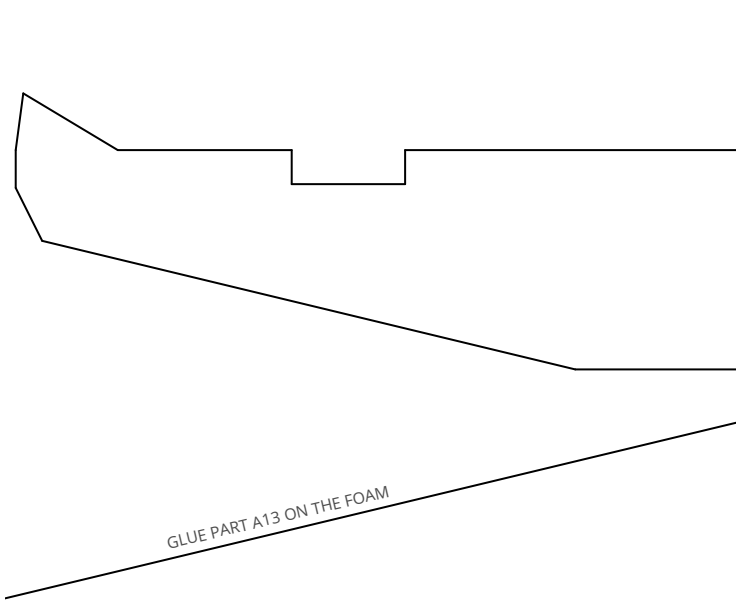

GLUE PART A13 ON THE FOAM

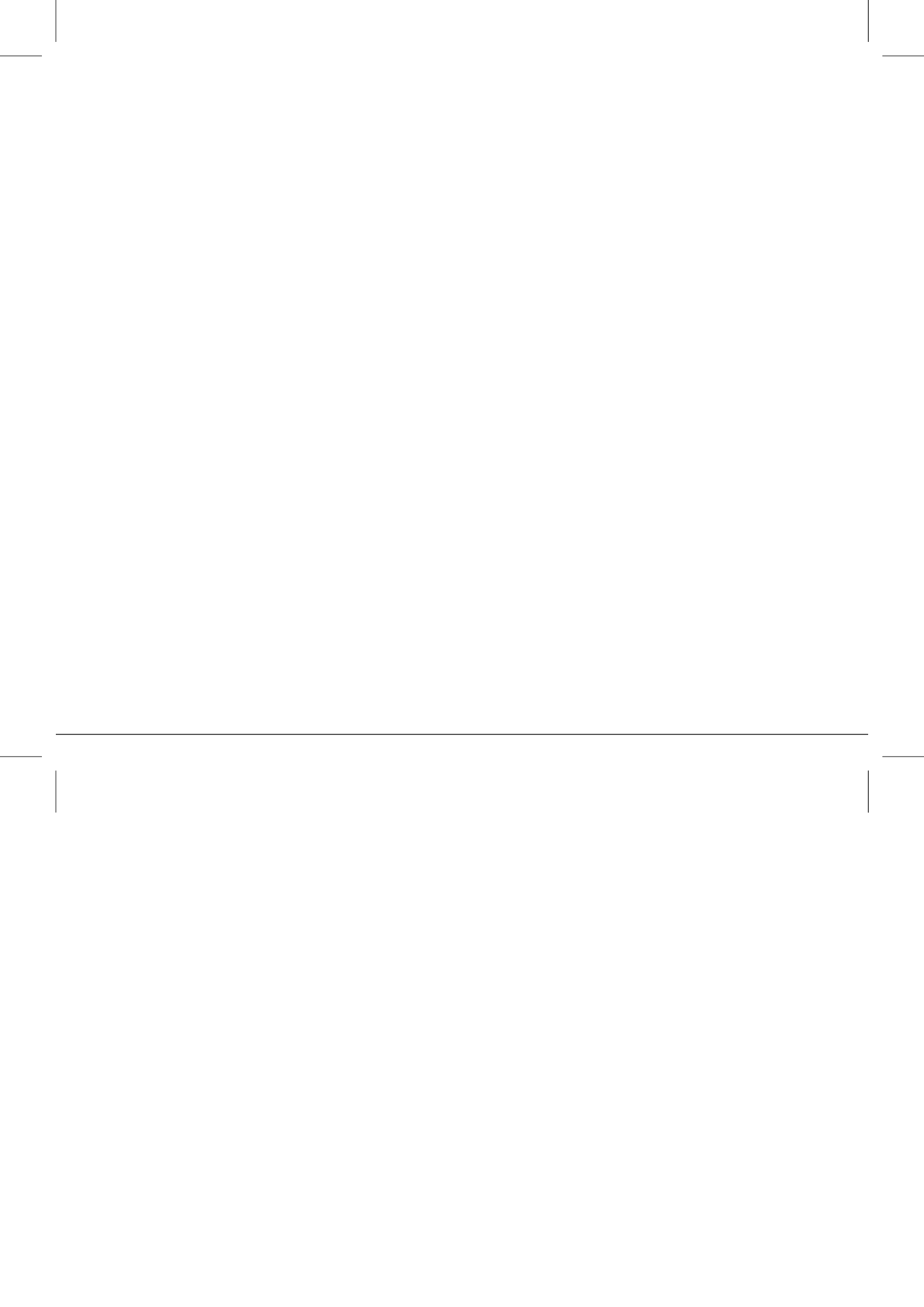



A19 CANOPY CLOSER
1 BBQ SKEWER
AP GODAI - VERSION 1.0



A21 WING MOUNT PIN (OPTIONAL)
2 BBQ SKEWER
AP GODAI - VERSION 1.0



A21 WING MOUNT PIN (OPTIONAL)
2 BBQ SKEWER
AP GODAI - VERSION 1.0

vided free of charge. Copies allowed for personal use only. Not for commercial use.