



airc-pirates.com

AP Kwak

... the Mighty Mini Foam Board Mod of the Jupiter Duck

Version 1.0 (2017-01-28)

Drawing by: Tony Roehling

Special thanks to Thomas Buchwald for the Depron Jupiter Duck Design



SPECS

WINGSPAN: 650 mm | 25.59 in
CG: 50 mm | 1.97 in
LENGTH: 590 mm | 23.23 in
DRY WEIGHT: 180 g | 6.35 oz
ALL UP WEIGHT: 315 g | 11.11 oz WITH 3S 850 mAh
EXPO: 35 %
CHANNELS: 3 (THR | ELV | RUD)

ELECTRONICS

MOTOR: 1 x 2300 kv (2204 or 1806)
PROPELLER: 1 x 6x4
ESC: 1 x 12 A
SERVOS: 2 x 5 g
BATTERY: 850 mAh 3S



DRAWING KEY

based on the Flite Test Drawing Key, which was created by Dan Sponholz

FOLD TYPES

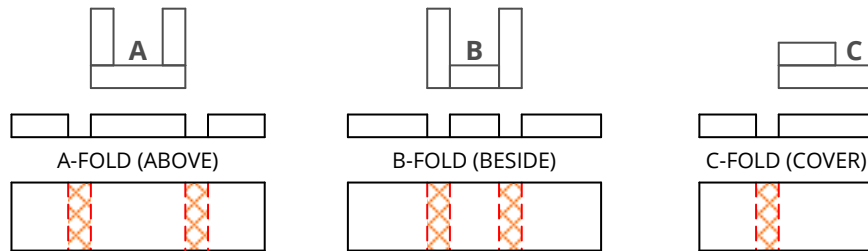

LINE TYPE/COLOR

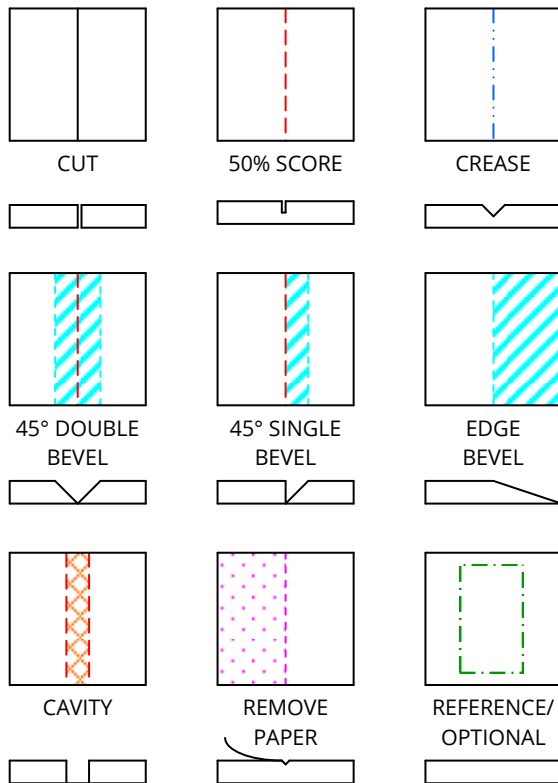

SYMBOLS

PART NUMBER

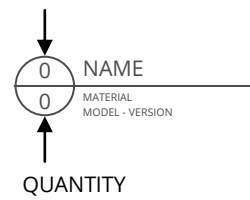

AP Kwak - PARTS LIST

PART NR.	DESCRIPTION	QUANTITY	MATERIAL	SHEET
01	VERTICAL SPACER	1	FOAM BOARD	1
02	BATTERY/ELECTRONICS TRAY	1	FOAM BOARD	1
03	RIGHT SIDE WALL	1	FOAM BOARD	1
04	LEFT SIDE WALL	1	FOAM BOARD	1
05	FRONT SHEETING	1	FOAM BOARD	1
06	HATCH SUPPORT	1	FOAM BOARD	1
07	REAR BOTTOM SHEETING	1	FOAM BOARD	1
08	REAR TOP SHEETING	1	FOAM BOARD	1
09	HORIZONTAL STABILIZER	1	FOAM BOARD	1
10	VERTICAL STABILIZER	1	FOAM BOARD	1
11	HORIZONTAL STABILIZER SUPPORT	2	BBQ SKEWER	1
12	CONTROL HORN (ELEVATOR & RUDDER)	2	PLASTIC CARD	1
13	FRONT WINDSHIELD	1	FOAM BOARD	1
14	FRONT WINDSHIELD HOLDER	2	FOAM BOARD	1
15	FRONT WINDSHIELD PIN	1	BBQ SKEWER	1
16	REAR WINDSHIELD	1	FOAM BOARD	1
17	WING	1	FOAM BOARD	2
18	WING SPAR	1	FOAM BOARD	2
19	POWER POD NACELLE	1	FOAM BOARD	2
20	POWER POD PIN	2	BBQ SKEWER	2
21	PONTOON	2	FOAM BOARD	2
22	RIGHT PONTOON PYLON	1	FOAM BOARD	2
23	LEFT PONTOON PYLON	1	FOAM BOARD	2
24	PONTOON PYLON SUPPORT	2	BBQ SKEWER	2
25	MINI POWER POD	1	FOAM BOARD	1
26	FIREWALL	1	PLYWOOD max. 5mm	1
27	THROW GAGE	1	FOAM BOARD	1
	OTHER MATERIALS			
	STEEL WIRE (Ø 1mm) FOR THE LINKAGE RODS			
	VELCRO TO MOUNT THE BATTERY, ESC, ...			

Build the Kwak in the order of the part numbers!

AP Kwak

... the Mighty Mini Foam Board Mod of the Jupiter Duck

Drawing by: Tony Roehling

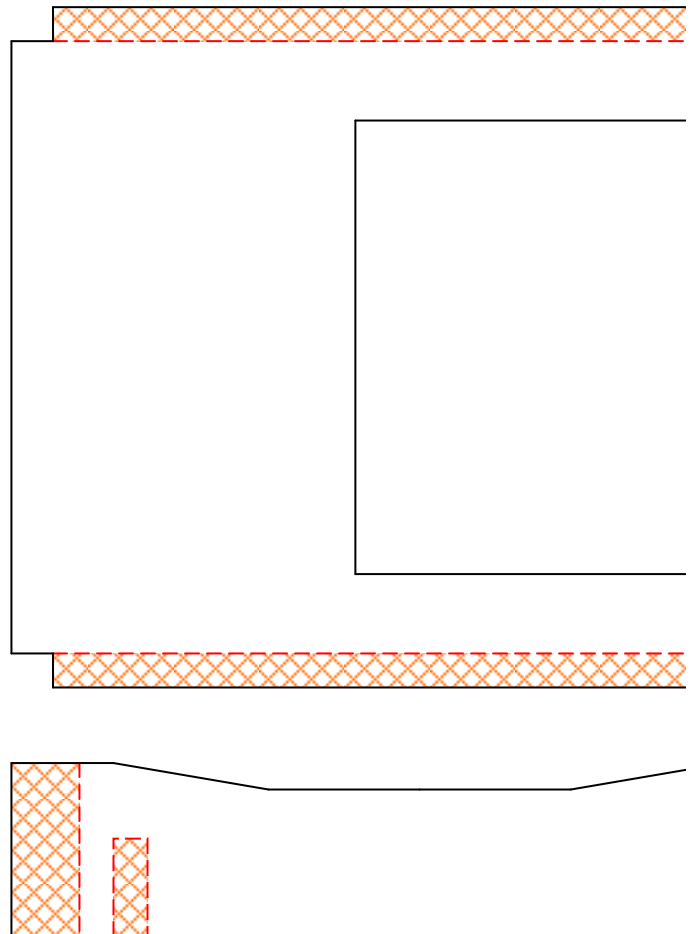



45° DOUBLE BEVEL

05 FRONT SHEETING
1

FOAM BOARD
AP KWAK - VERSION 1.0

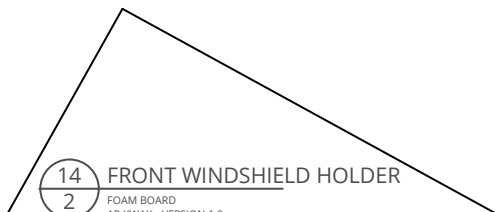
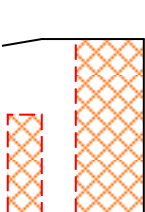

14 FRONT WINDSHIELD HOLDER
2

FOAM BOARD
AP KWAK - VERSION 1.0



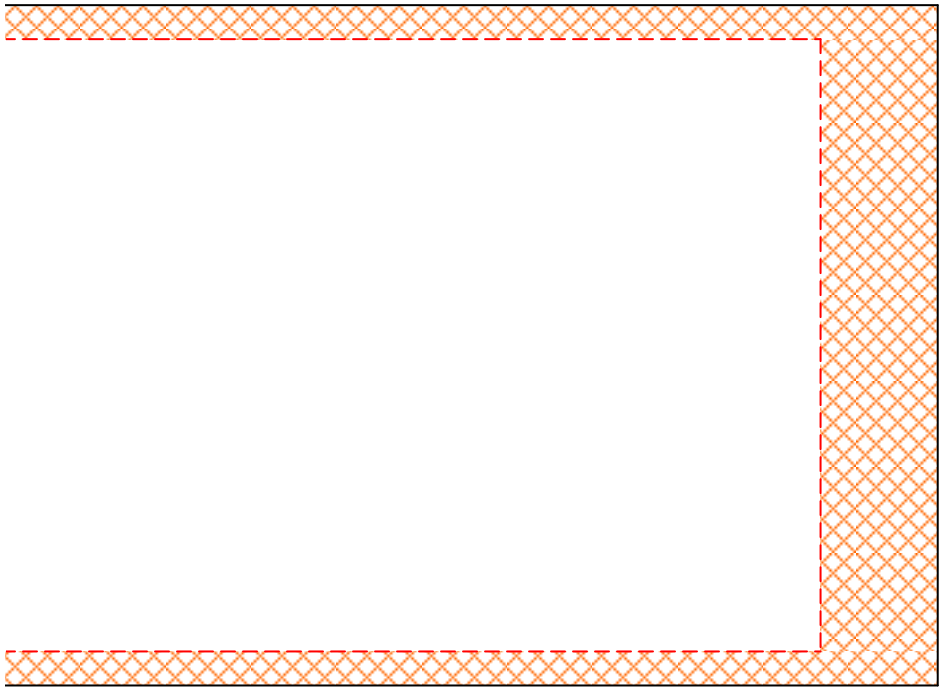

07 REAR BOTTOM S
1 FOAM BOARD
AP KWAK - VERSION 1.0

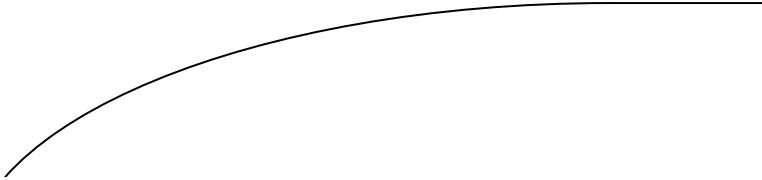

in
cm



HEETING



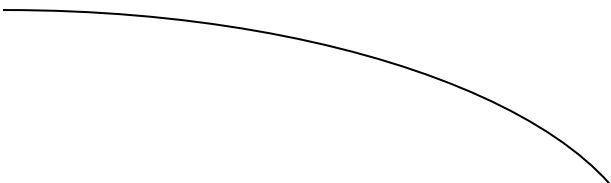
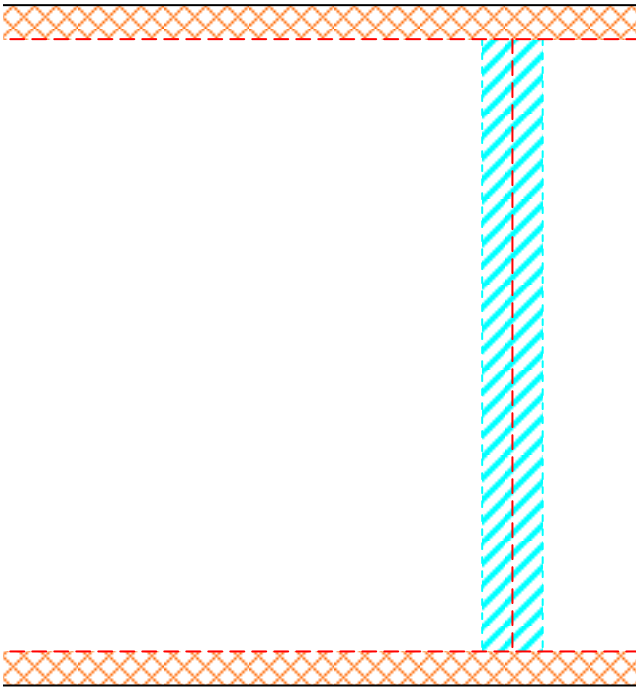

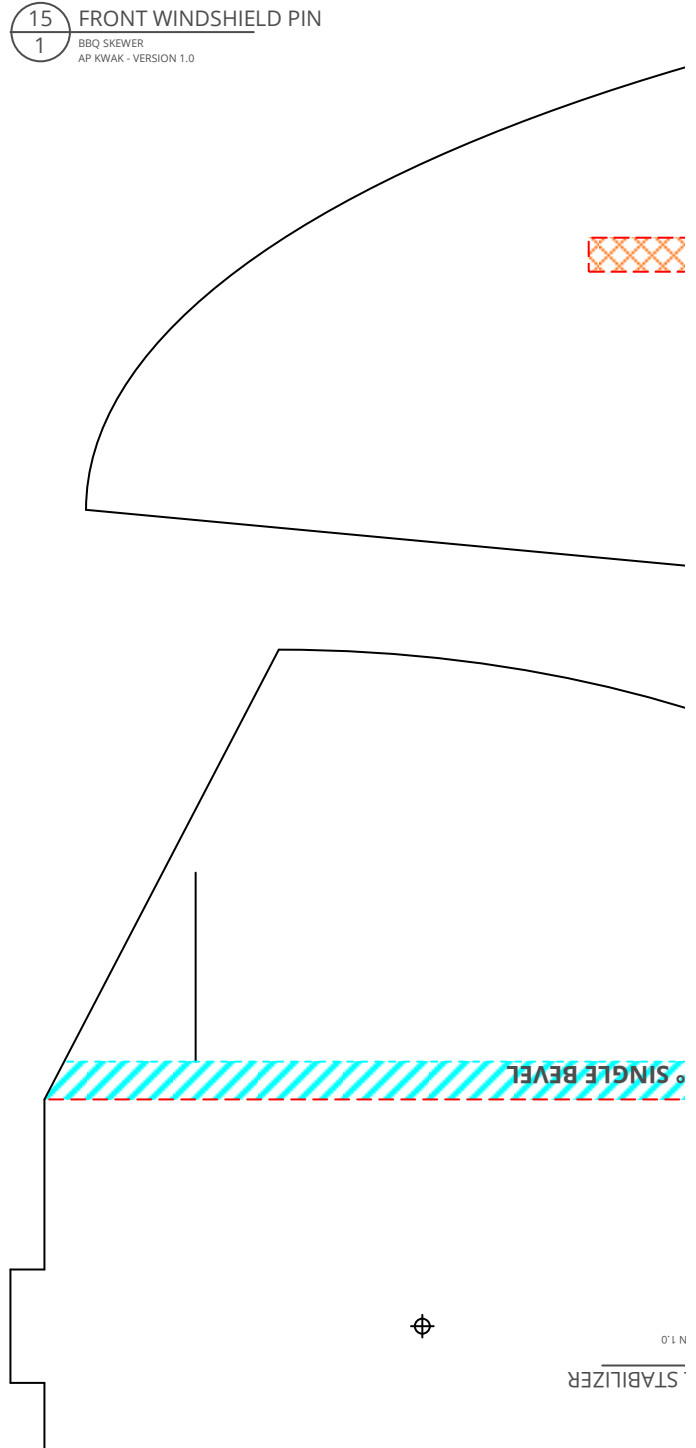
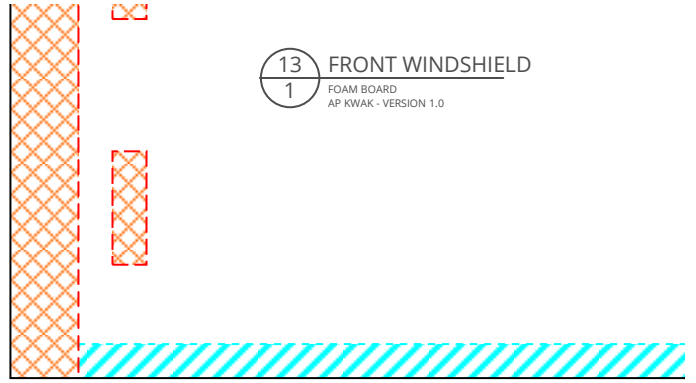

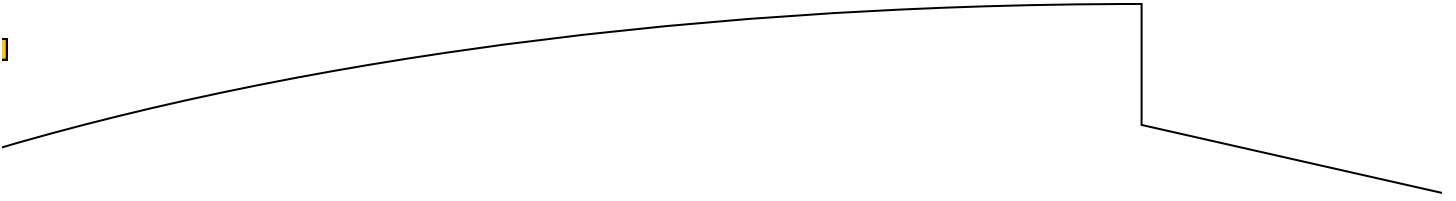
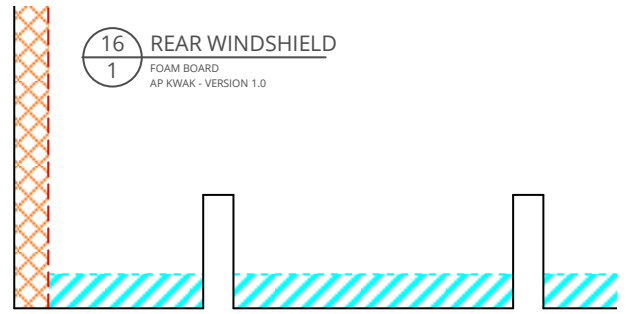
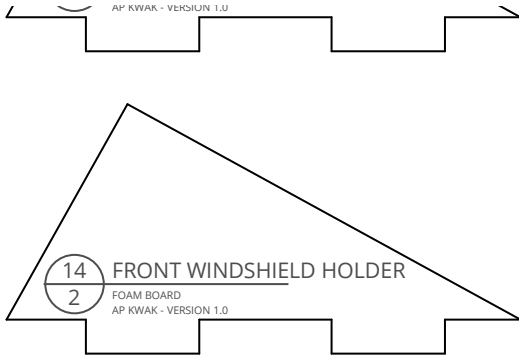
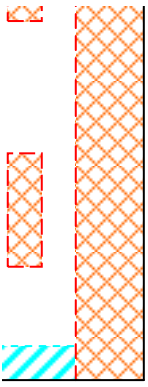

04 LEFT SIDE WALL
FOAM BOARD
AP KWAK - VERSION 1.0

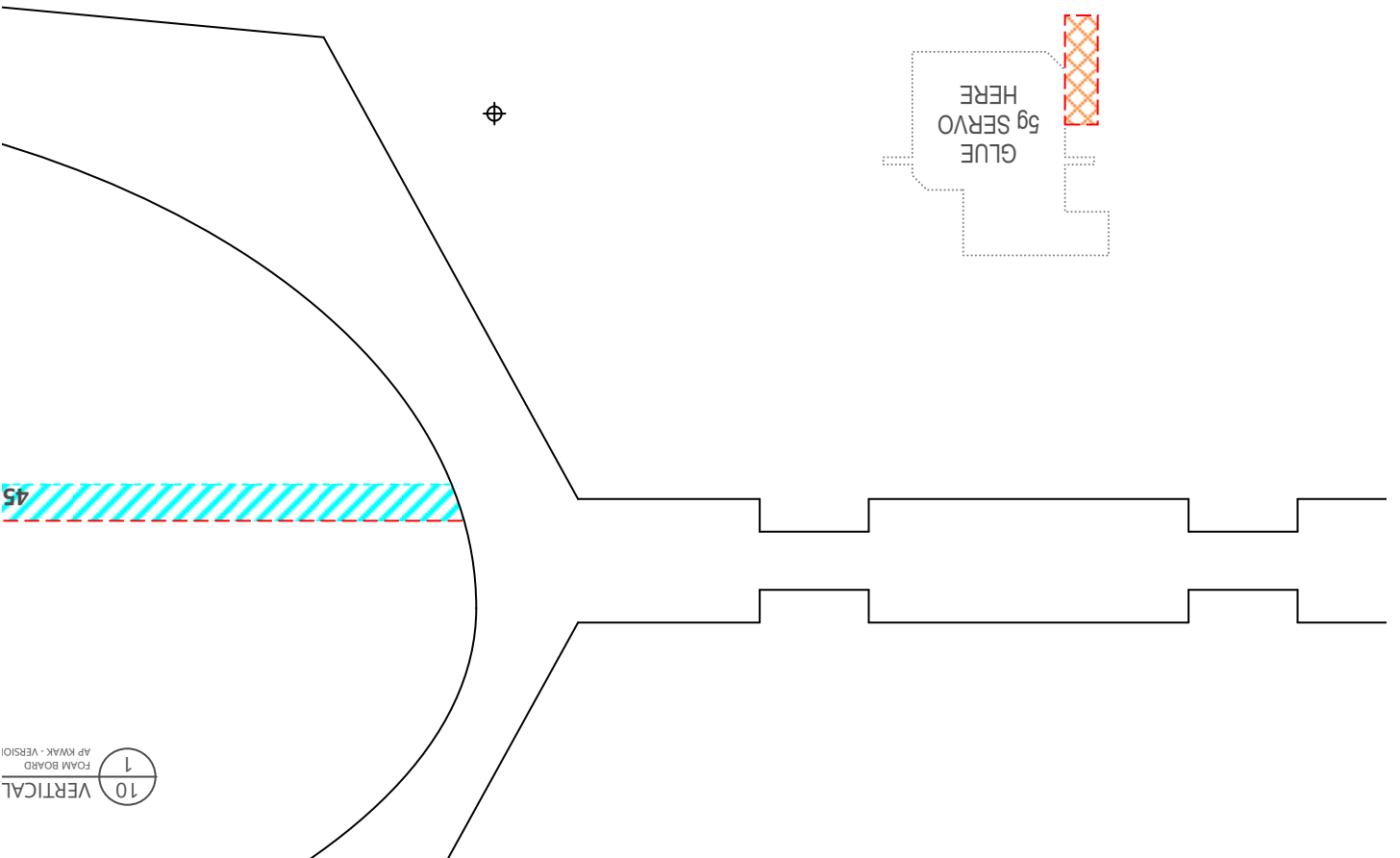

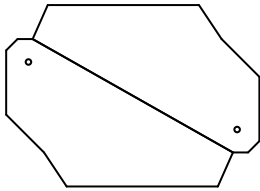

12 CONTROL HORN
2 PLASTIC CARD
AP KWAK - VERSION 1.0

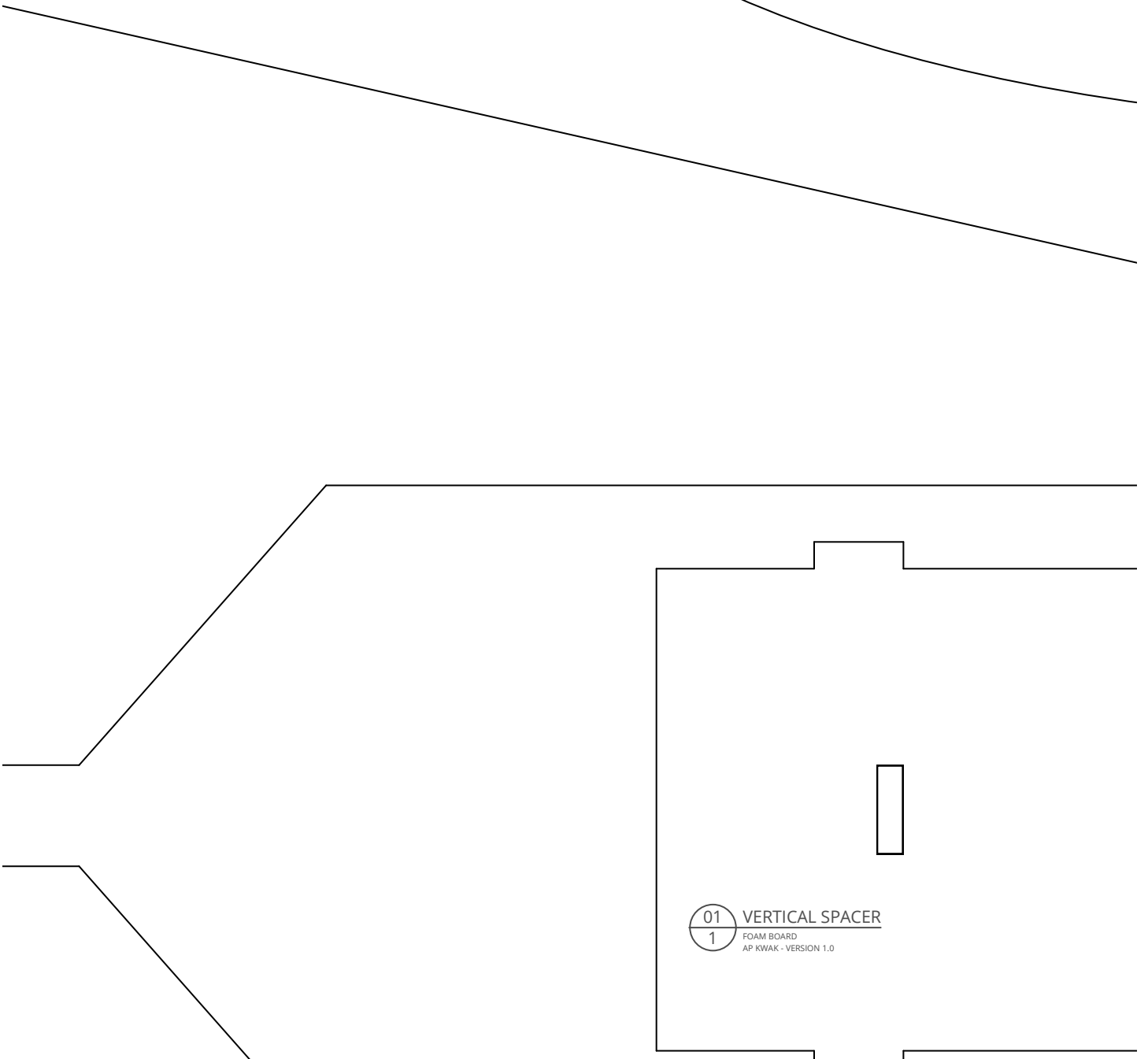
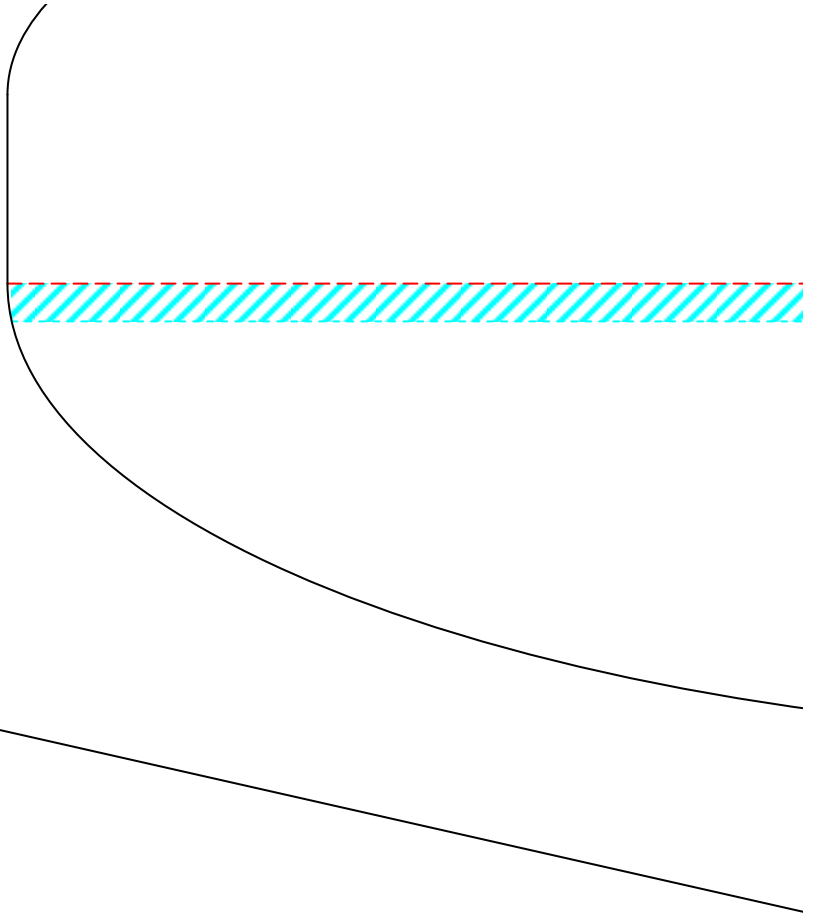

01 VERTICAL SPACER
1 FOAM BOARD
AP KWAK - VERSION 1.0



09
1

HORIZONTAL STABILIZER

FOAM BOARD
AP KWAK - VERSION 1.0



45° SINGLE BEVEL

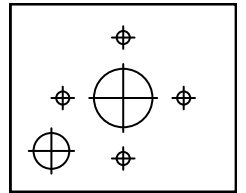
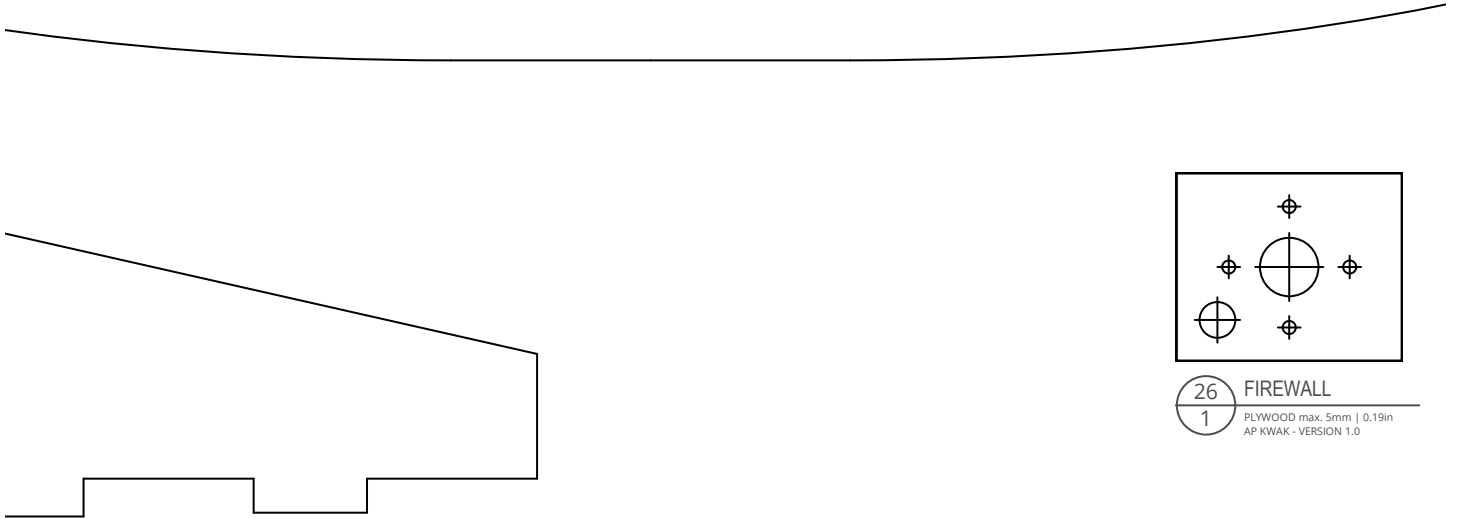

26
1

FIREWALL

PLYWOOD max. 5mm | 0.19in
AP KWAK - VERSION 1.0

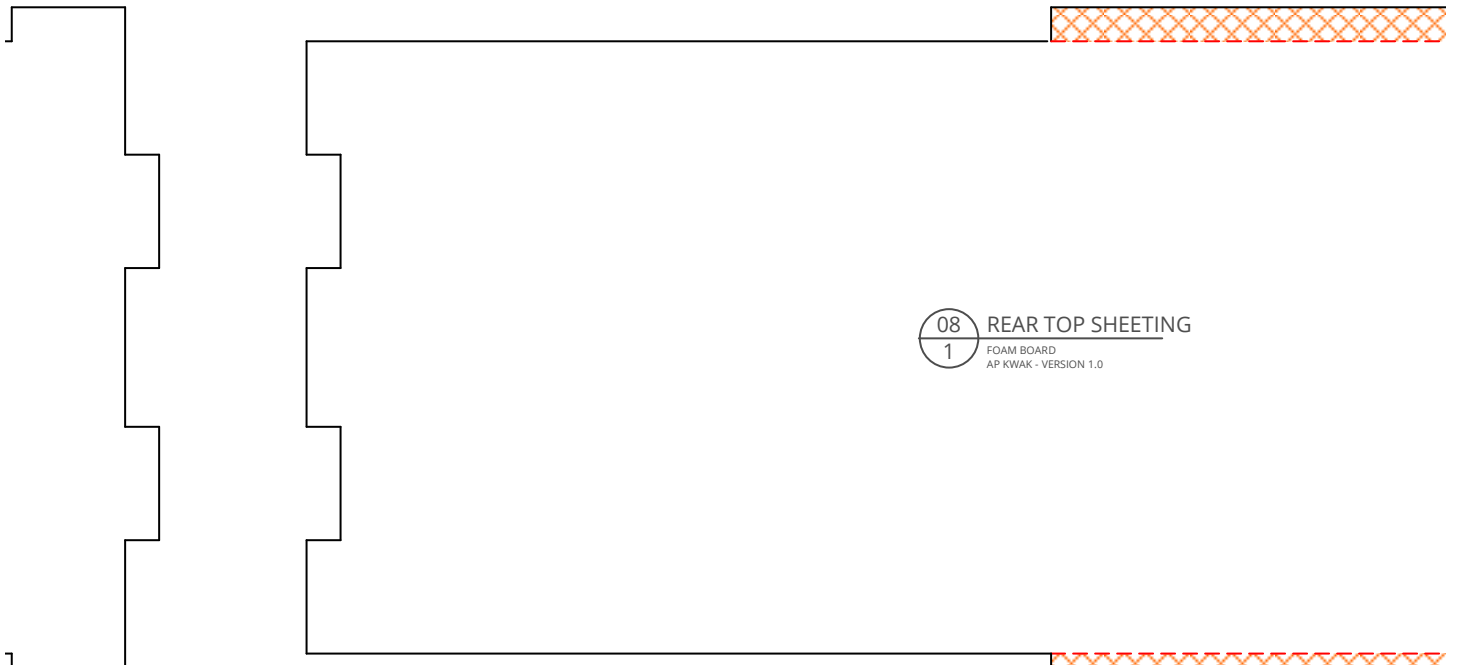

08
1

REAR TOP SHEETING

FOAM BOARD
AP KWAK - VERSION 1.0

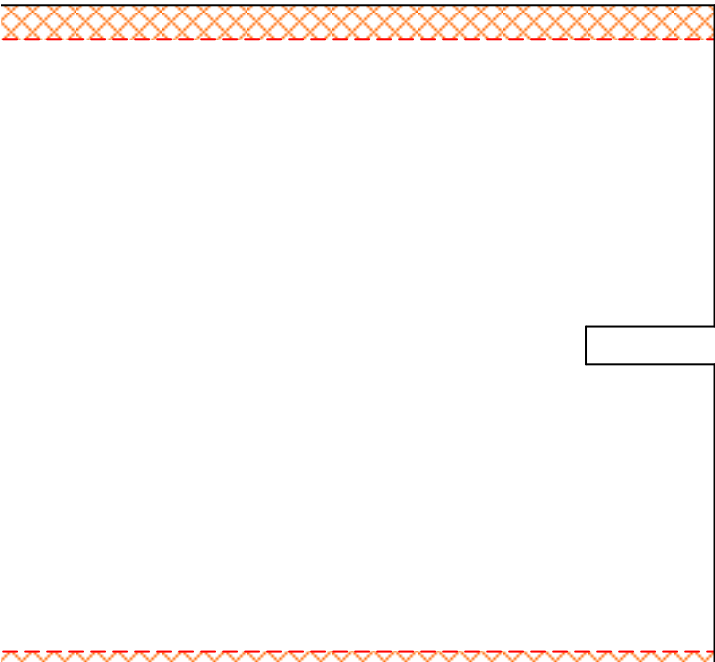
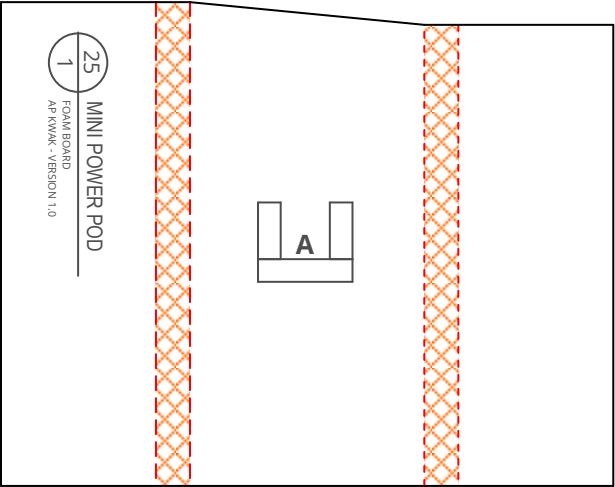
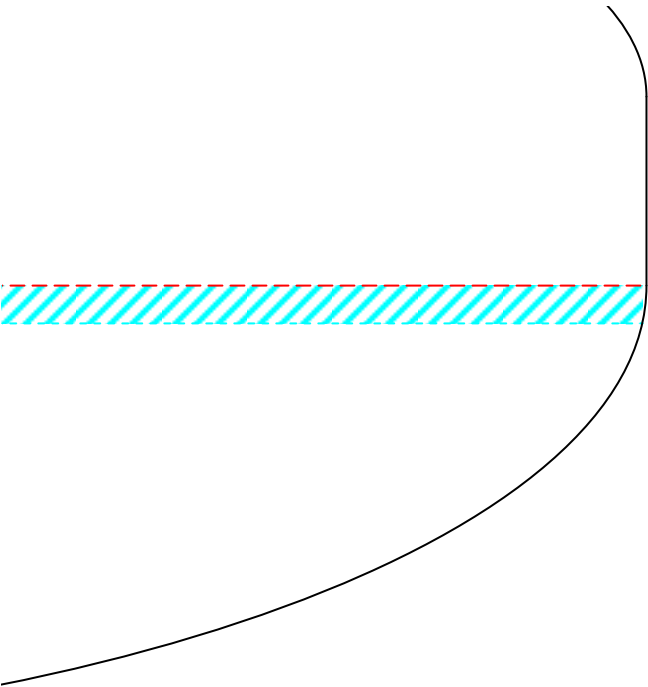

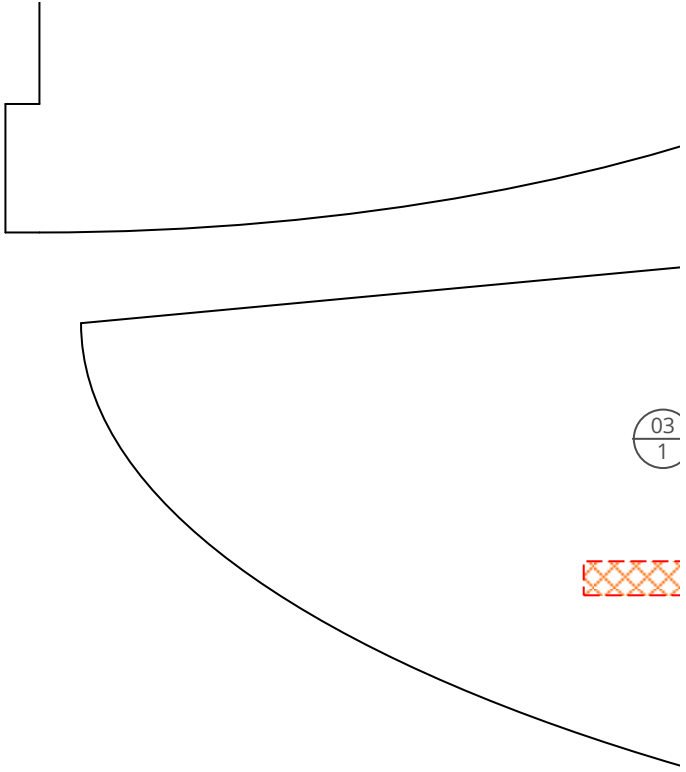

03
1



11 HORIZONTAL STABILIZER SUPPORT
2 BBQ SKEWER
AP KWAK - VERSION 1.0



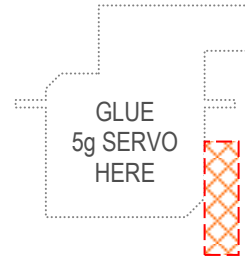
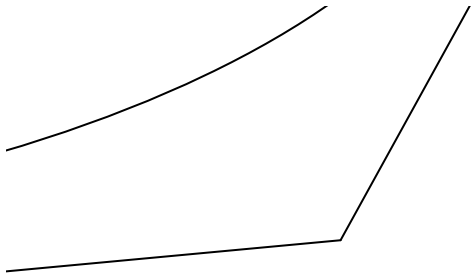

RIGHT SIDE WALL
FOAM BOARD
AP KWAK - VERSION 1.0



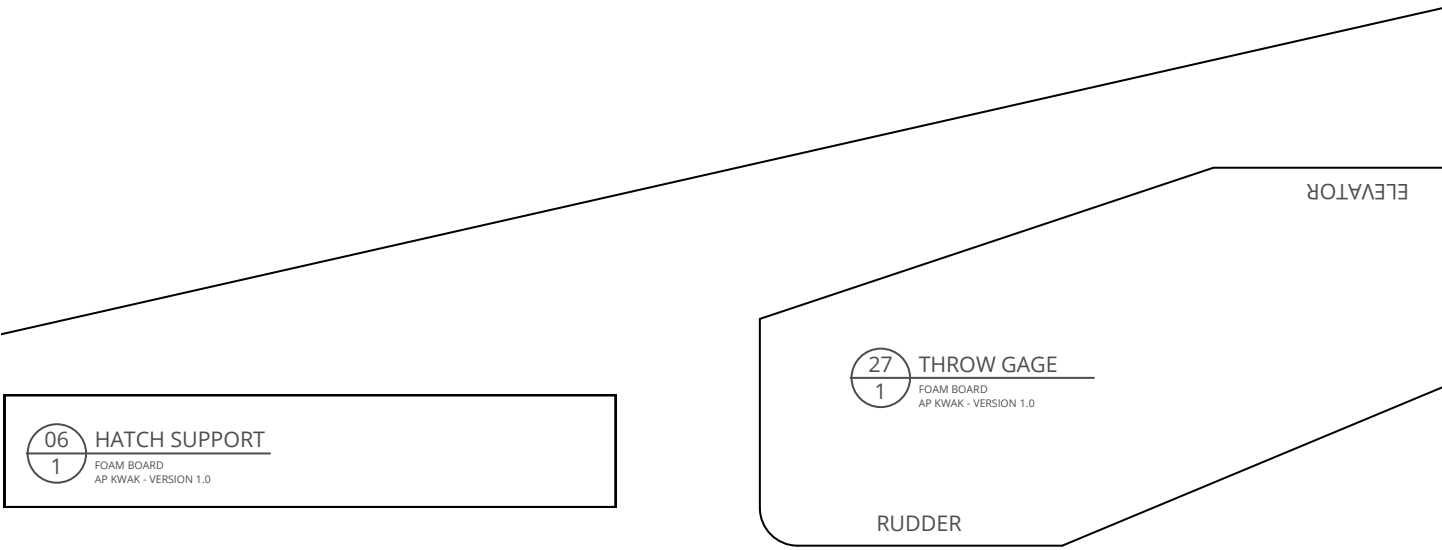
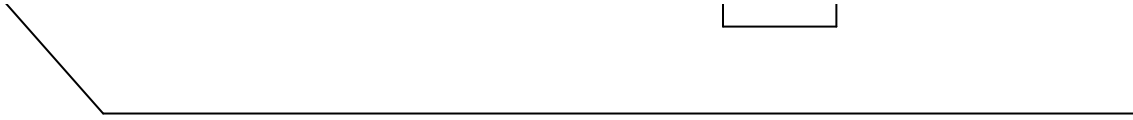

06 HATCH SUPPORT
FOAM BOARD
AP KWAK - VERSION 1.0

27 THROW GAGE
FOAM BOARD
AP KWAK - VERSION 1.0

ELEVATOR

RUDDER



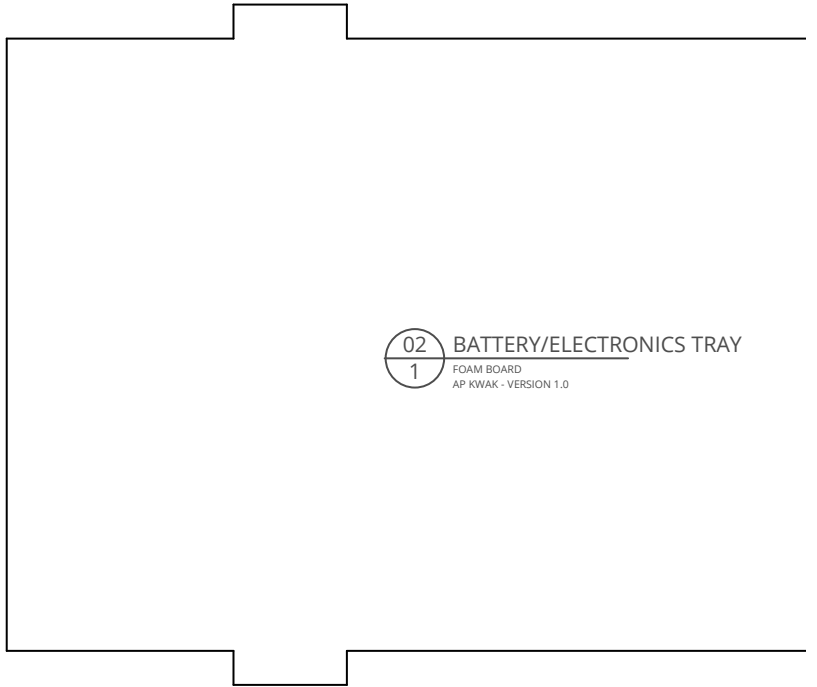
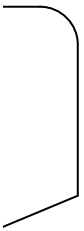
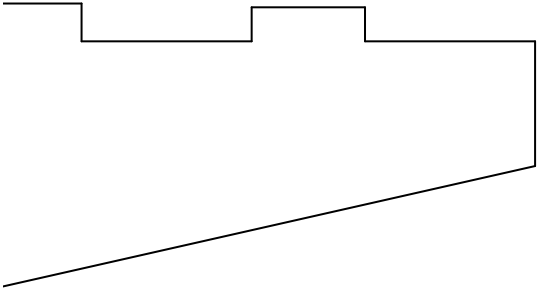

02 BATTERY/ELECTRONICS TRAY
FOAM BOARD
1 AP KWAK - VERSION 1.0

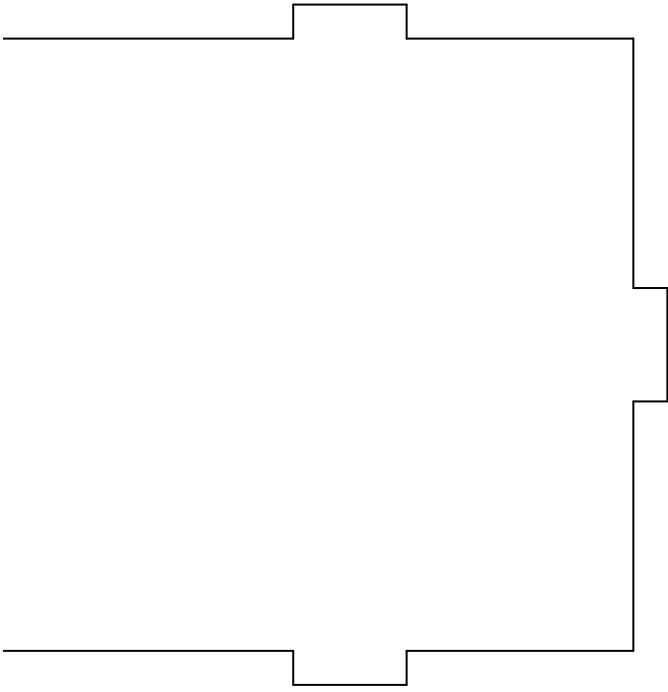

free of charge. Copies allowed for personal use only. Not for commercial use.

AP Kwak

... the Mighty Mini Foam Board Mod of the Jupiter Duck

Drawing by: Tony Roehling

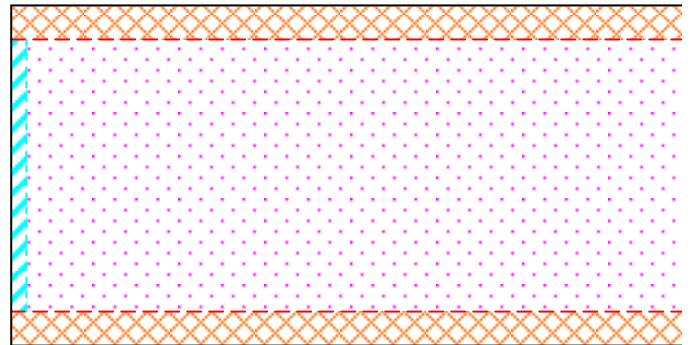

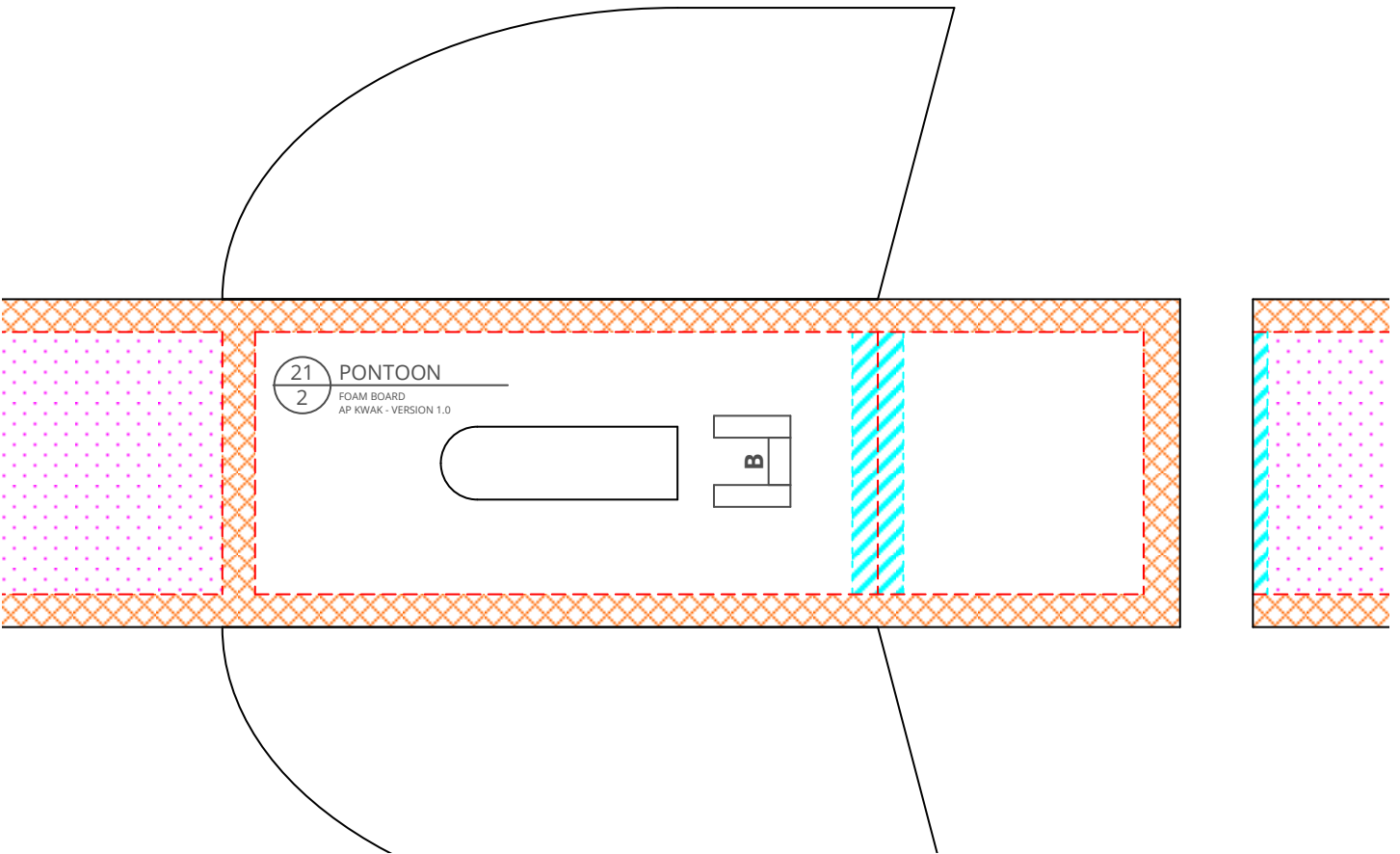

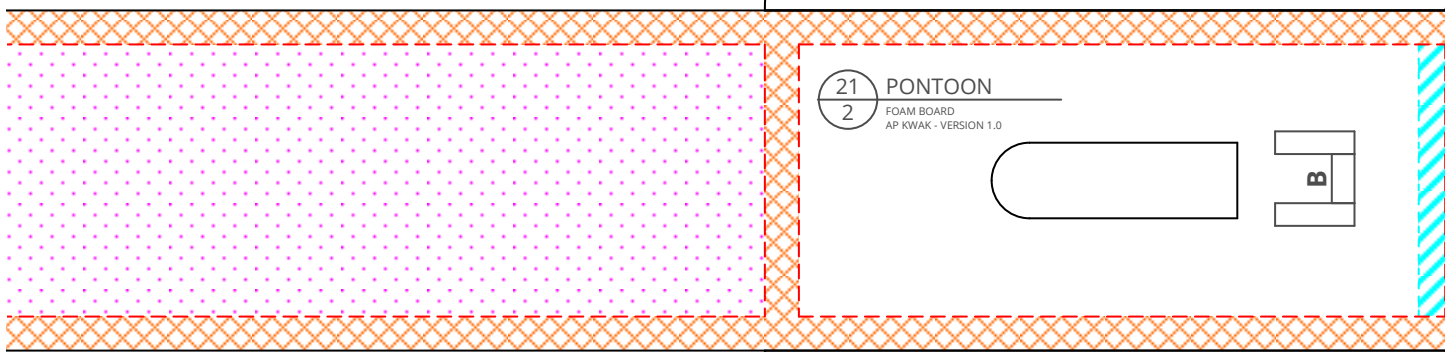

in [redacted]
cm [redacted]

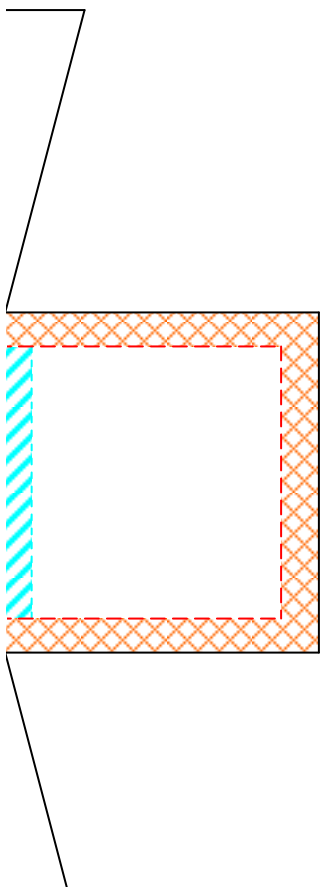

24 PONTOON PYLON SUPPORT
2 FOAM BOARD
AP KWAK - VERSION 1.0



20 POWER POD PIN
2 BBQ SKEWER
AP KWAK - VERSION 1.0

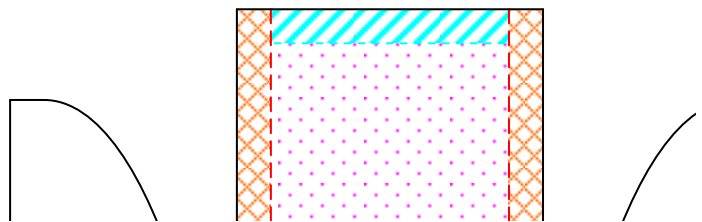

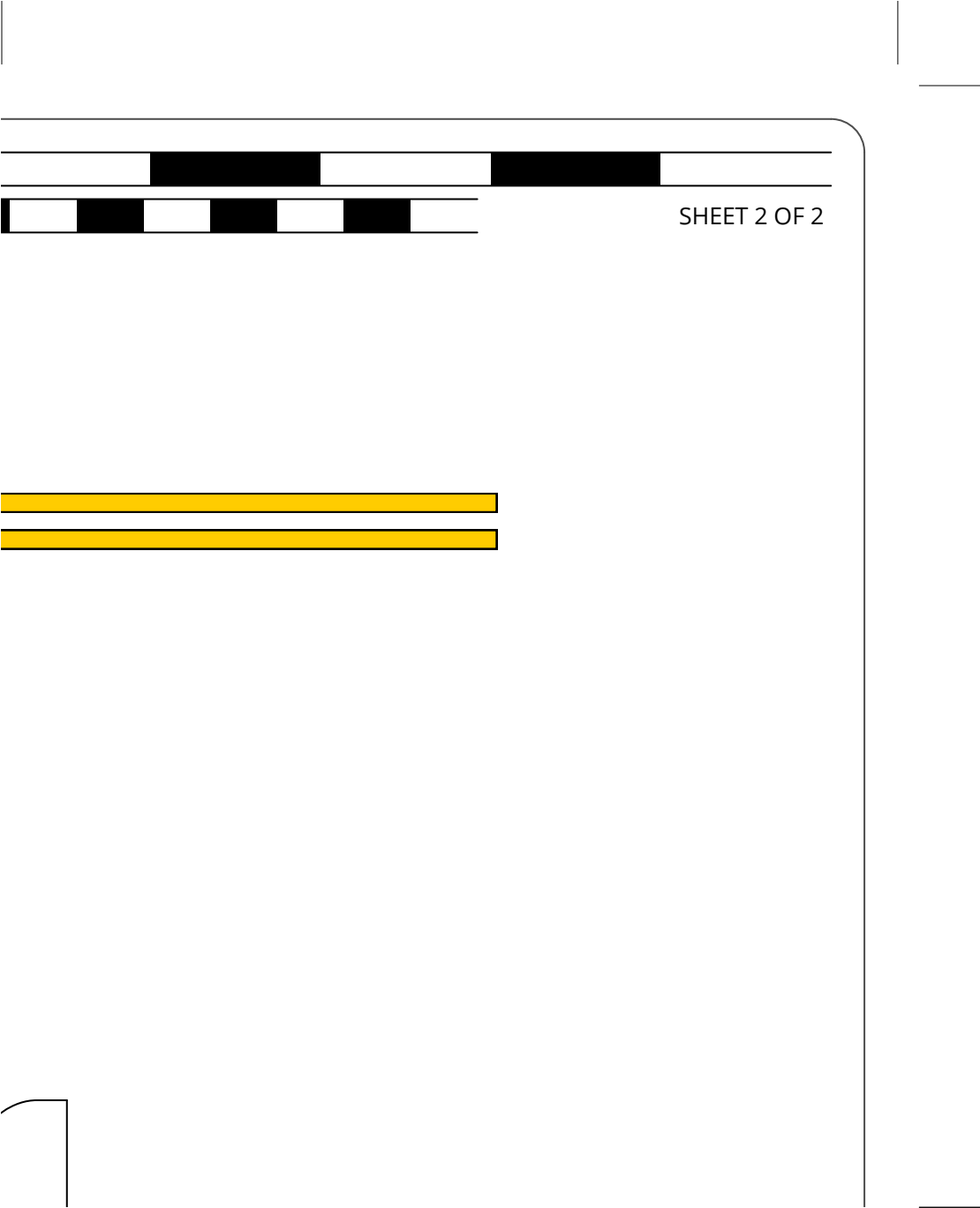

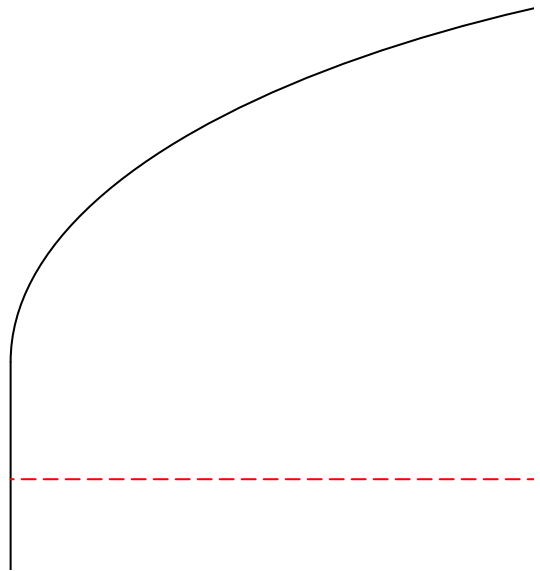
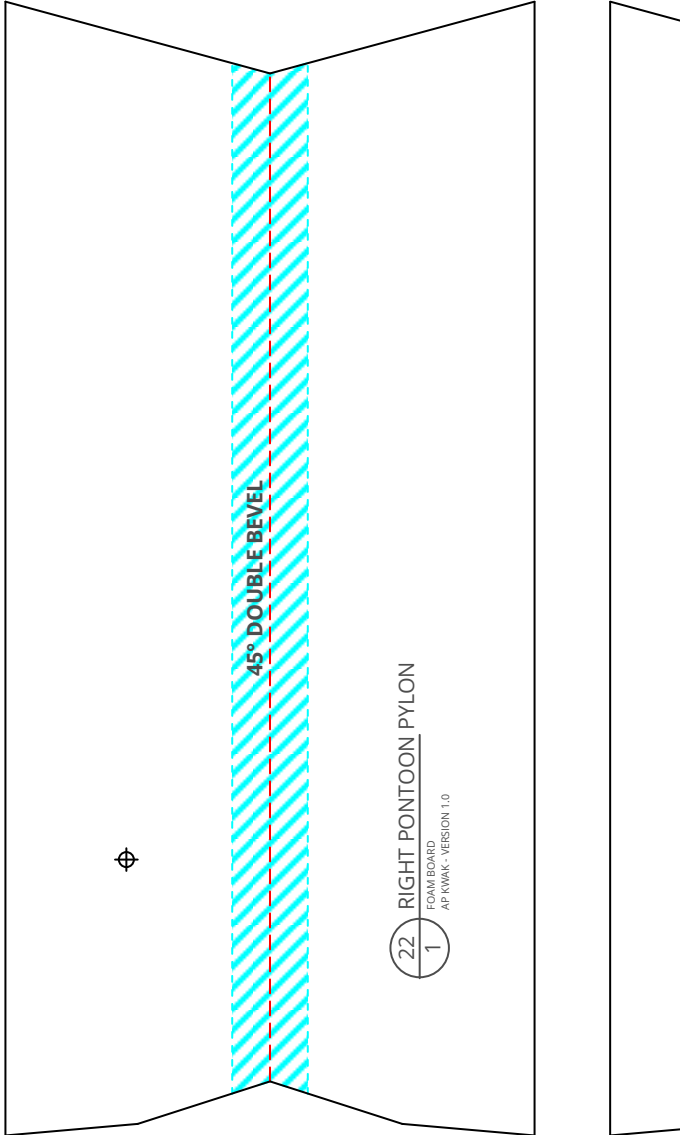

23 LEFT PONTOON PYLON
FOAM BOARD
AP KWAK - VERSION 1.0

45° DOUBLE BEVEL



17 WING
FOAM BOARD
AP KWAK - VERSION 1.0



45° DOUBLE BEVEL

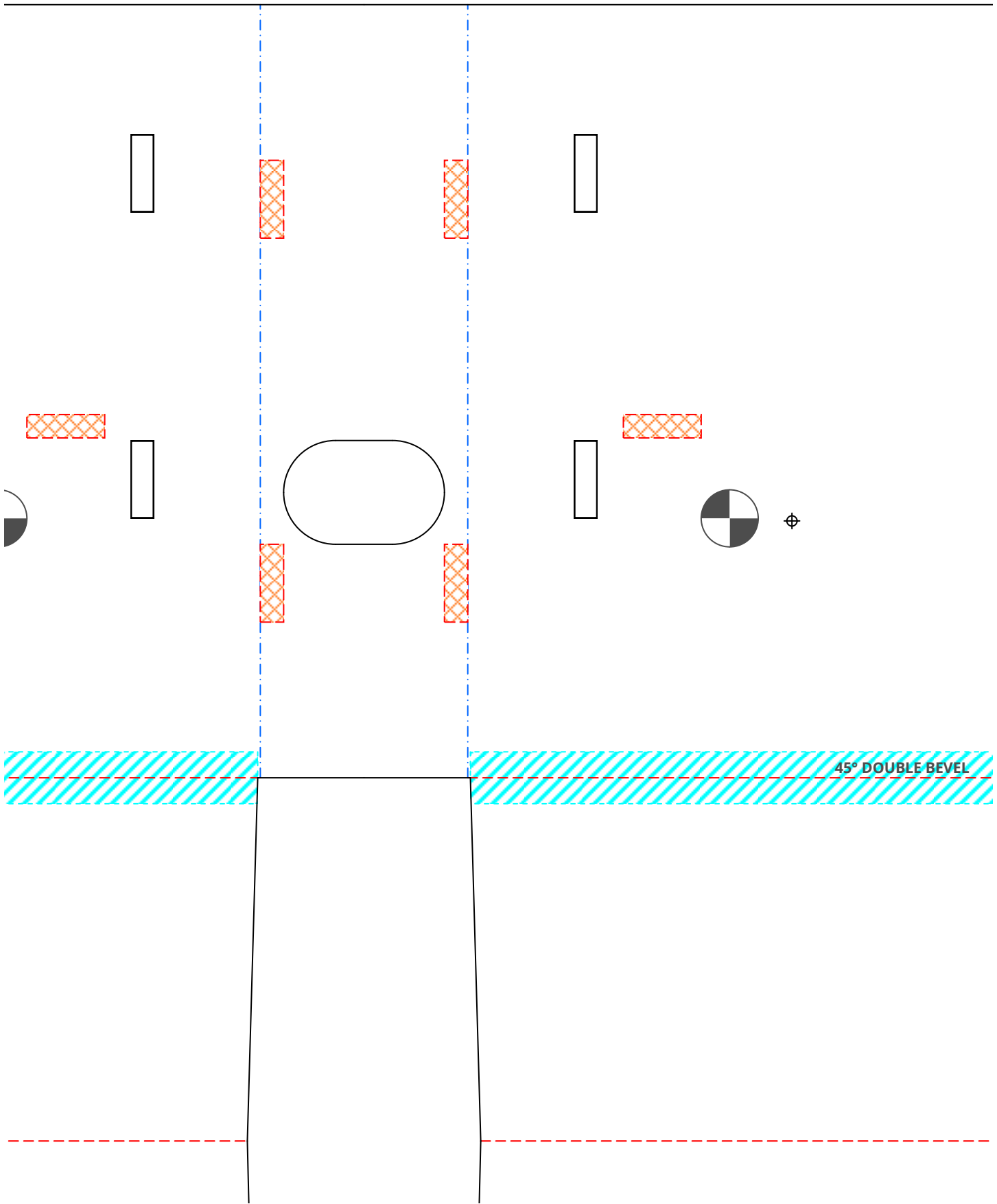

45° DOUBLE BEVEL

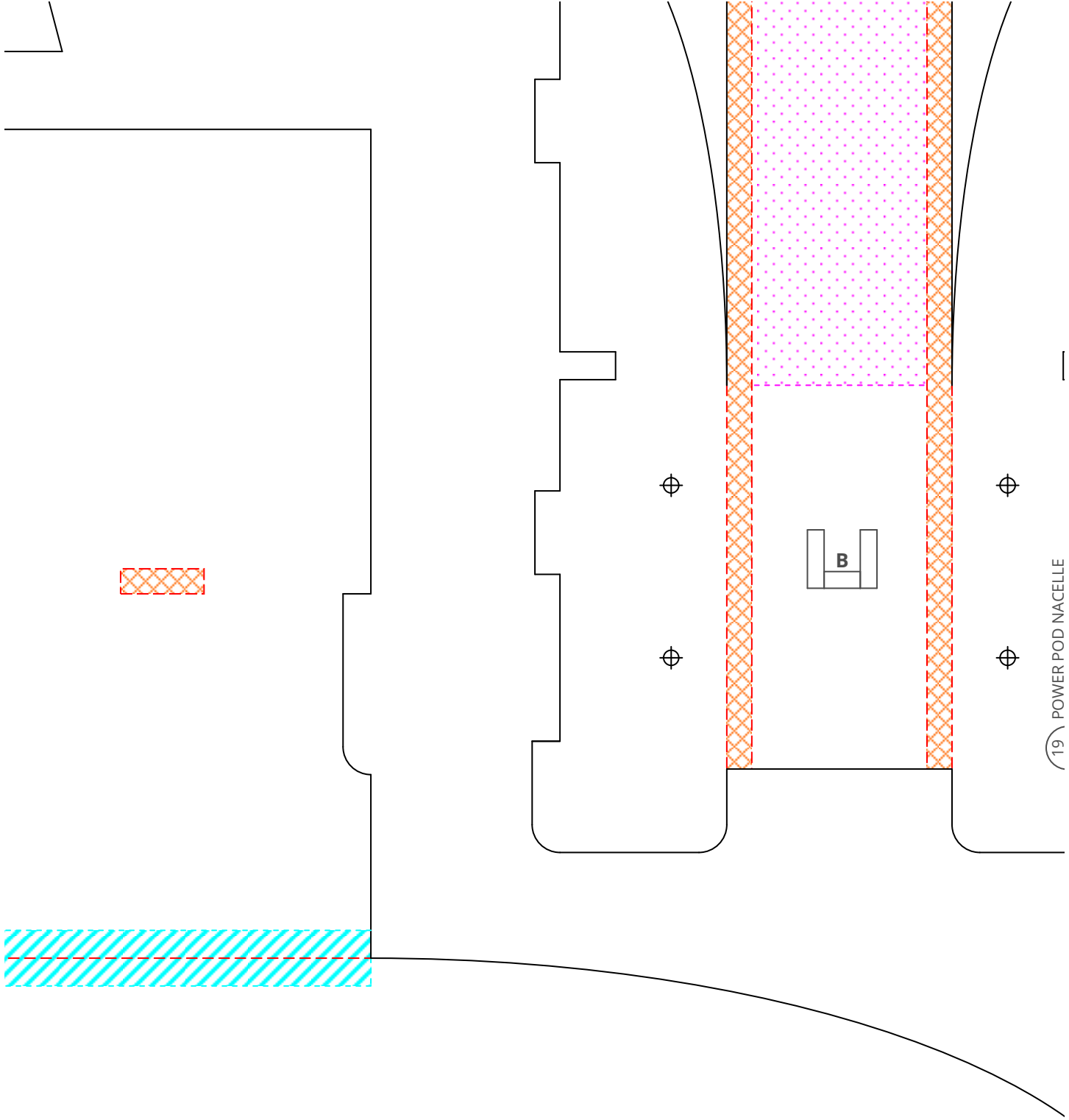

19 POWER POD NACELLE

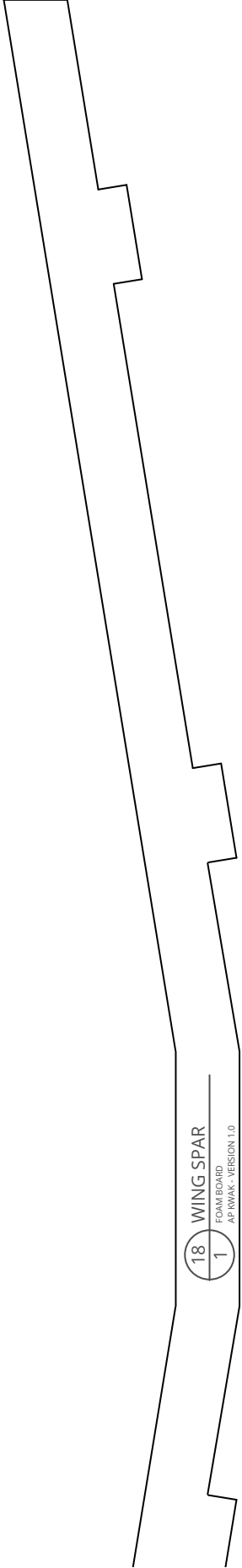
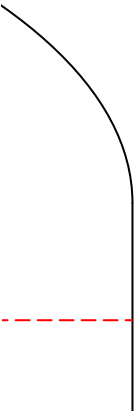
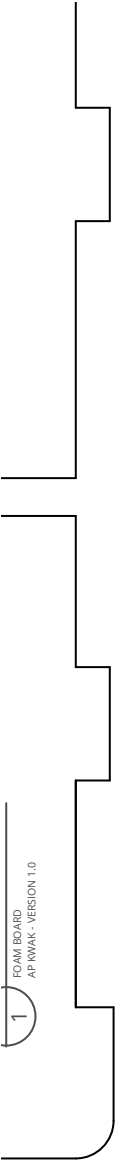



airc-pirates.com

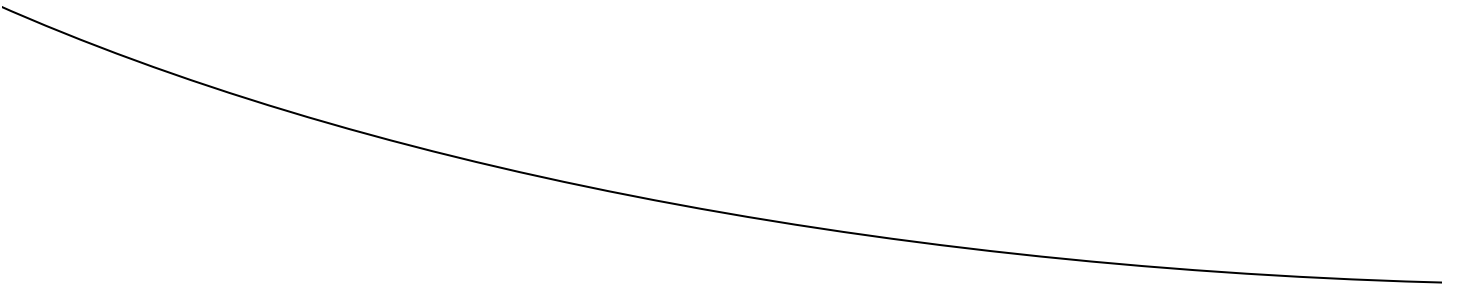

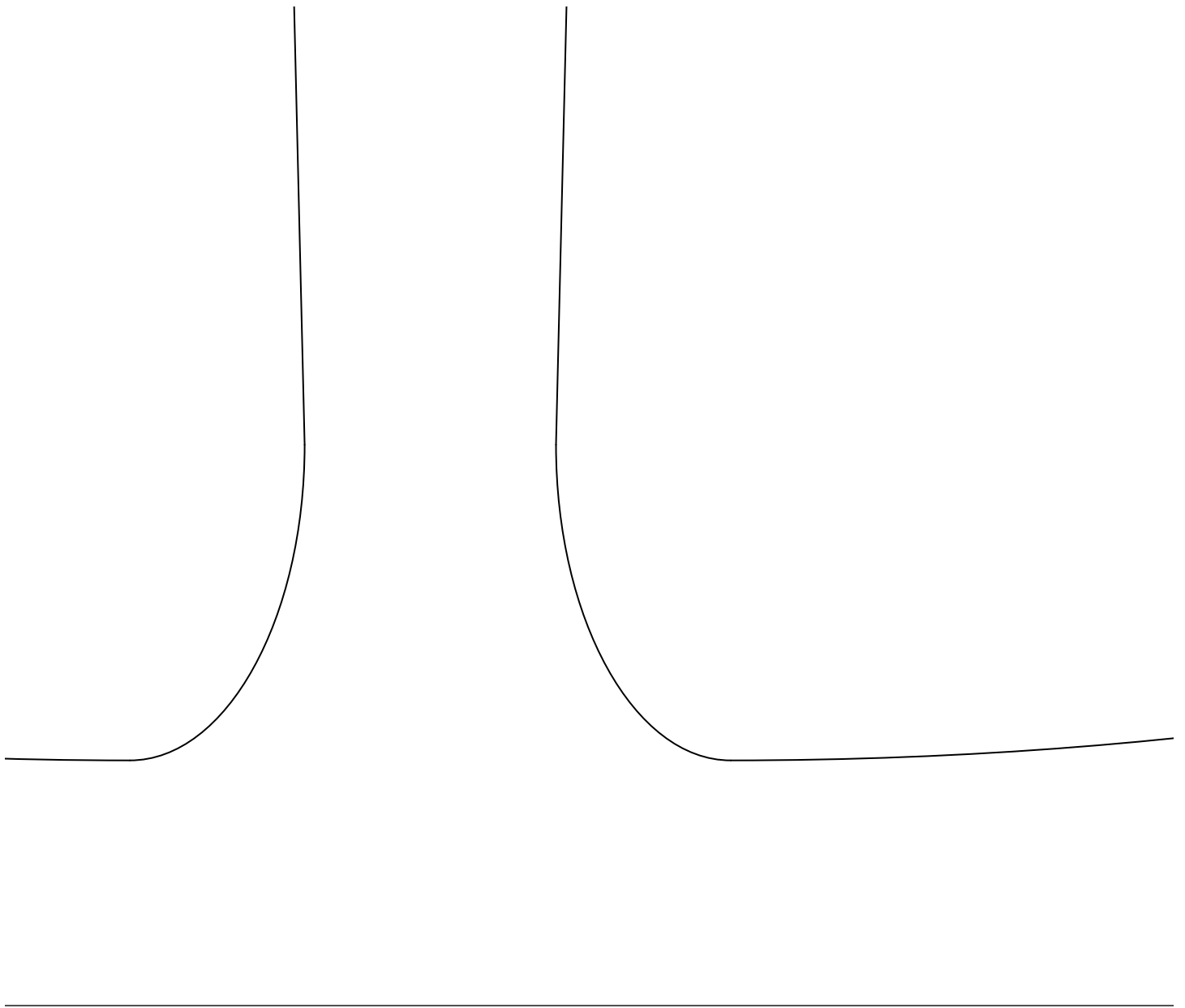

Copyright © 2017 Airc Pirates. Plans provided

free of charge. Copies allowed for personal use only. Not for commercial use.