

Sea

Airc Pirates - the sky is our ocean!

DESIGNED & DRAWING BY: TONY ROEHLING

LINE TYPE / COLOR:

— CUT 

— SCORE CUT 



Duck (Conwing L.

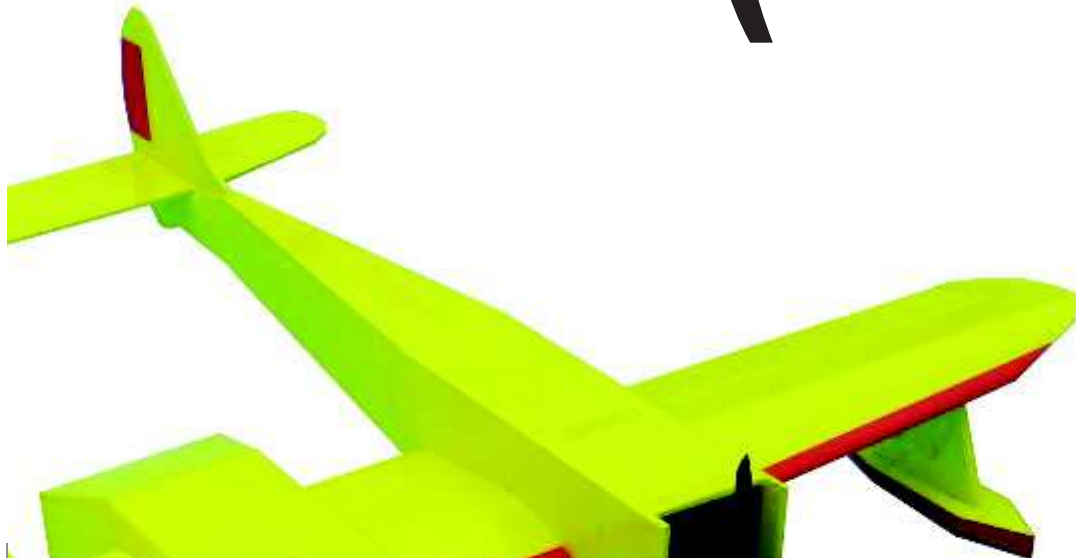

AIRCRAFT SPECIFICATIONS:

LENGTH: 795 mm | 31.30 in

WING SPAN: 900 mm | 35.43 in

CG: 22 mm | 0.87 in

RECOMMENDED EQUIPMENT:

SERVO max. 6: 4.4 g (TGY-1440A)

MOTOR x 2: DYS 1806, 2300 kv

ESC x 2: 12 amp

PROP x 2: 5 X 3 (5030) 1 x CW & 1 x CCW

BATTERY: 4200 mAh 2s (min)

16)

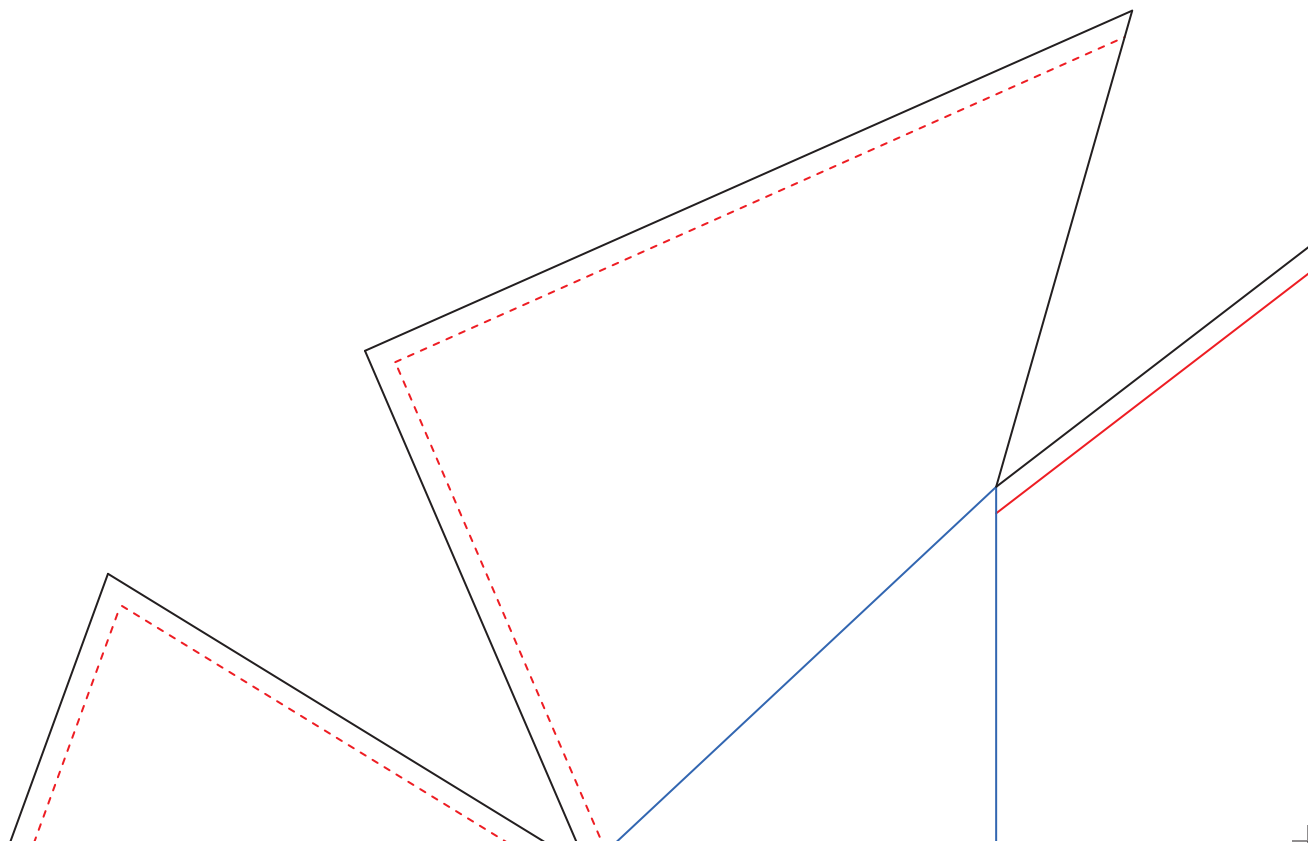



FOAM BOARD SHEET SIZE: 1000 x 700 x 3 mm
SHEET 1 OF 2

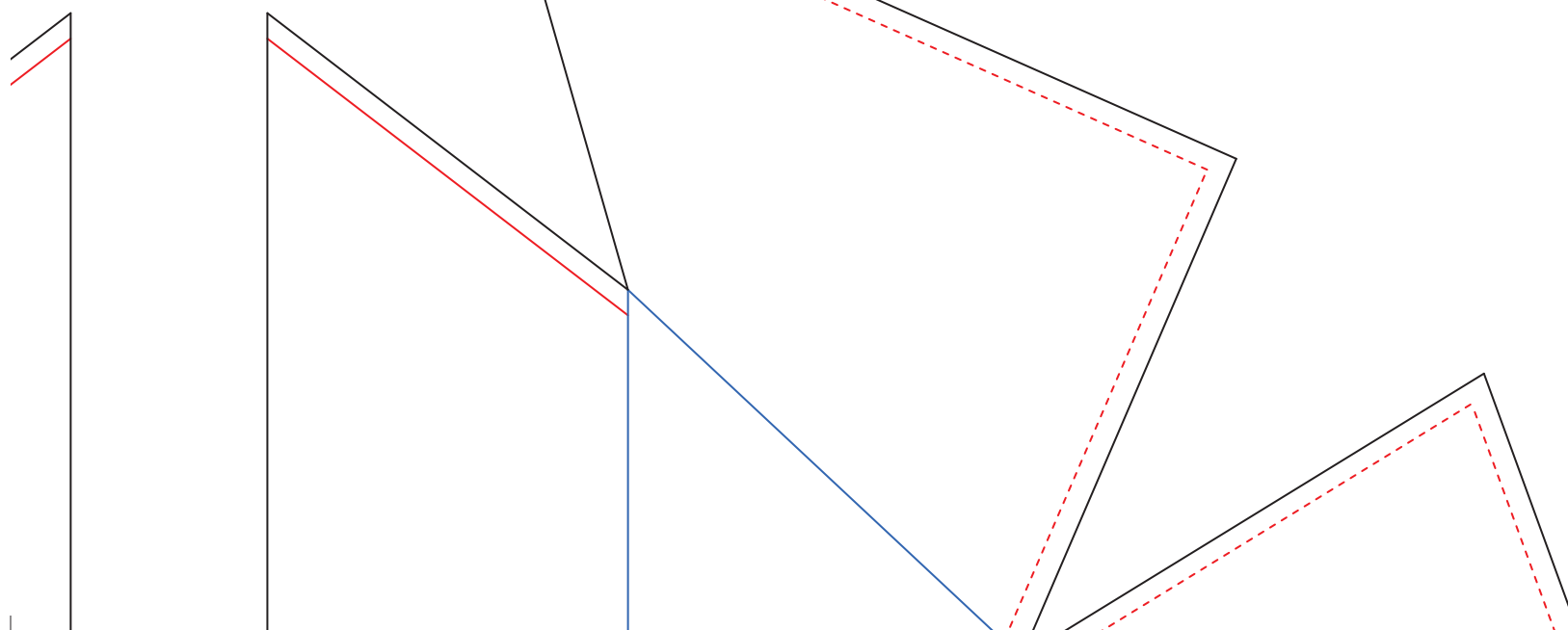

--- BEVEL 45° 

— SCORE CUT & CREASE

PART NUMBER



DESCRIPTION

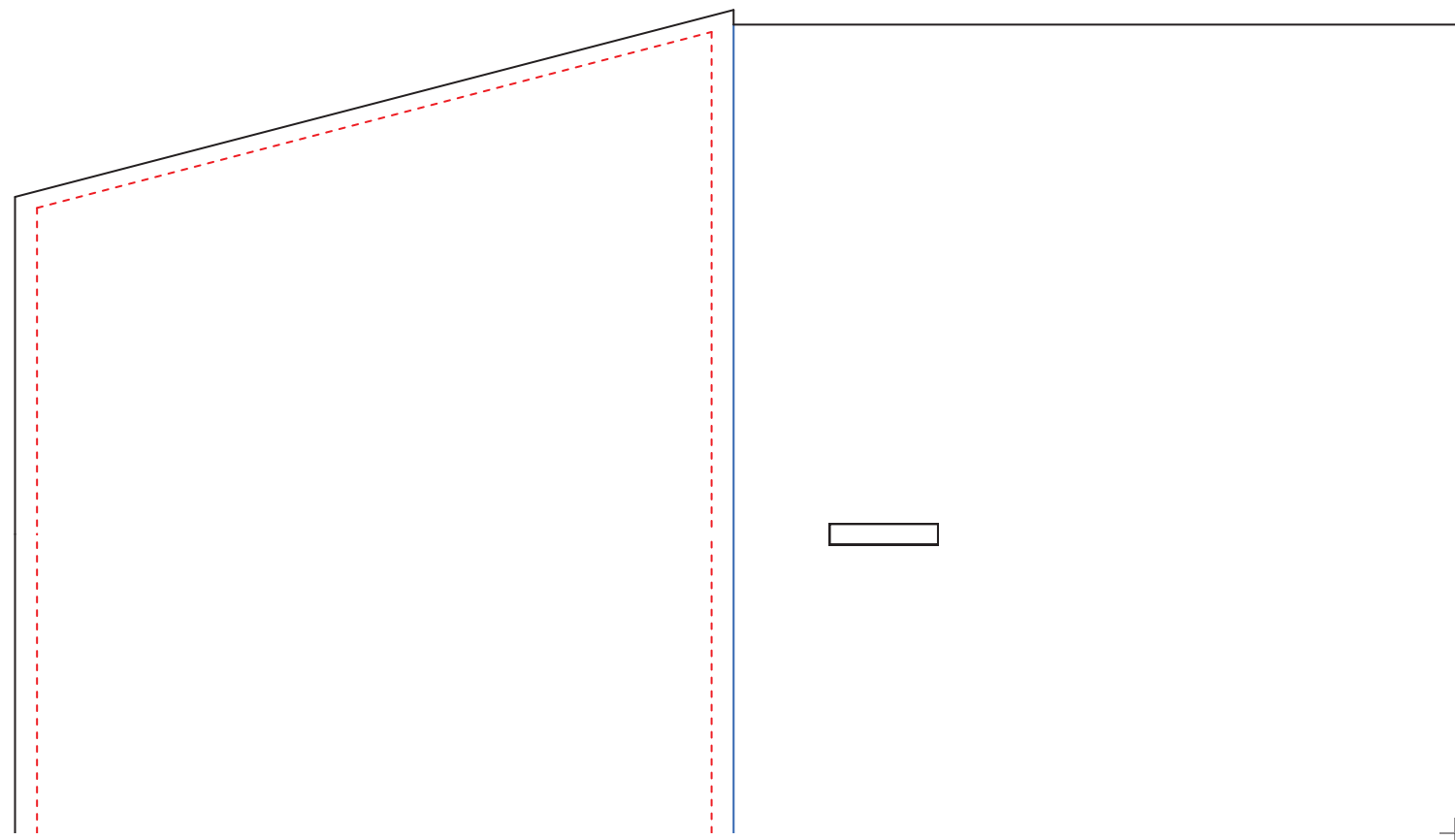
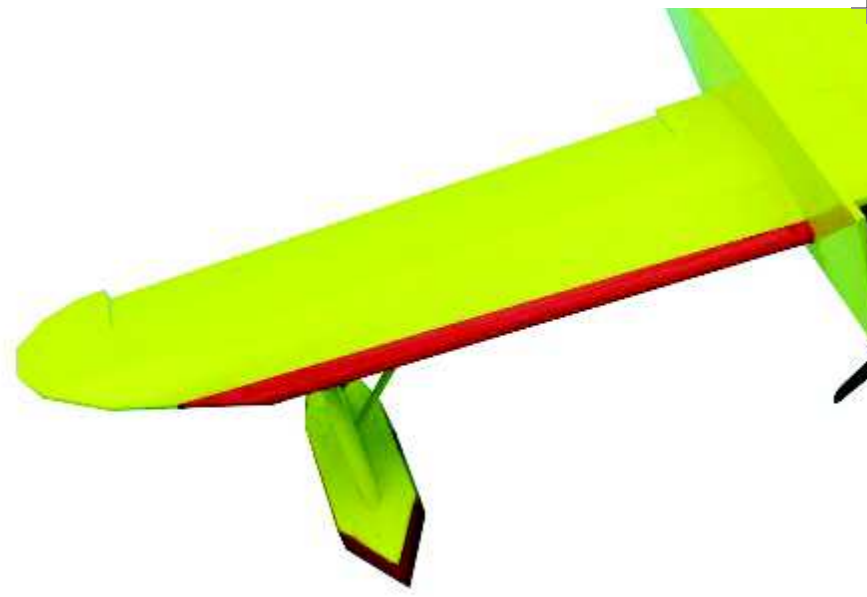

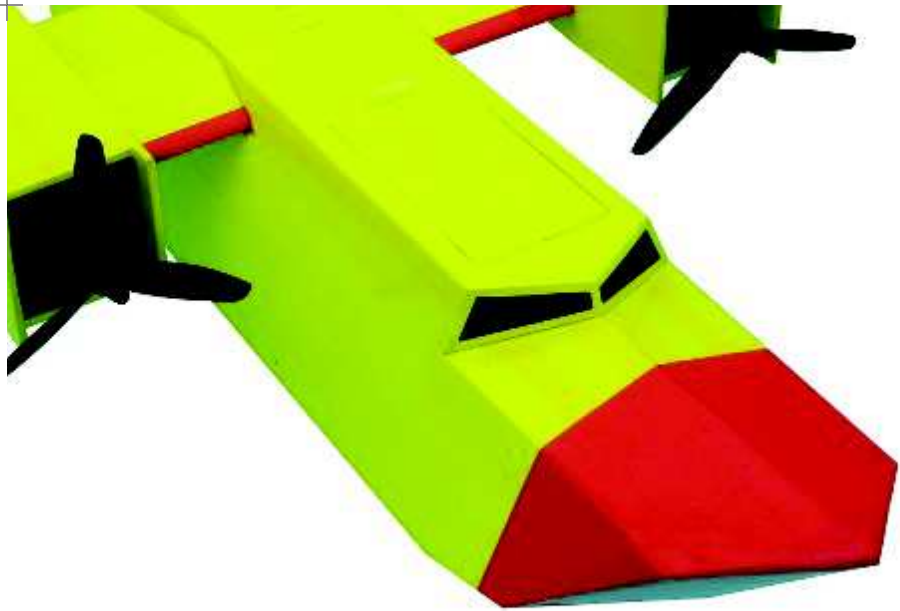

BATTERY: 1500 mAh 3S (min)

WEIGHT W/O BATTERY:

max. 600 g | 21.16 oz

VARIANTS:

- AILERONS | 1 INSIDE ELEVATOR | NO RUDDER (SERVO x 2)
- AILERONS | 2 OUTSIDE ELEVATORS | NO RUDDER (SERVO x 2)
- AILERONS | 1 INSIDE ELEVATOR | 2 RUDDER (SERVO x 4)
- AILERONS | 2 OUTSIDE ELEVATORS | RUDDER (SERVO x 4)



01 FUSELAGE (BATTERY / ELECTRONICS TRAY)

07 FUSELAGE

06 FUSELAGE (WINDOW)

05 FUSELAGE (COVER STOPPER)

3)
0 x 4)
OR 5)
5 OR 6)

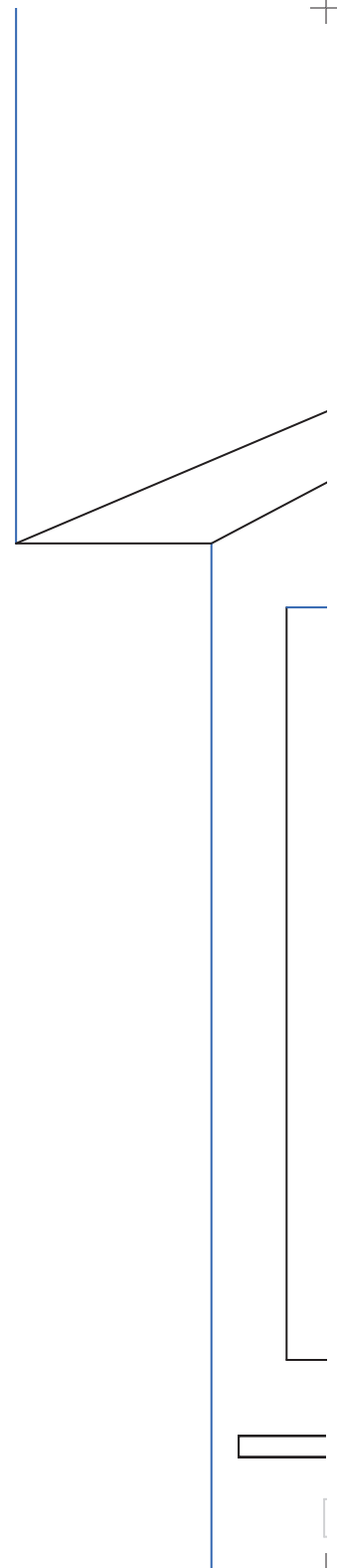
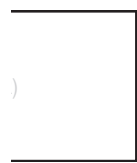
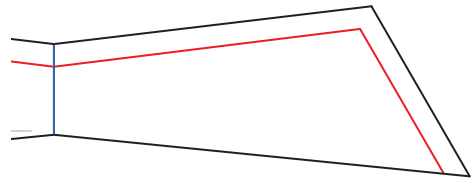
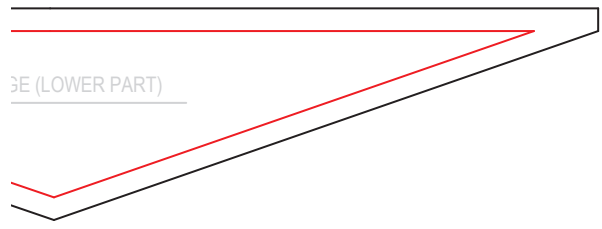

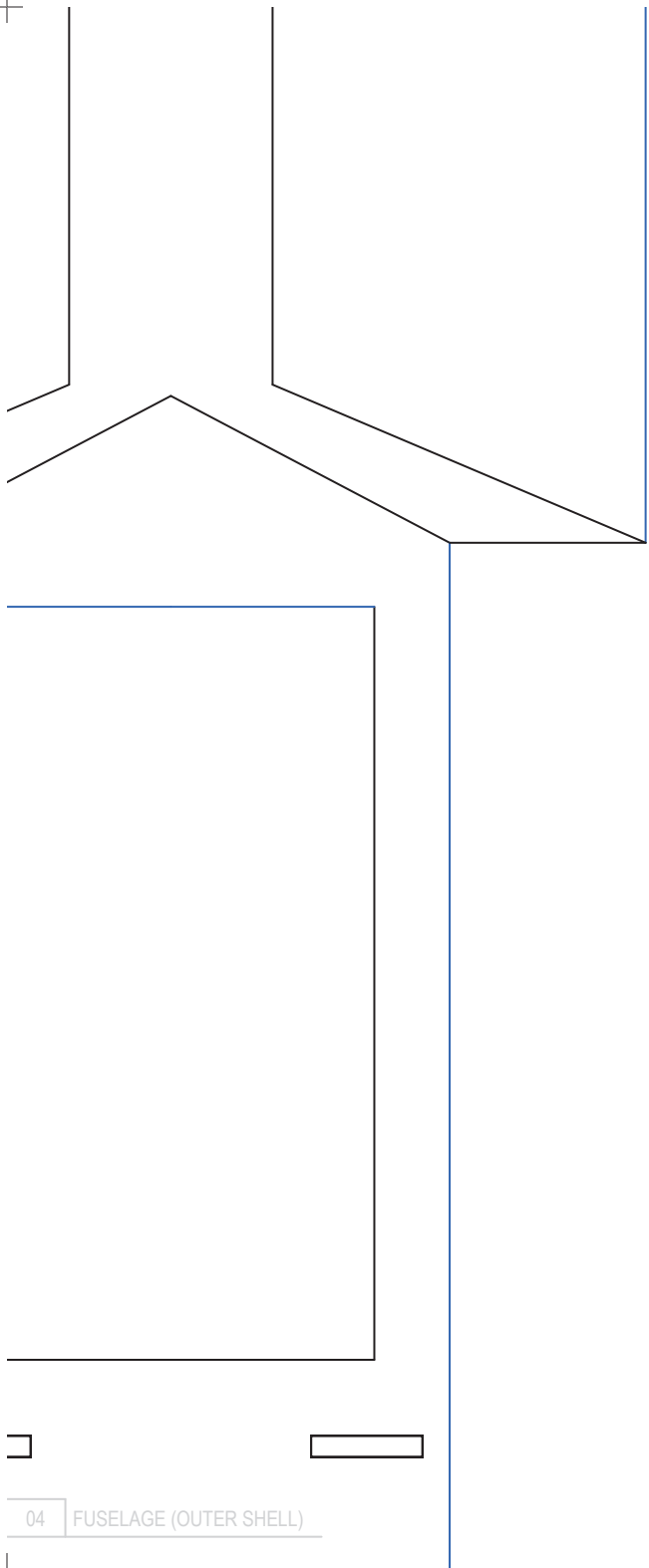

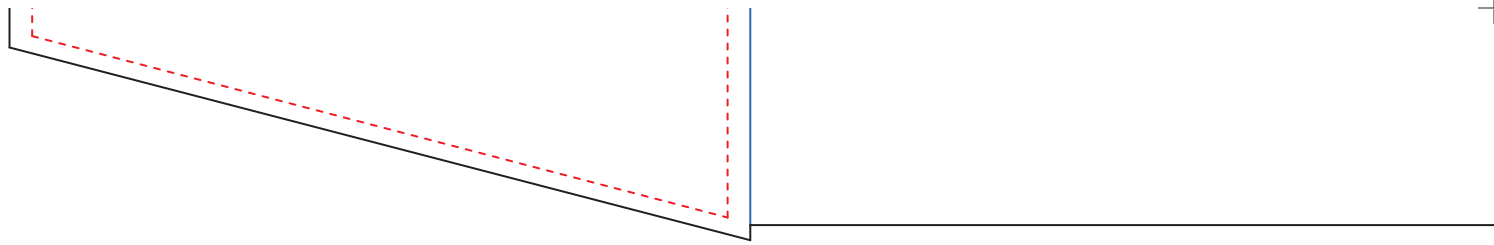

STICKER

AIL-L	AIL-L	AIL-R	AIL-R
ESC-L	ESC-L	ESC-R	ESC-R
ELV-L	ELV-L	ELV-R	ELV-R
RUD-L	RUD-L	RUD-R	RUD-R

35 SERVO EXTENSION LABEL

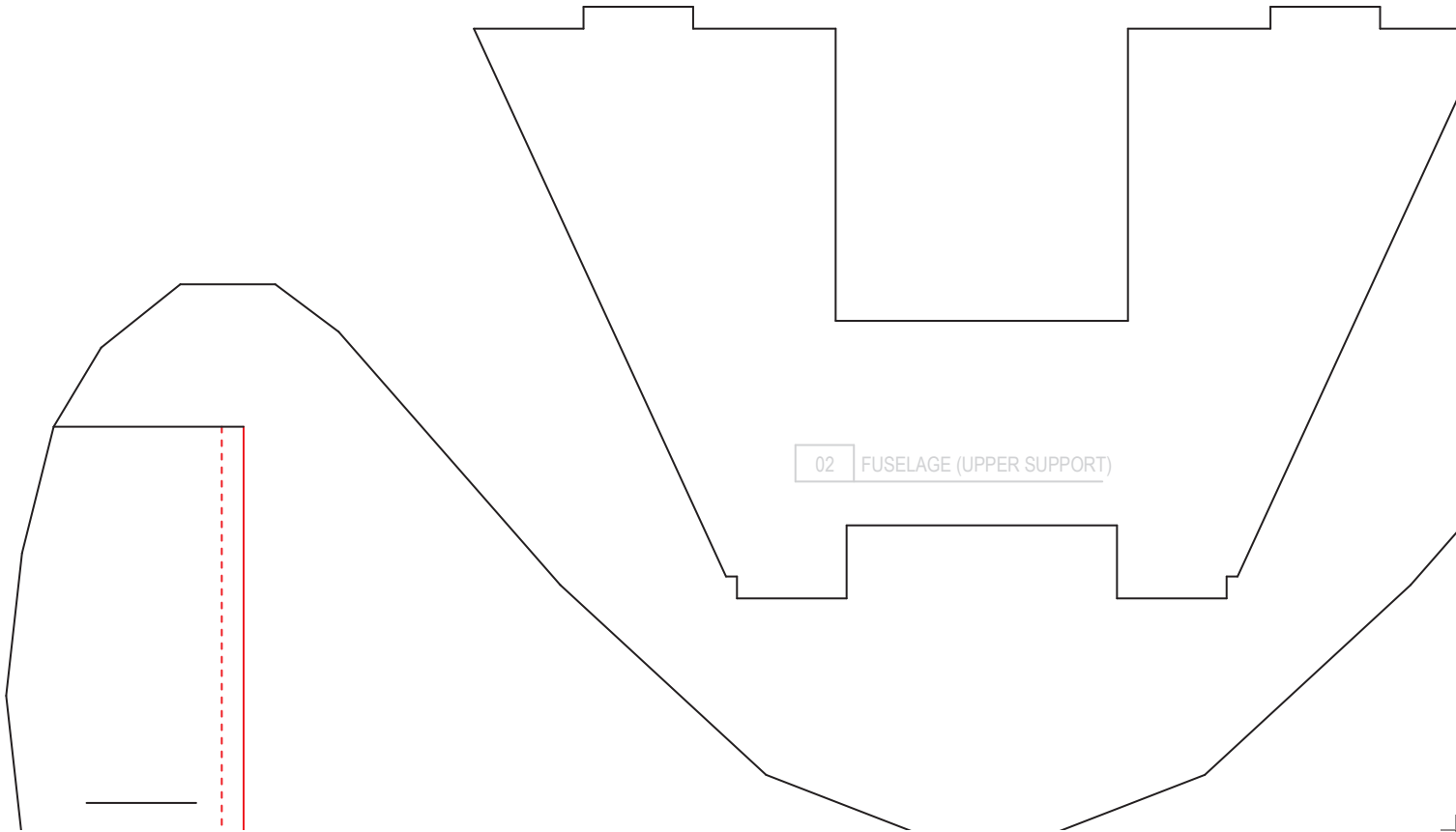
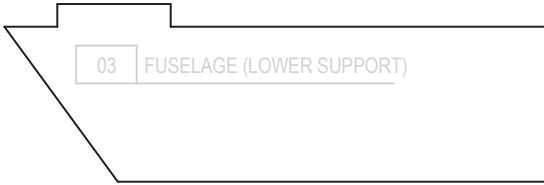

02 FUSELAGE (UPPER SUPPORT)

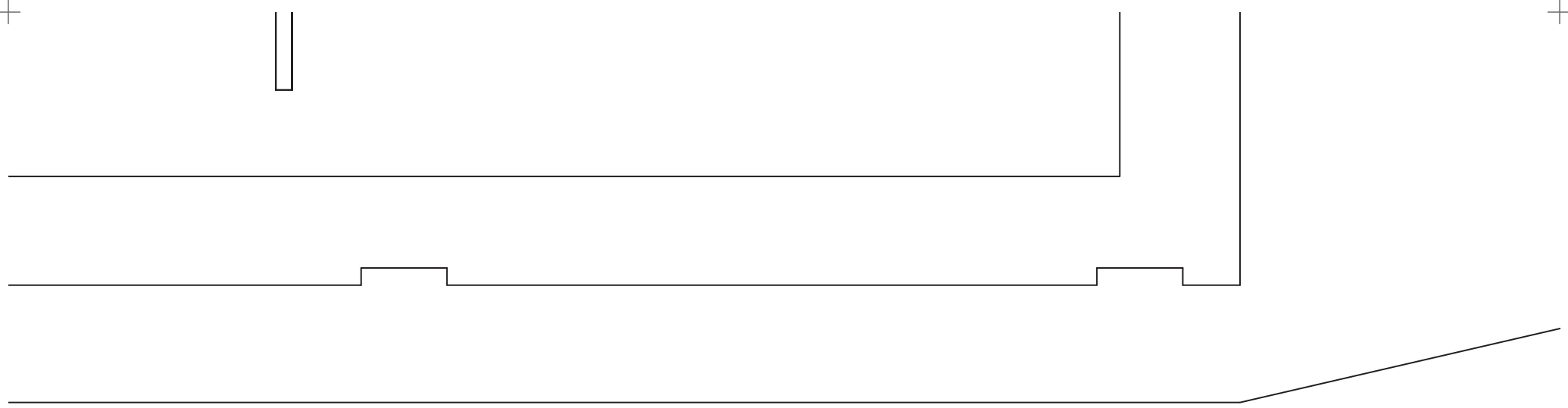

7

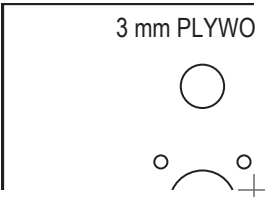
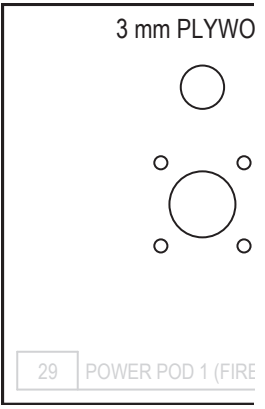
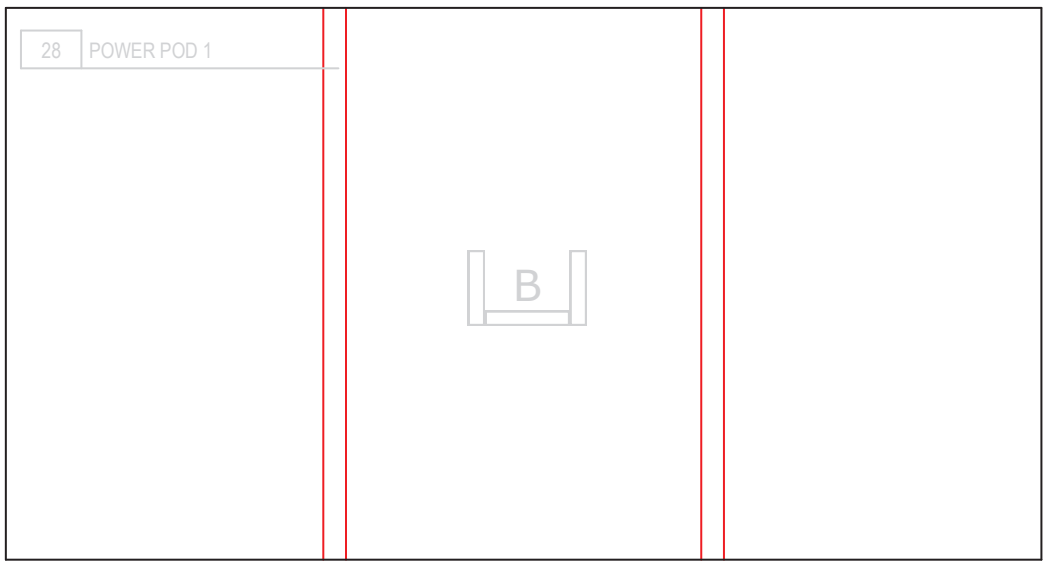
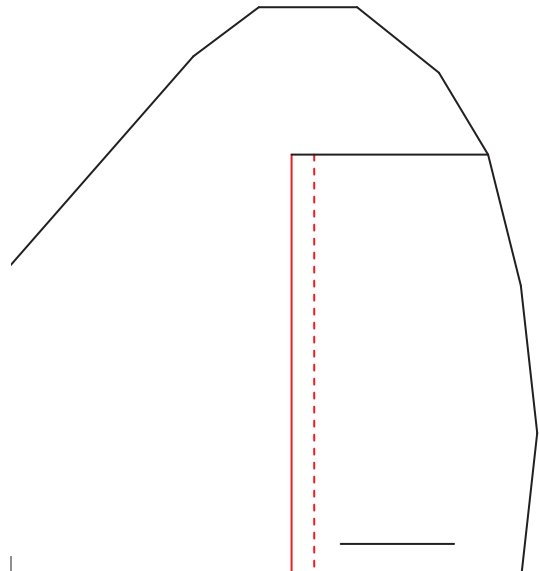

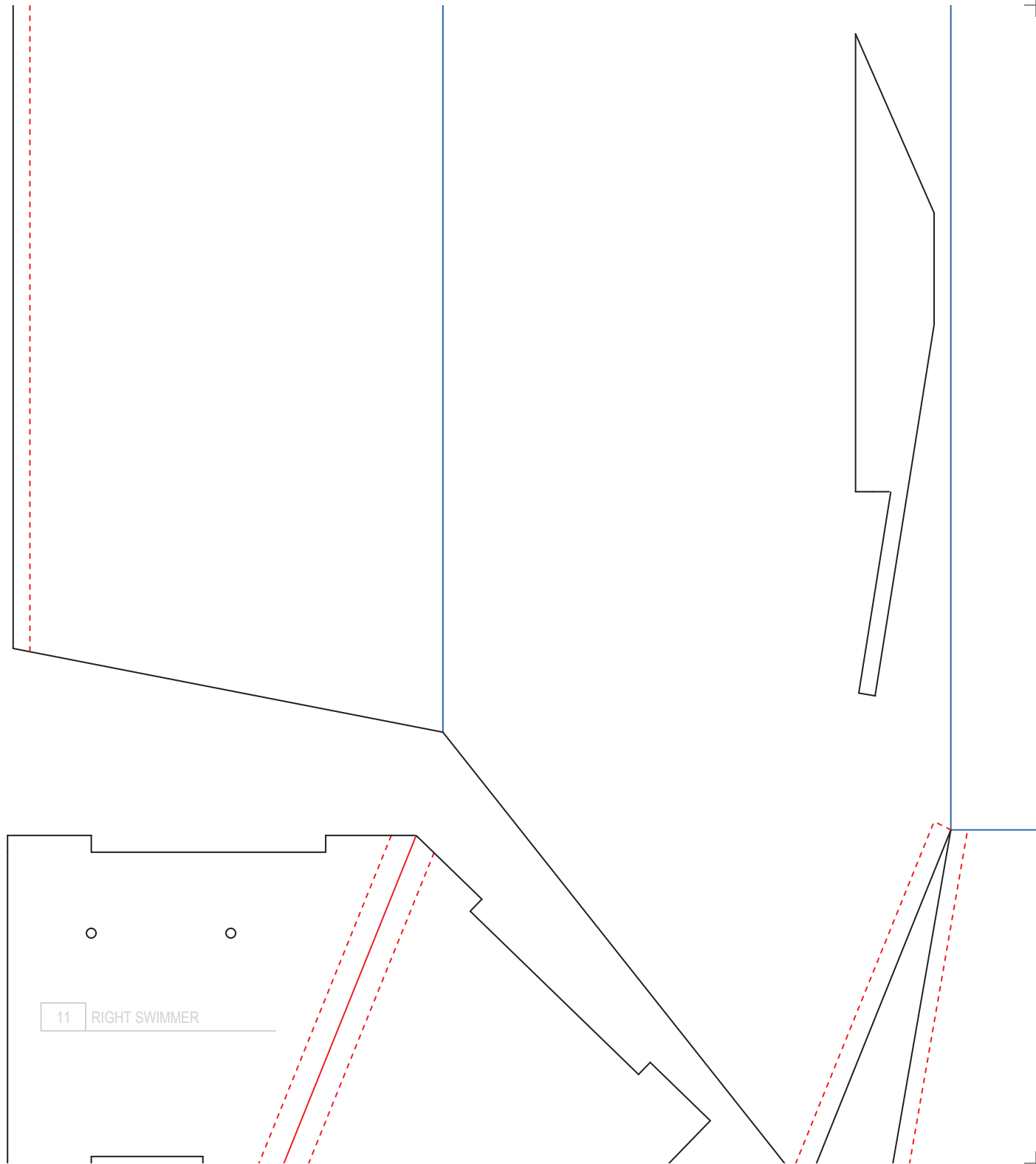
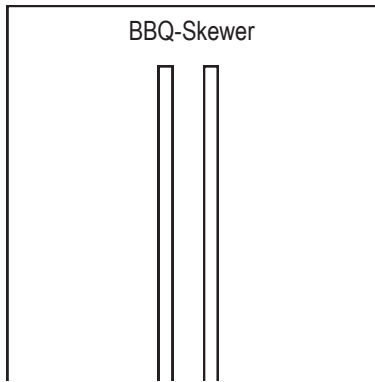
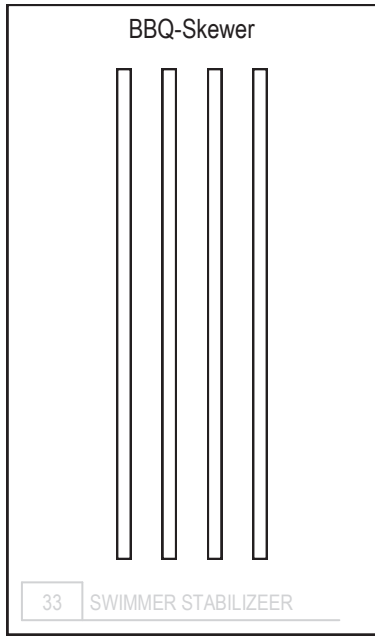
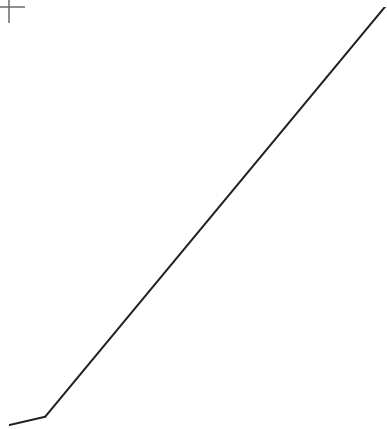

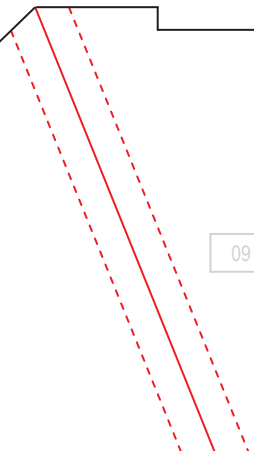
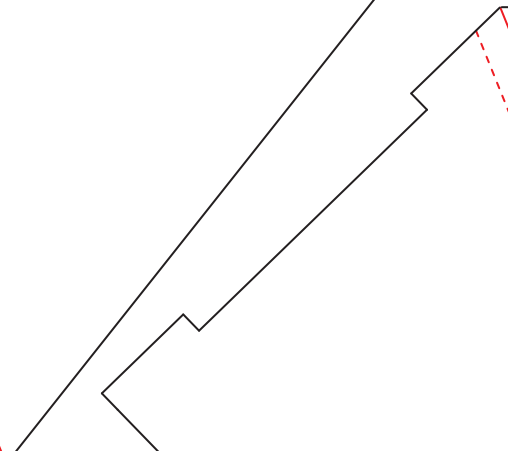
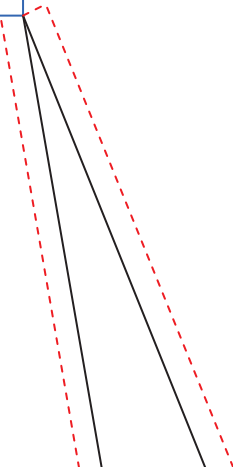
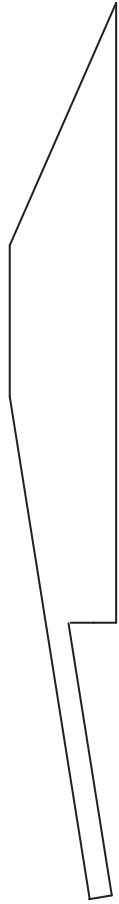

09 LEFT SWIMMER



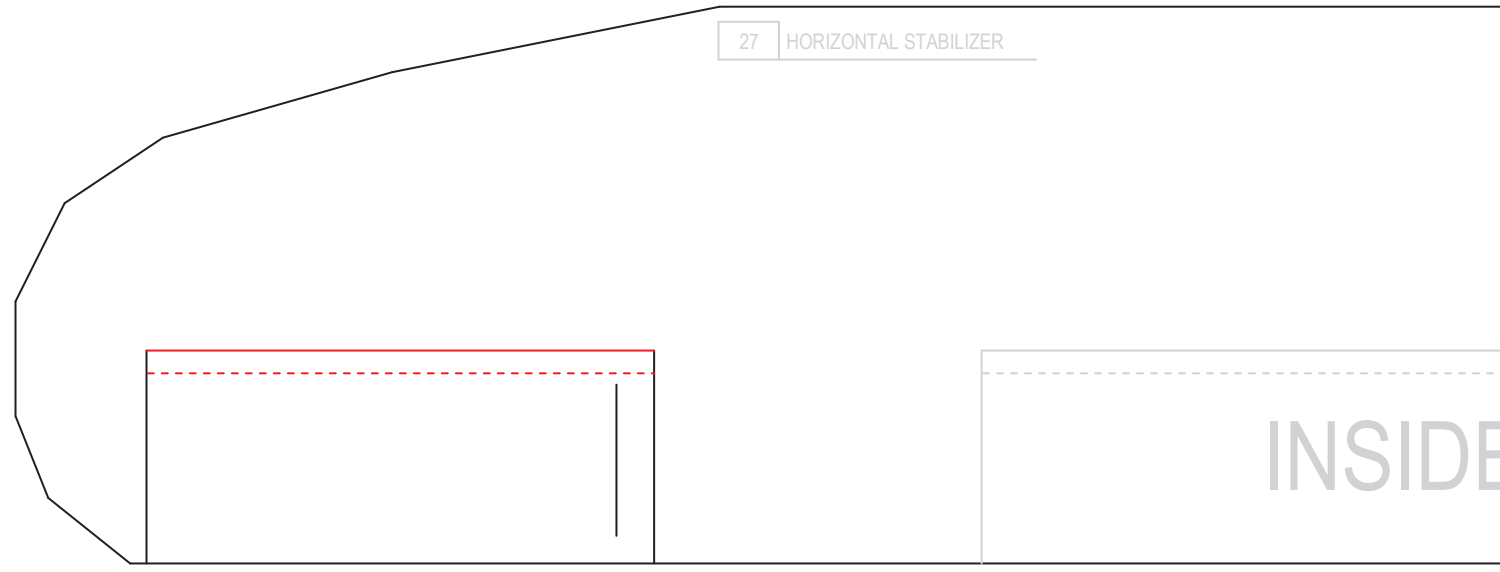
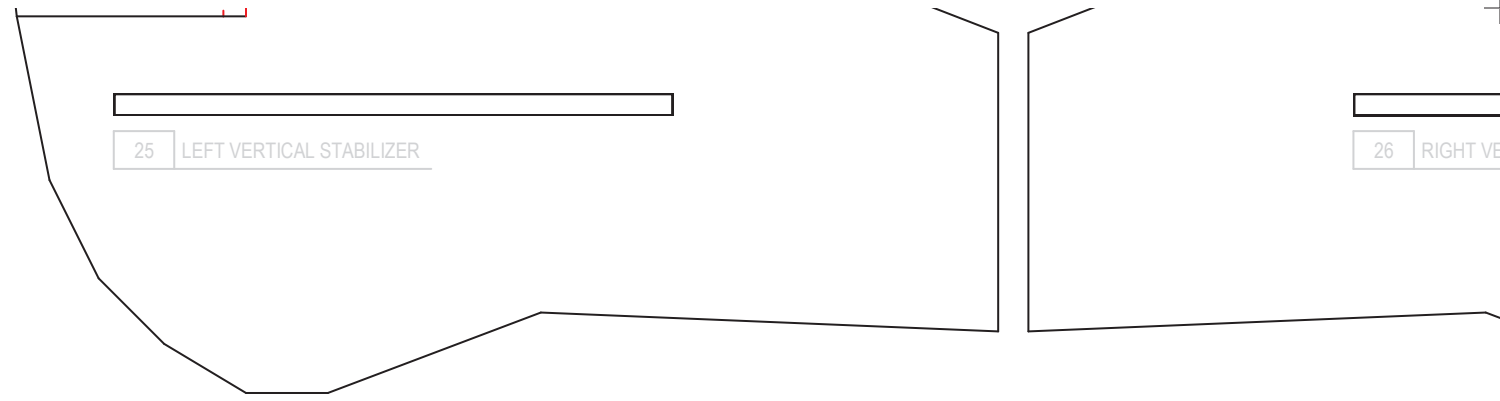

VERTICAL STABILIZER

B

31 POWER POD 2 (FIRE



ELEVATOR (ALTERNATIV)

WALL)

32 POWER POD PINS

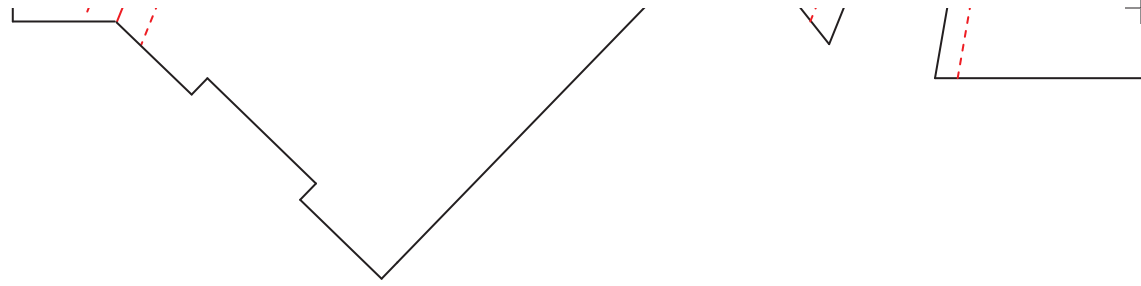

SMALL PLASTIC CARD

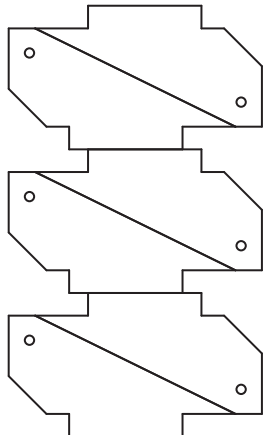

33 CONTROL HORNS

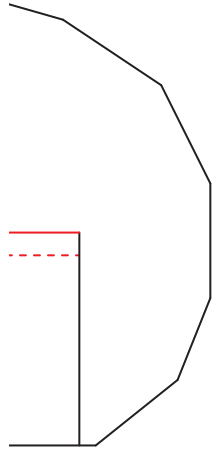

10 RIGHT SWIMMER

B

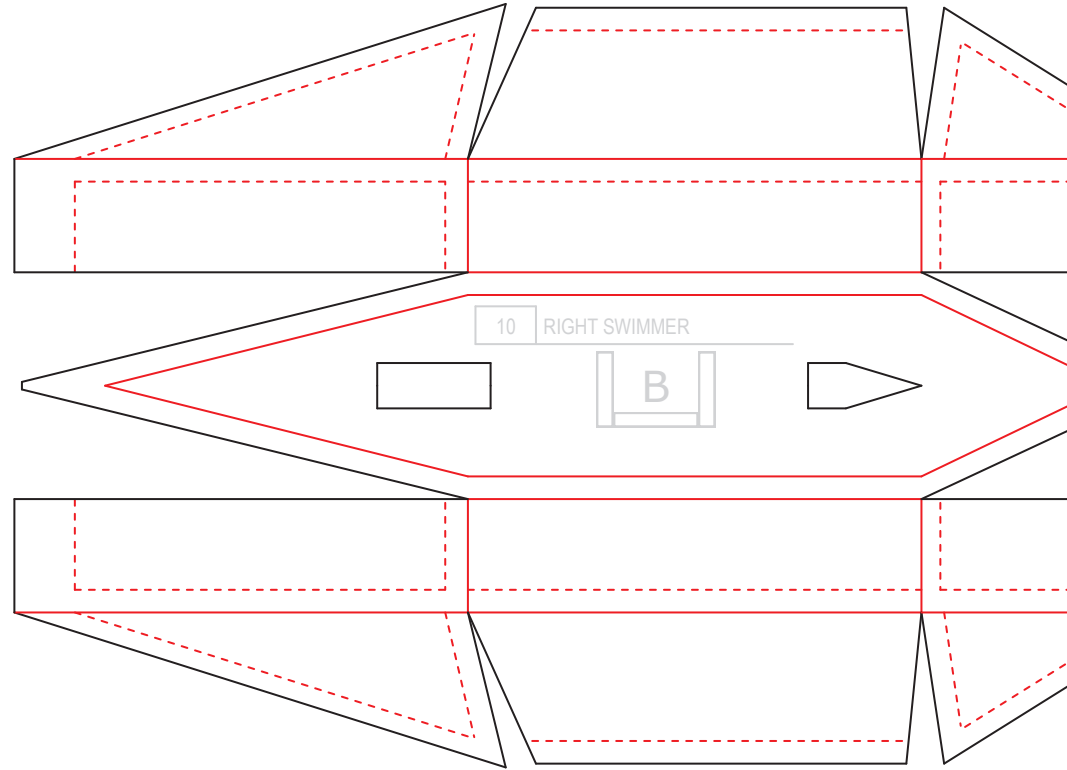

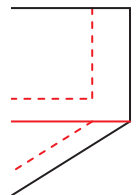
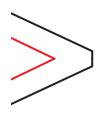
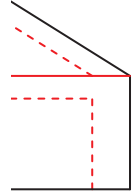
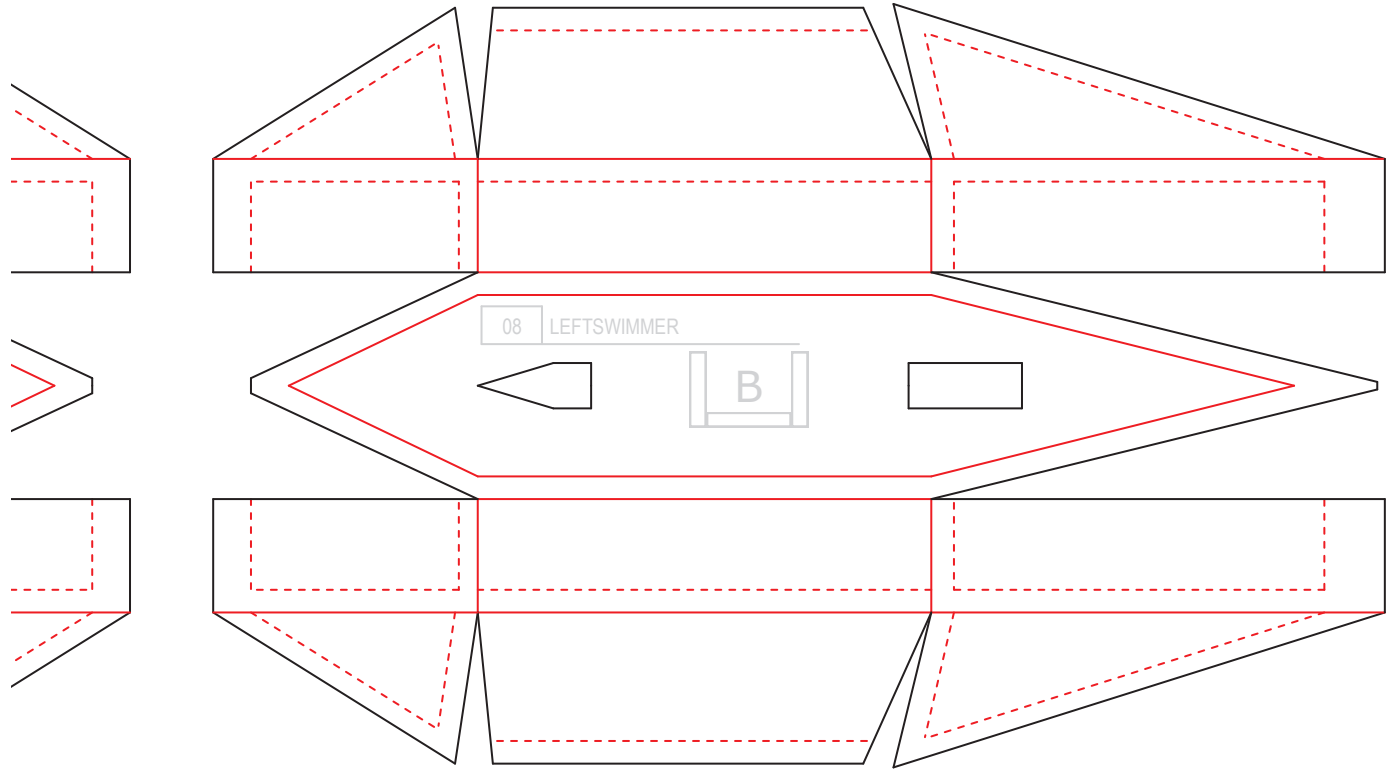
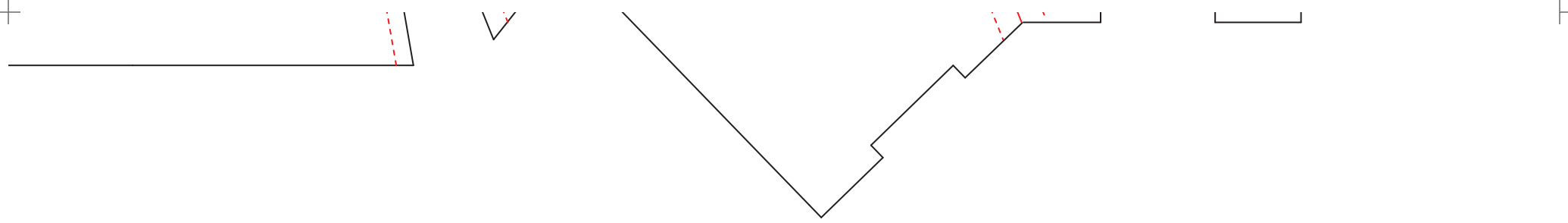



Sea

Airc Pirates - the sky is our ocean!

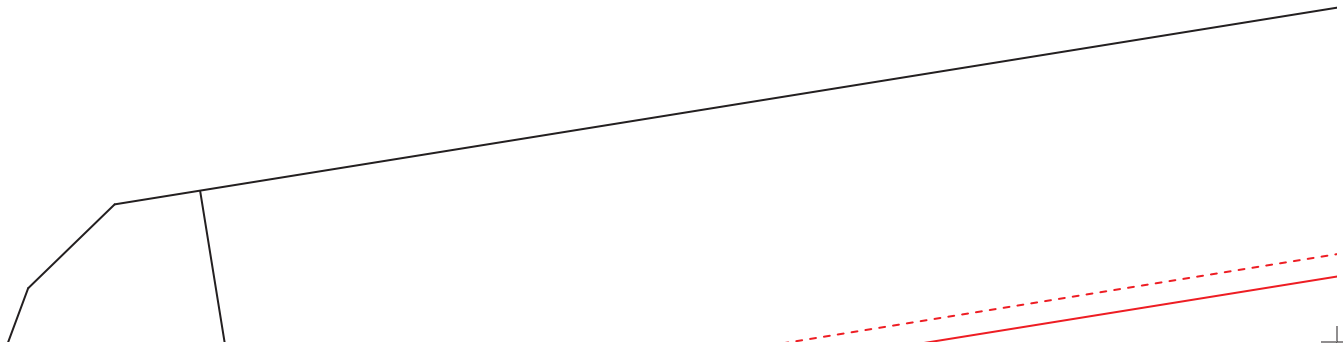

Duck (Conwing L.

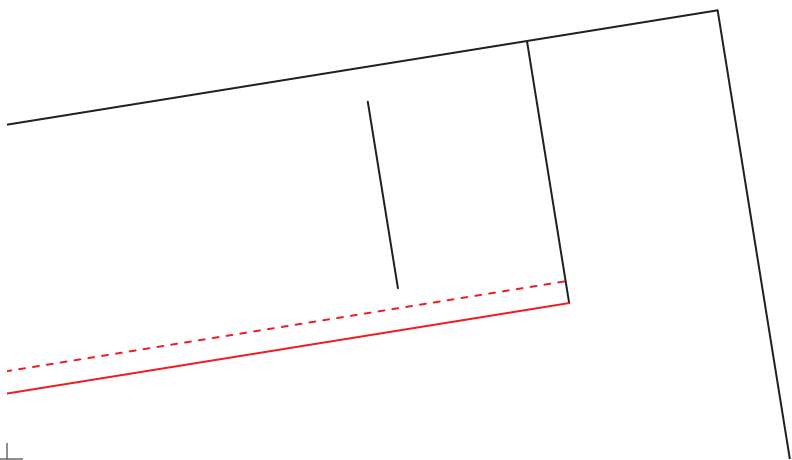

12

WING

16)

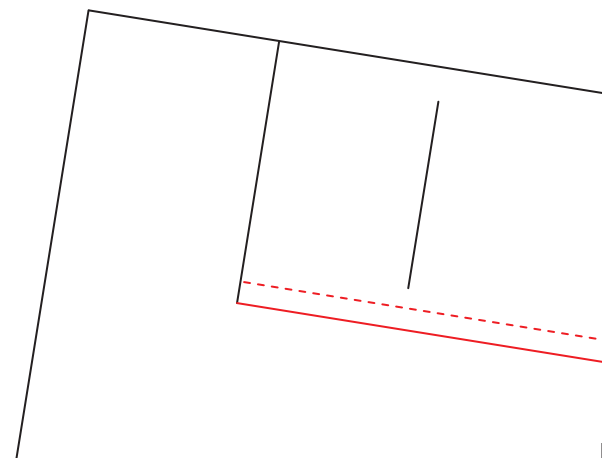



FOAM BOARD SHEET SIZE: 1000 x 700 x 3 mm
SHEET 2 OF 2

SIDE VIEW OF THE WING



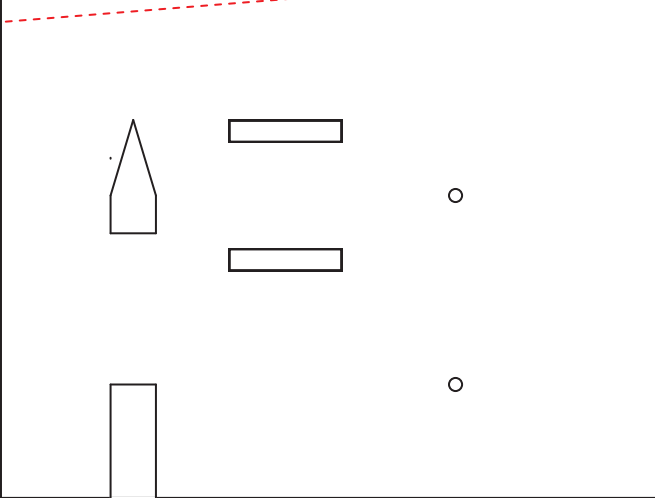
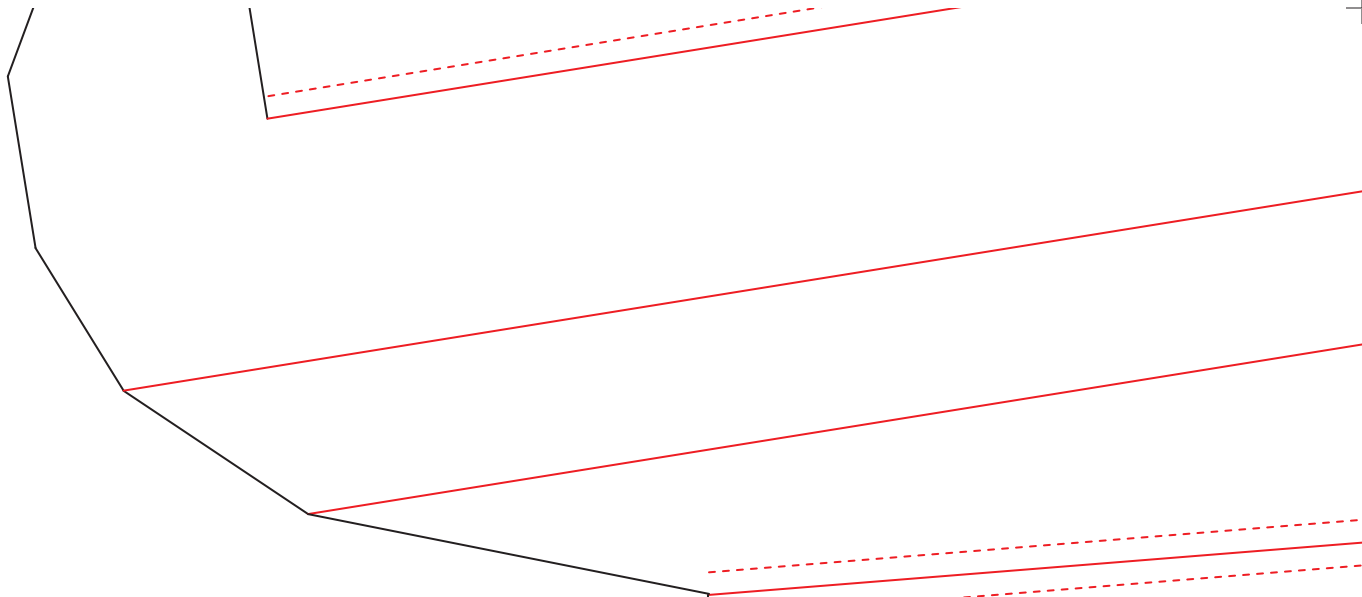

13 WING (LEFT SPACER)

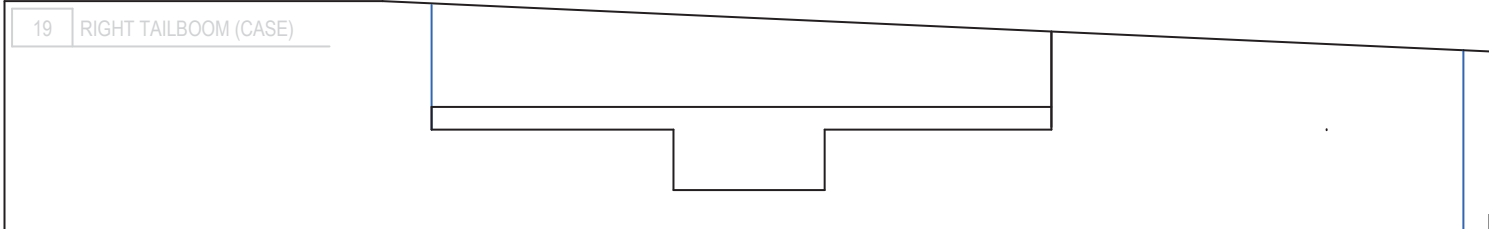

19 RIGHT TAILBOOM (CASE)

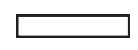
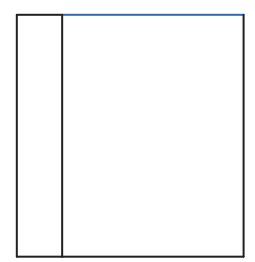
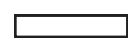
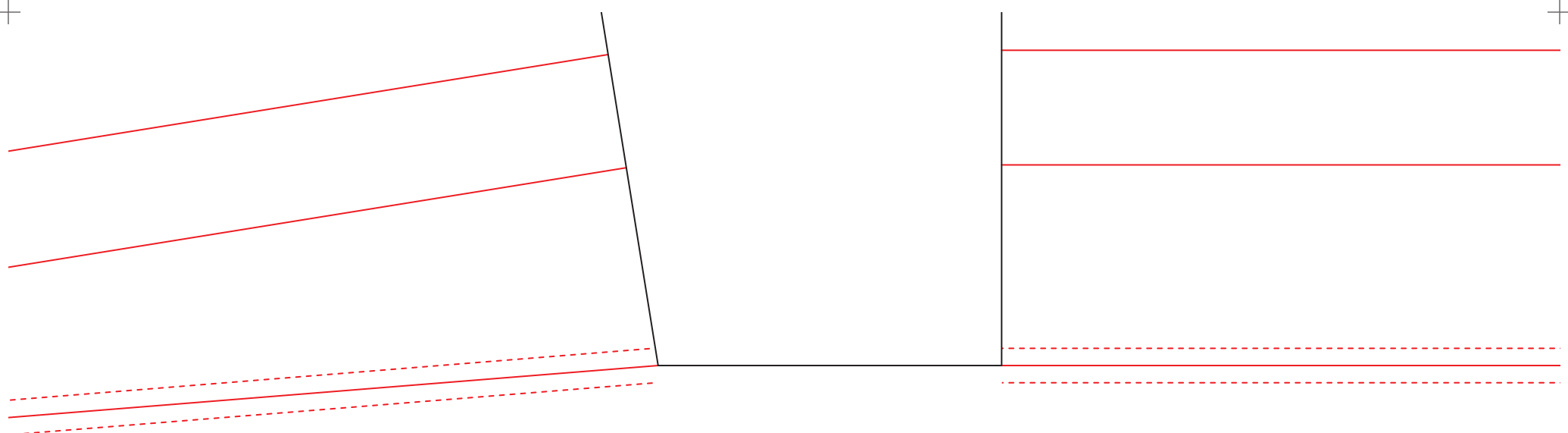

14 WING (MIDDLE SPACER)

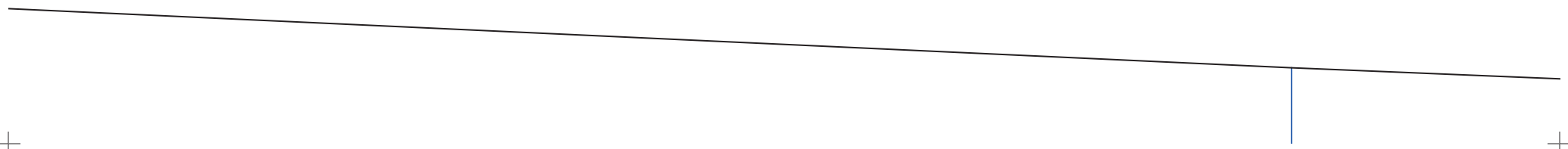

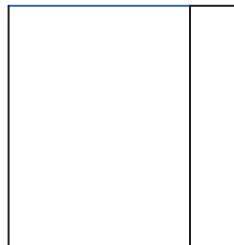
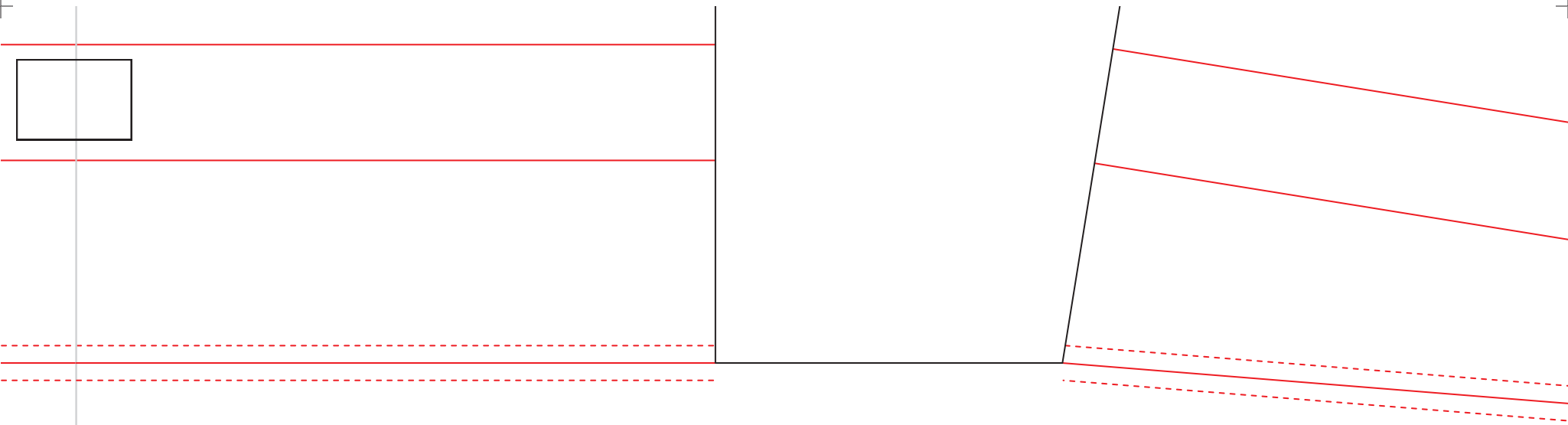

15 WING (RIGHT SPACER)

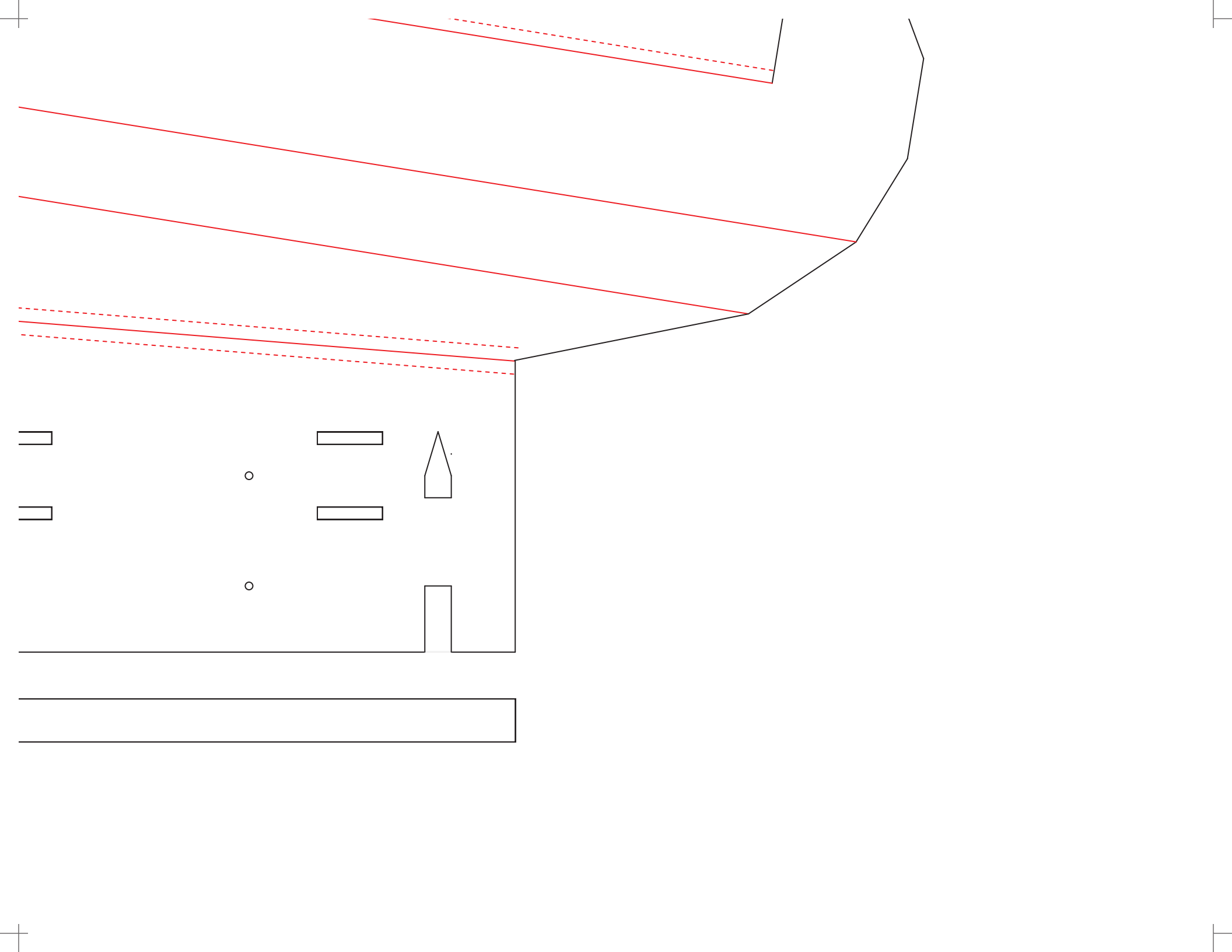

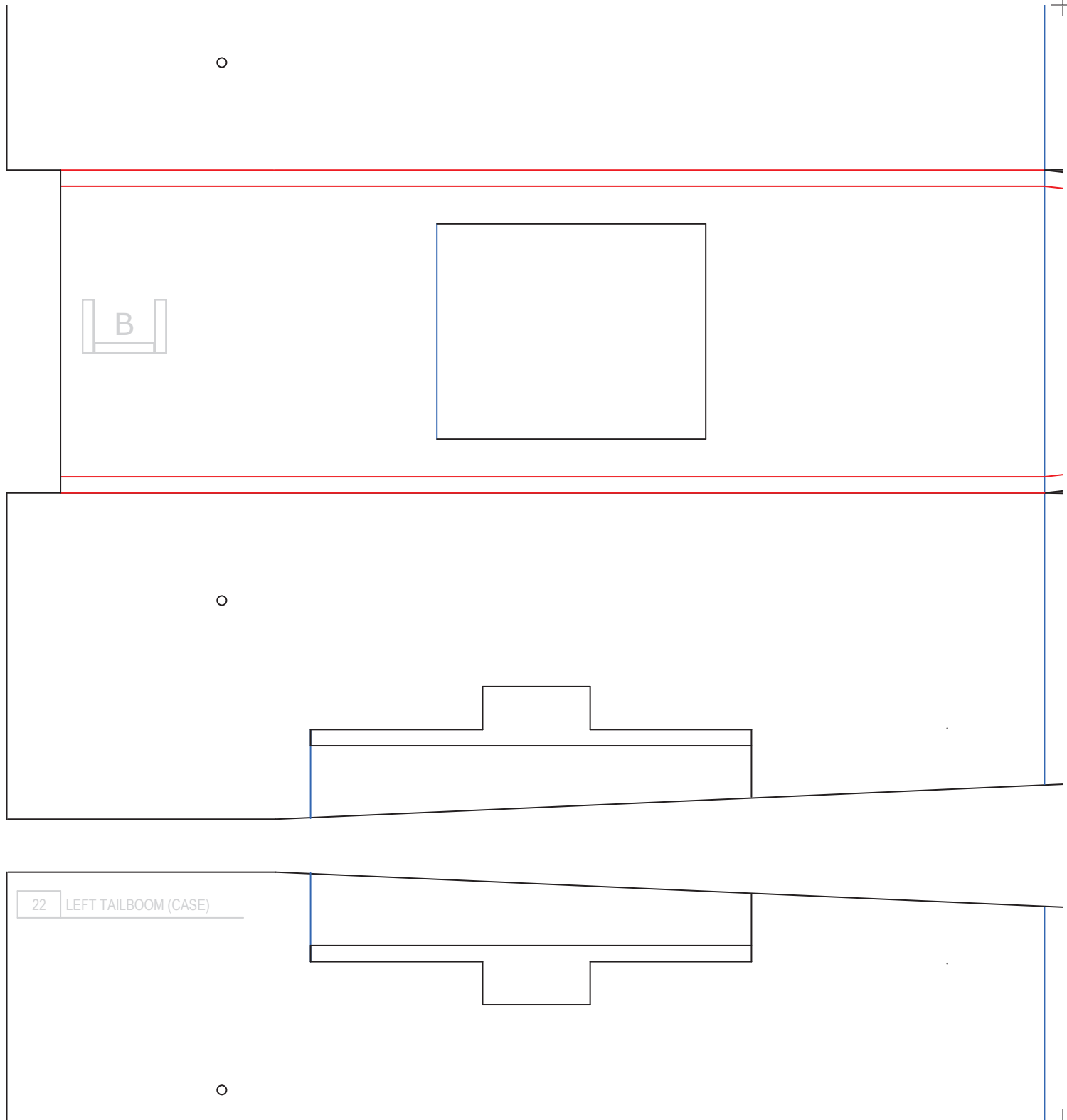

ELEVATOR
SERVO

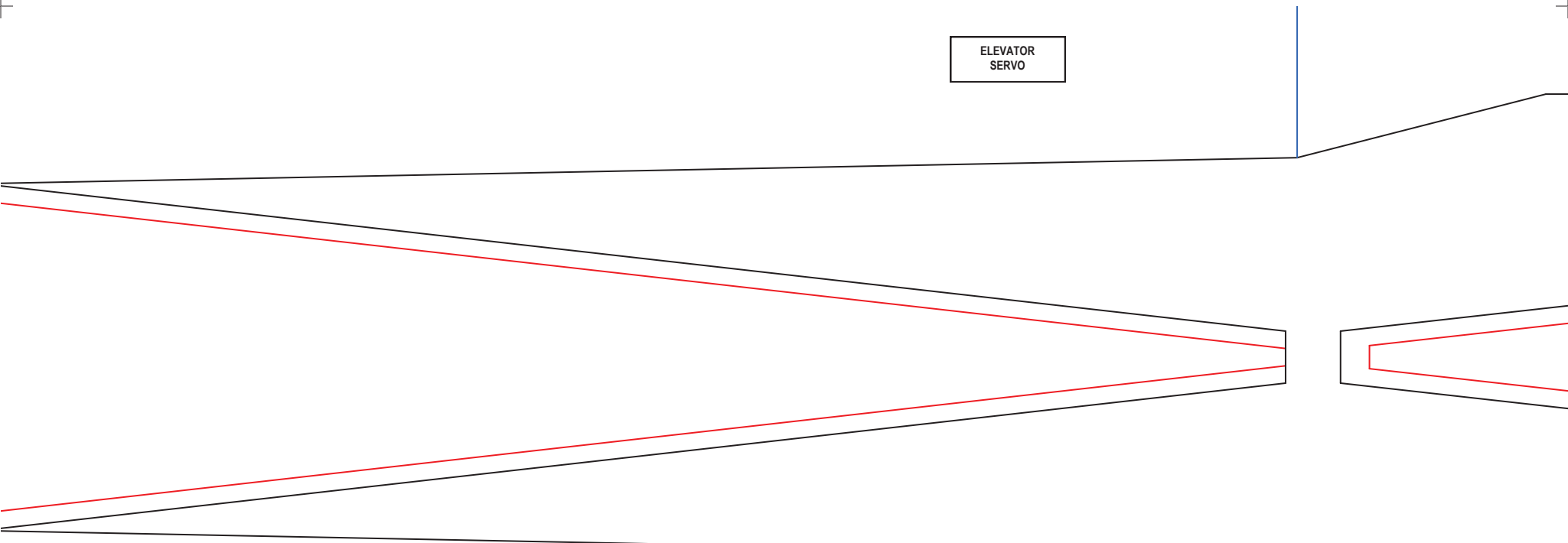

RUDDER
SERVO

INSIDE ELEVATOR
SERVO

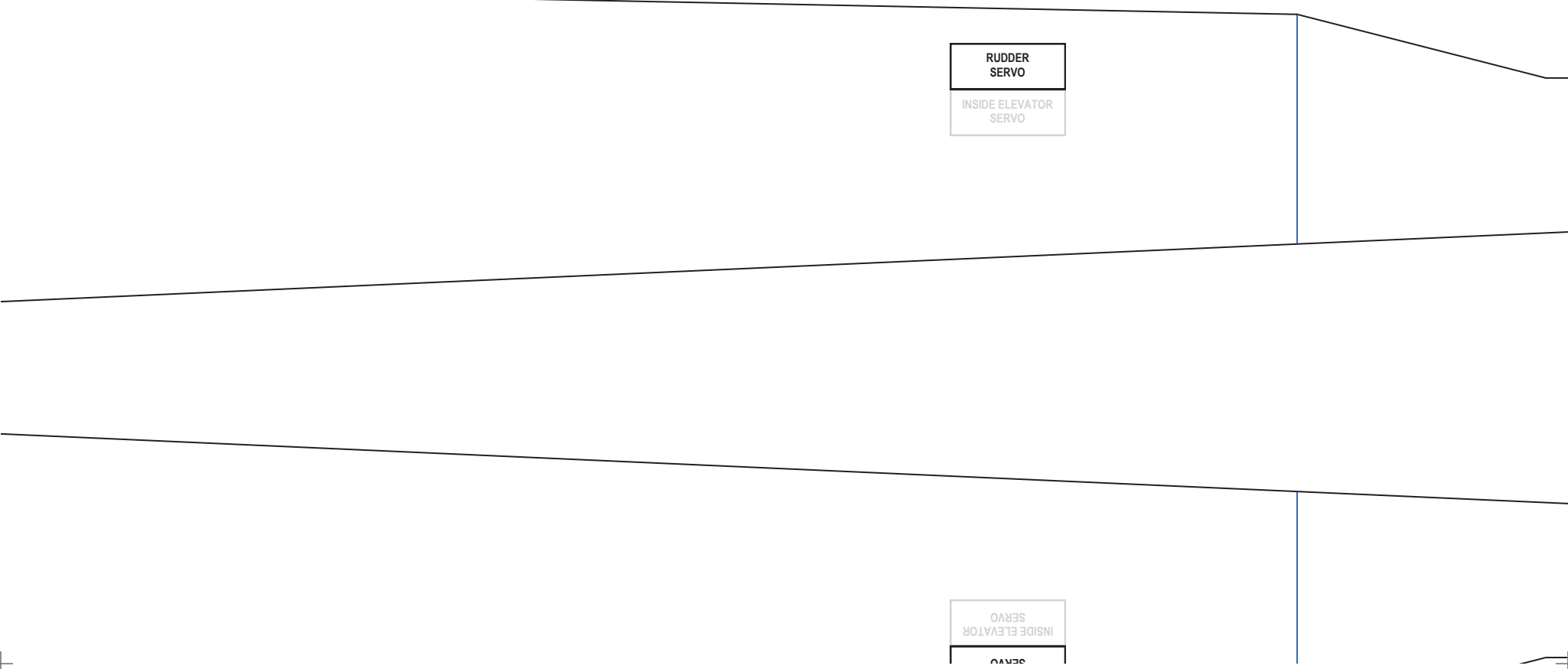

INSIDE ELEVATOR
SERVO

SERVO



20 TAILBOOM (COVER STOPPER)

21 RIGHT TAILBOOM (LOWER COVER)



16 WING (LEFT SPAR)

B

17 WING (MIDDLE SPAR)

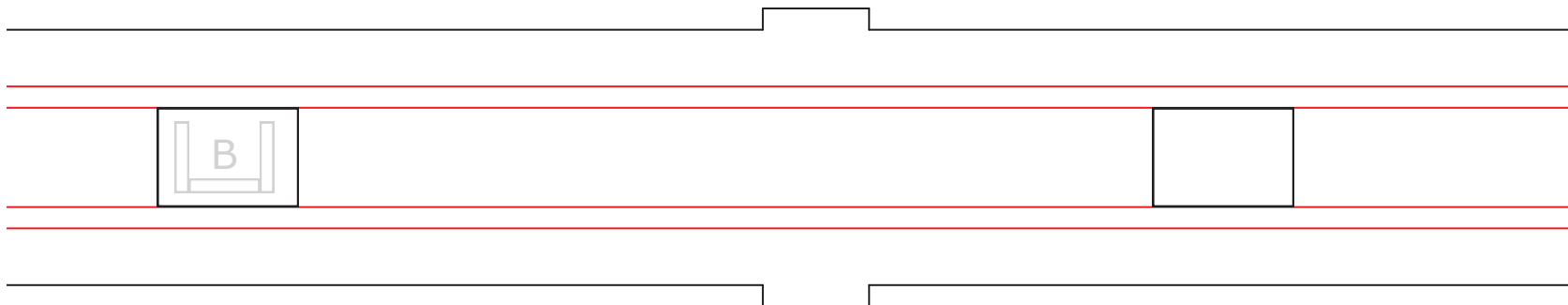
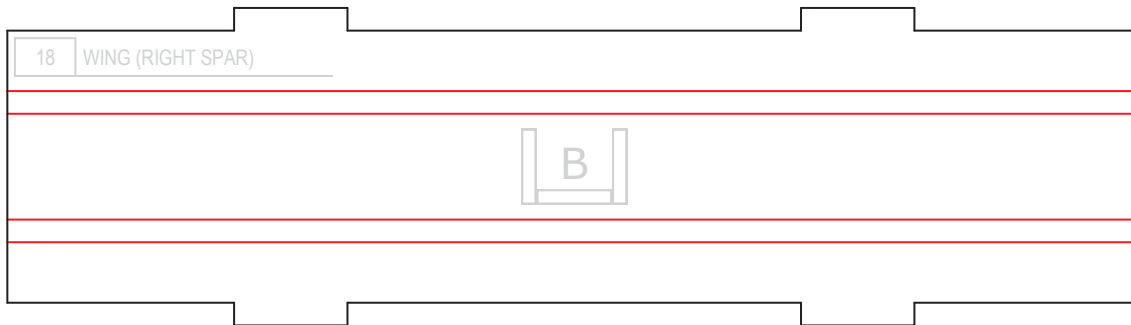
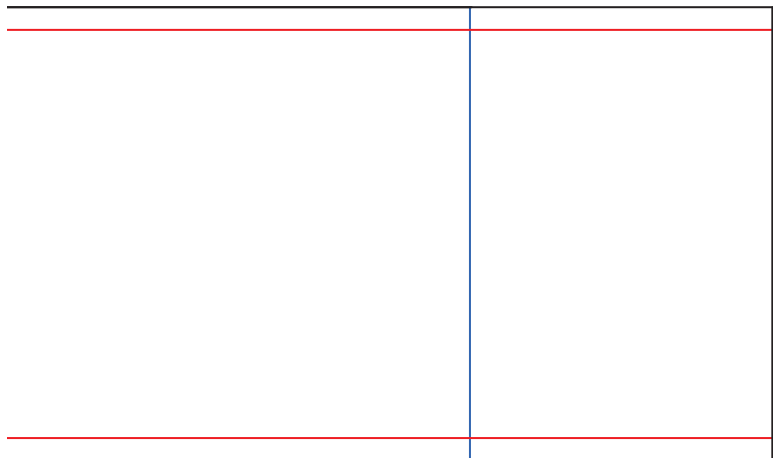

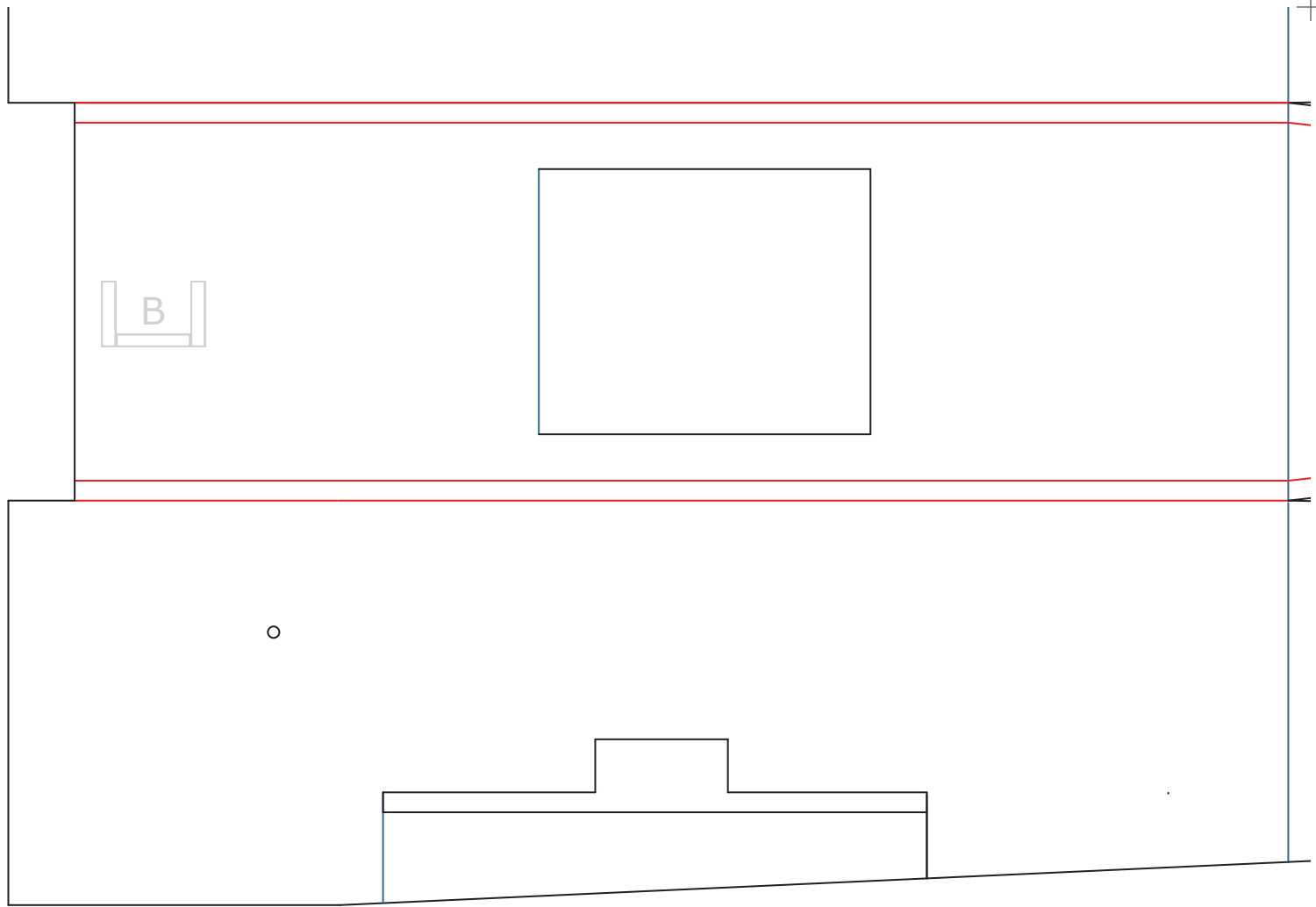

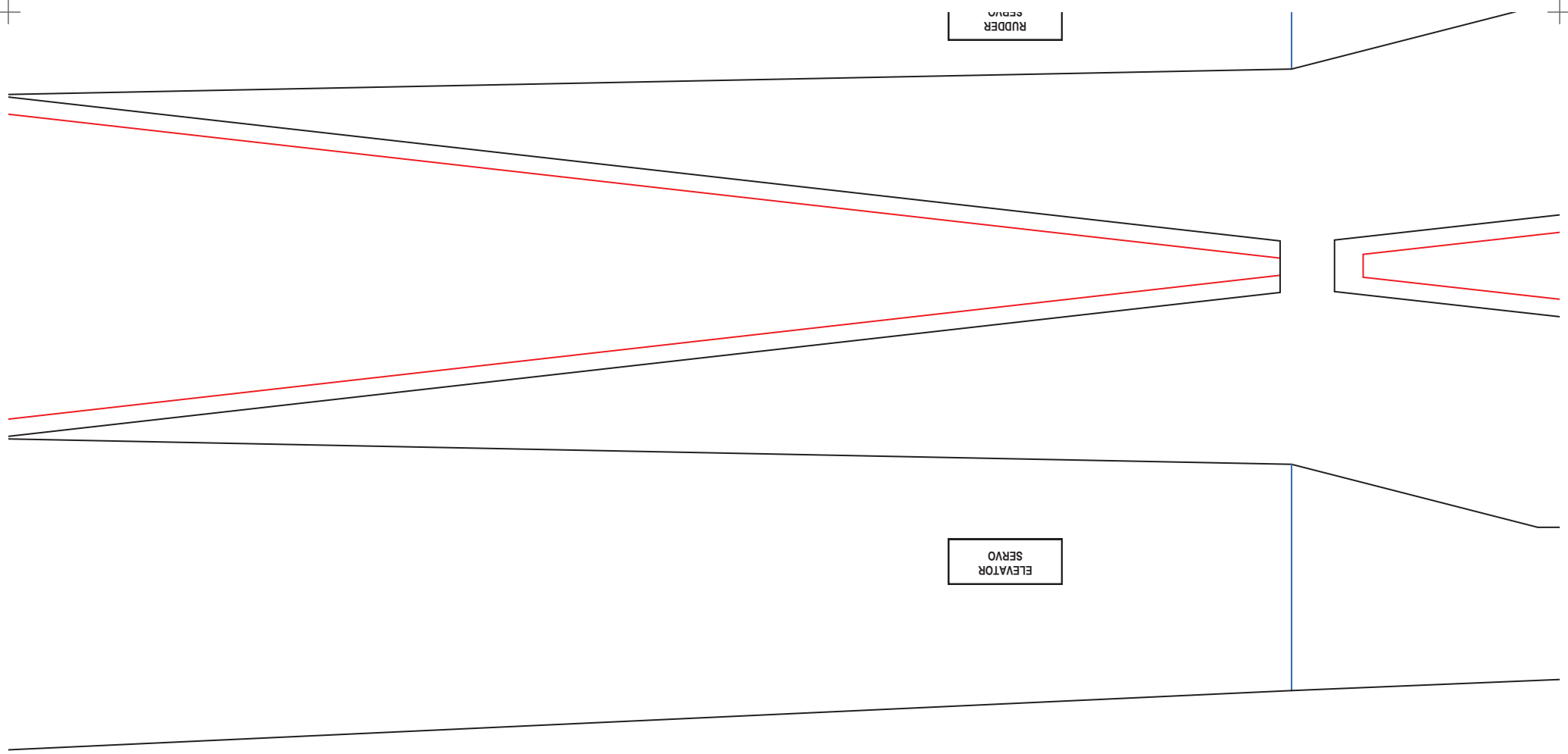

RUDDER
SERVO

ELEVATOR
SERVO

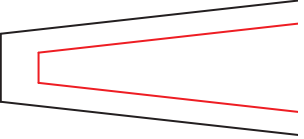

23 TAILBOOM (COVER STOPPER)

24 LEFT TAILBOOM (LOWER COVER)

