



airc-pirates.com

AP Sperber

... Mini Sport Glider

Version 2.1 (2018-09-26)

Desing and Drawing by: Tony Roehling

SPECS

WINGSPAN: 800 mm | 31.50 in
CG: 30 mm | 1.18 in
LENGTH: 575 mm | 22.64 in
EXPO: 30 %
CHANNELS: 4 (THR | AIL | ELV | RUD)

RECOMMENDED ELECTRONICS

MOTOR: 2300 kv (1806)
PROPELLER: 6x4 or 5.5
ESC: 12 A
SERVOS: 4 x 5 g
BATTERY: 850 mAh 3s

BETA



DRAWING KEY

... based on the Flite Test Drawing Key created by Dan Sponholz

FOLD TYPES

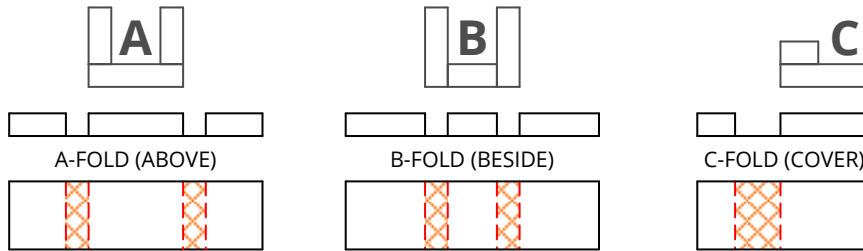

LINE TYPE/COLOR

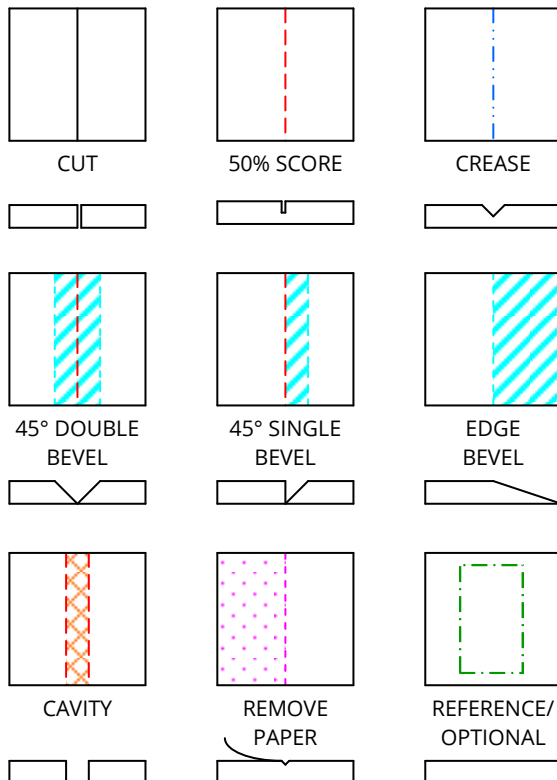

SYMBOLS

PART NUMBER

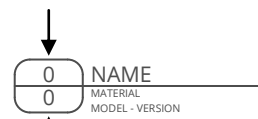

QUANTITY



DOWEL HOLE



CENTER OF GRAVITY (CG)

BETA

AP Sperber

PARTS LIST

Version 2.1 (2018-09-26)

PART NR.	DESCRIPTION	QUANTITY	MATERIAL	SHEET
G1	THROW GAUGE	1	FOAM BOARD	1
1	FUSELAGE	1	FOAM BOARD	1
2	SUPPORT	2	FOAM BOARD	1
3	POWER POD SUPPORT	1	FOAM BOARD	1
4	UPPER WINDOW	1	FOAM BOARD	1
5	LEFT WINDOW	1	FOAM BOARD	1
6	RIGHT WINDOW	1	FOAM BOARD	1
7	CANOPY FRONT MOUNT	1	FOAM BOARD	1
8	HORIZONTAL STABILIZER	1	FOAM BOARD	1
9	VERTICAL STABILIZER	1	FOAM BOARD	1
10	SKID	1	BBQ SKEWER	1
11	LEFT WING PANEL	1	FOAM BOARD	1
12	RIGHT WING PANEL	1	FOAM BOARD	1
13	MIDDLE SPAR	1	FOAM BOARD	1
14	OUTER SPAR	2	FOAM BOARD	1
15	POWER POD PIN	2	BBQ SKEWER	1
16	CANOPY MOUNT PIN	1	BBQ SKEWER	1
17	CONTROL HORN	4	PLASTIC CARD	1
FT1	FT MINI POWER POD	1	FOAM BOARD	1
FT2	FT MINI FIREWALL	1	PLYWOOD	1
	OTHER MATERIALS			
	STEEL WIRE (Ø 1mm) FOR THE LINKAGE RODS			
	VELCRO TO MOUNT THE BATTERY, ESC, ...			

Build the Sperber in the order of the part numbers!

AP Sperber Mini

Design & Drawing by: Tony Roehling

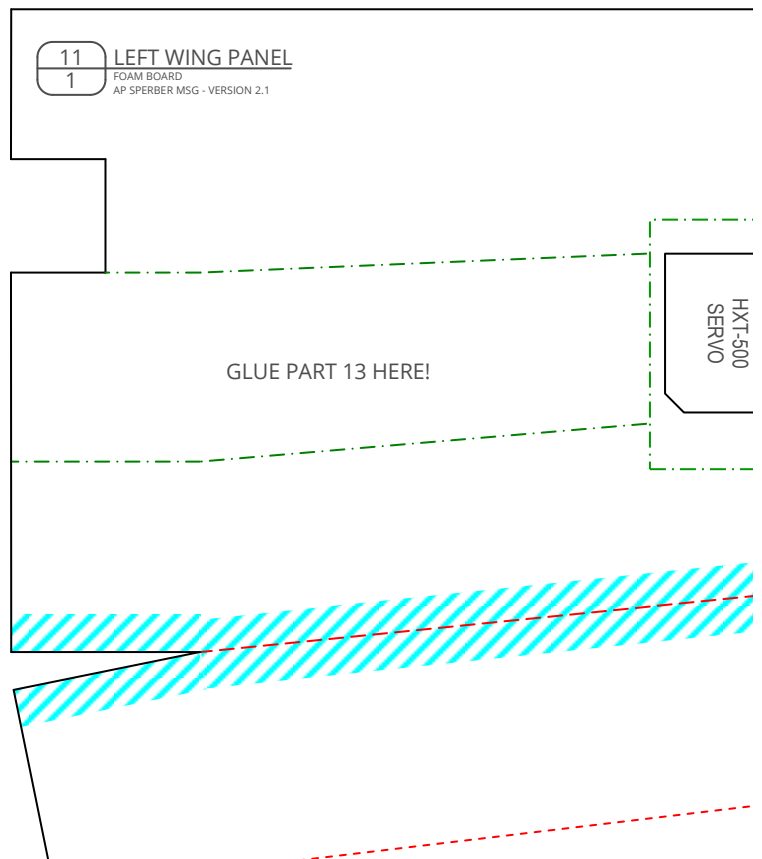

Sport Glider - VERSION 2.1 (201

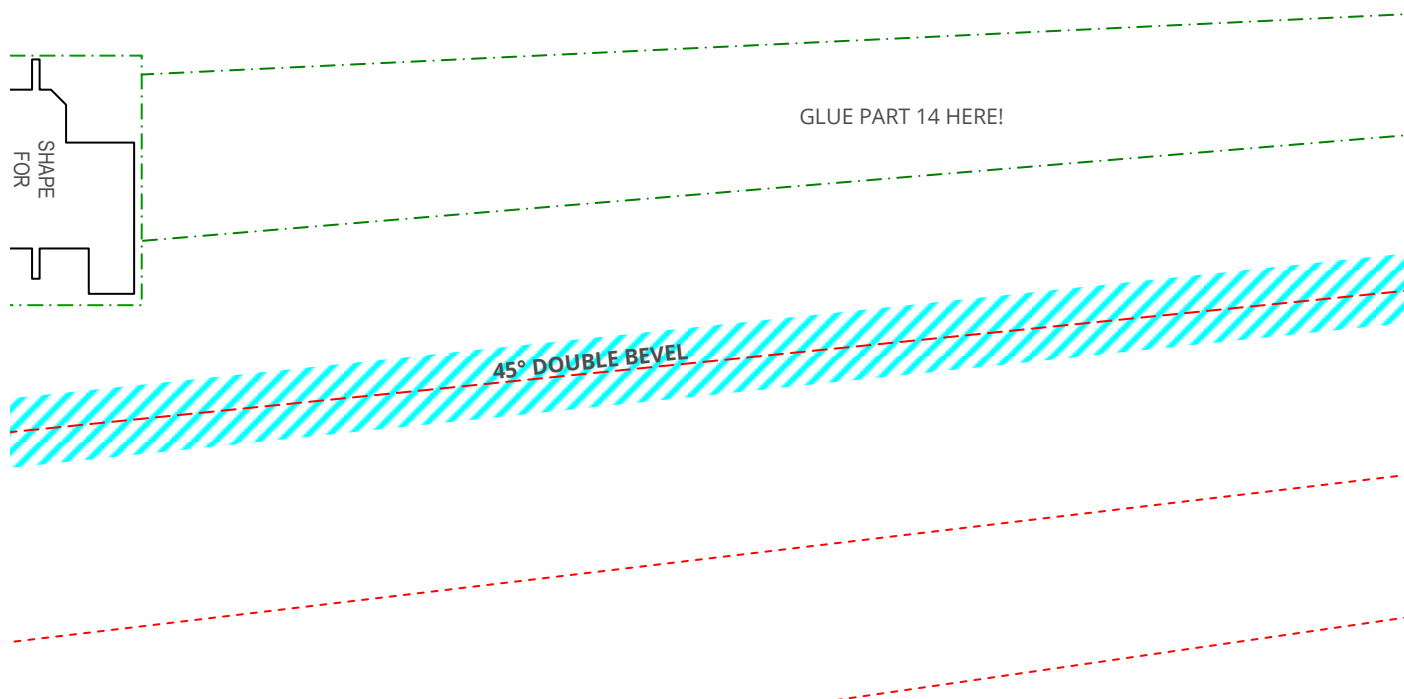

8-09-26)

BETA

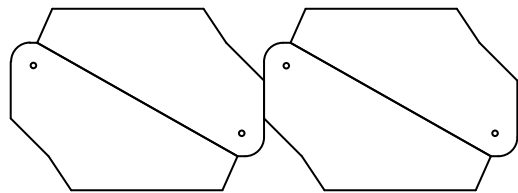

17 CONTROL HORN
4 PLASTIC CARD
AP SPERBER MSG - VERSION 2.1

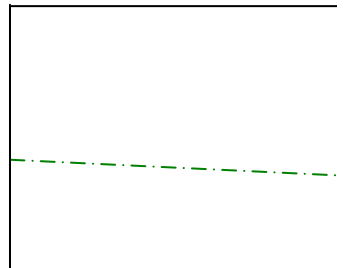
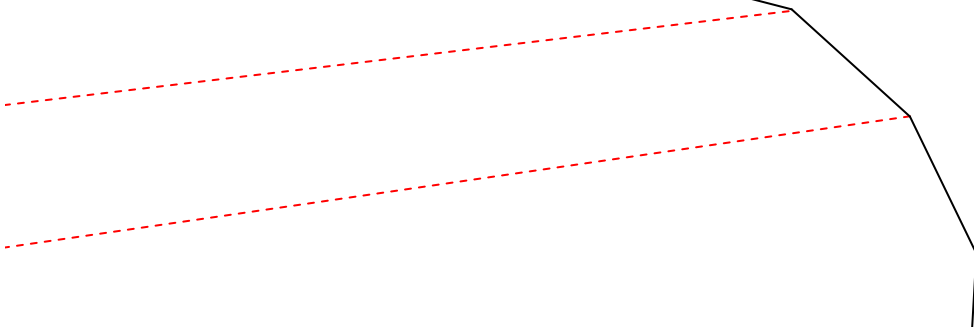
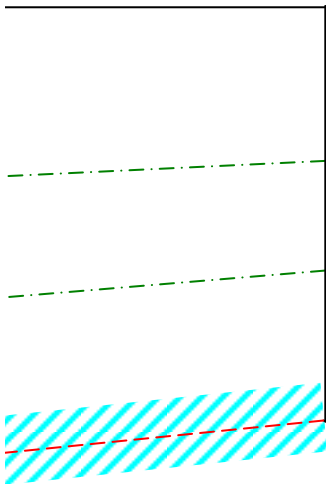

in
cm

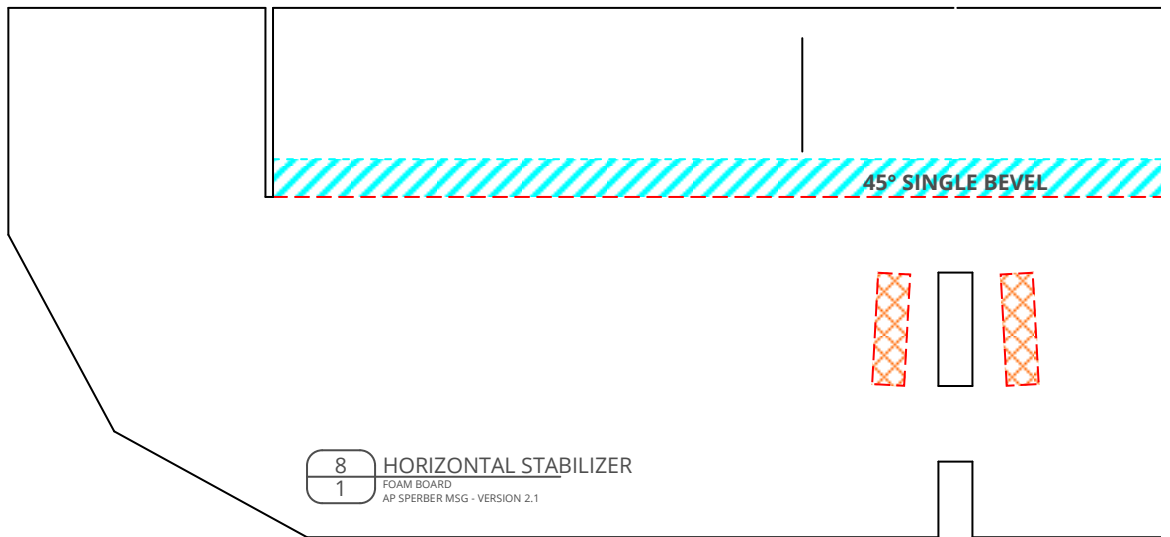

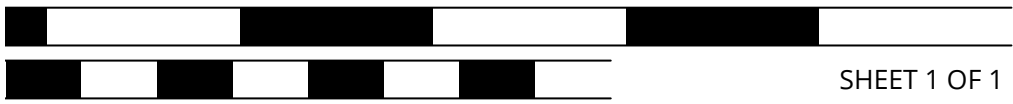

SHEET 1 OF 1

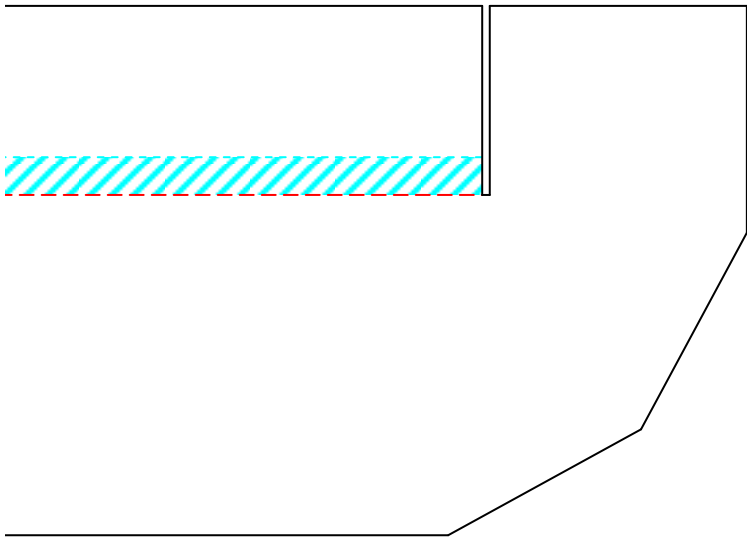

12 RIGHT WING PANEL
1 FOAM BOARD
AP SPERBER MSG - VERSION 2.1



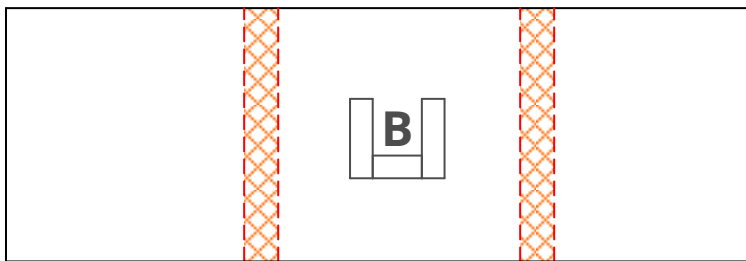
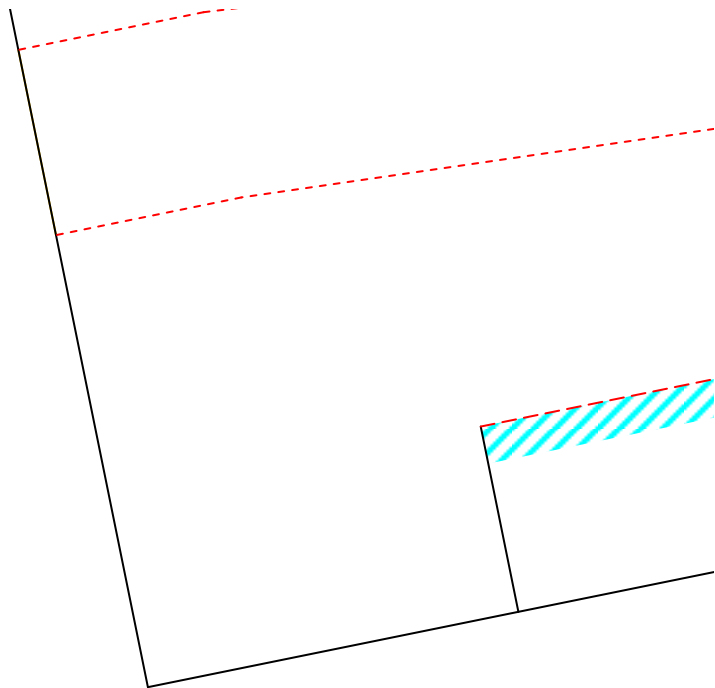

3
1 POWER POD SUPPORT
FOAM BOARD
AP SPERBER MSG - VERSION 2.1

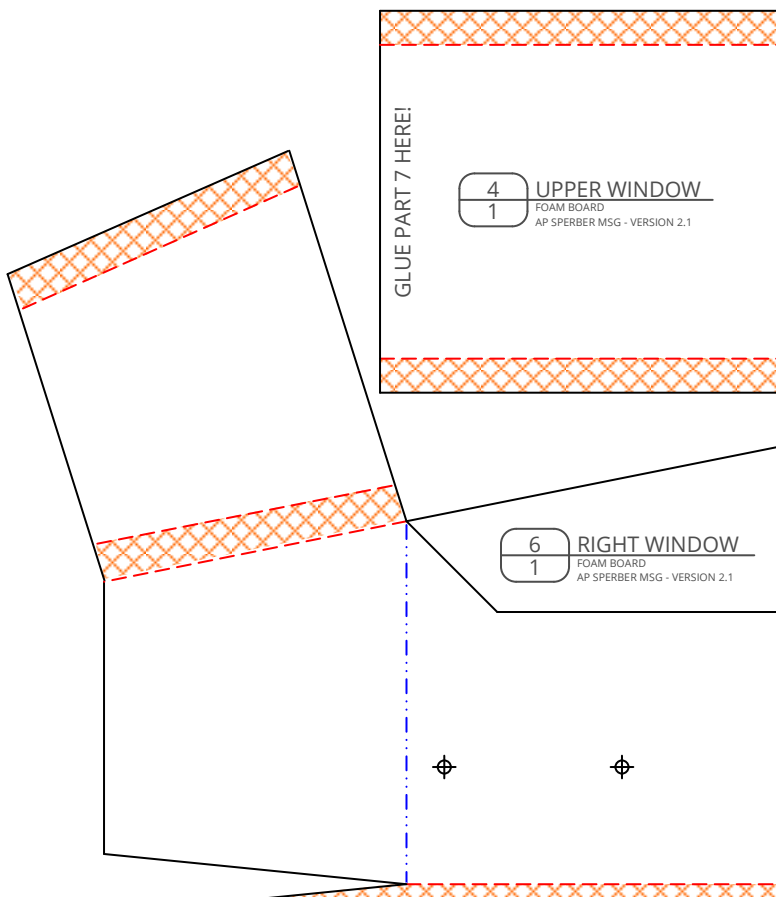

4
1 UPPER WINDOW
FOAM BOARD
AP SPERBER MSG - VERSION 2.1

6
1 RIGHT WINDOW
FOAM BOARD
AP SPERBER MSG - VERSION 2.1

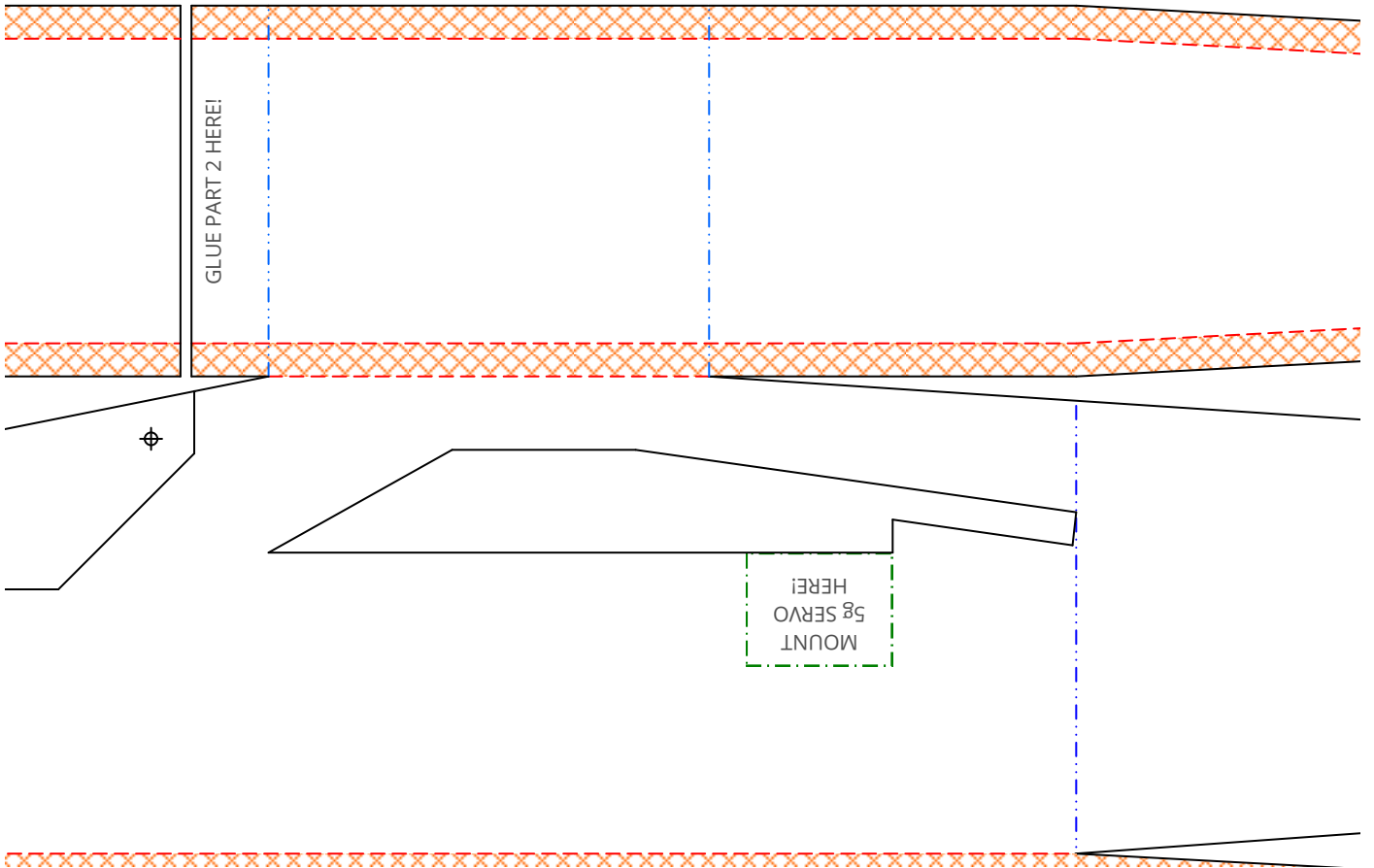
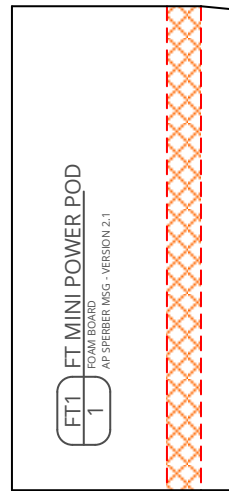
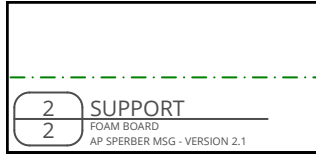
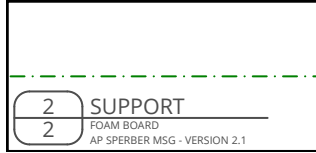
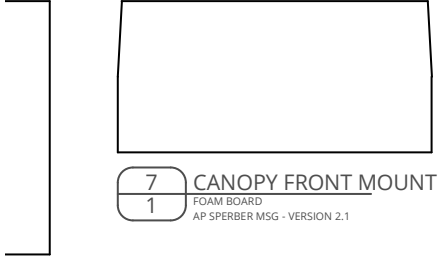
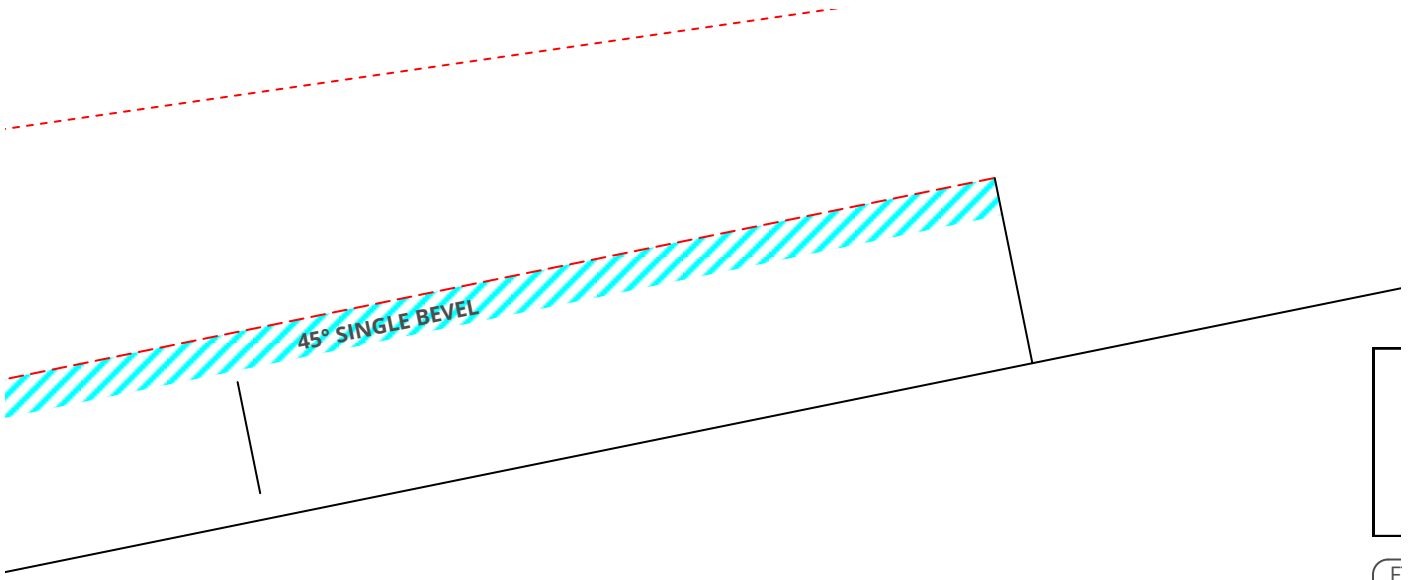

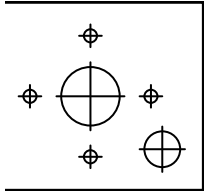

T2 FT MINI FIREWALL
1 PLYWOOD
AP SPERBER MSG - VERSION 2.1

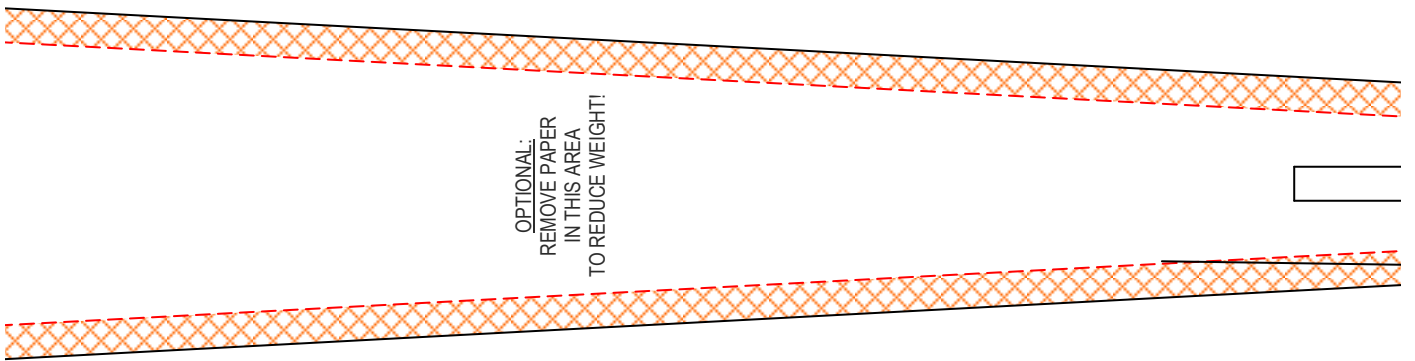
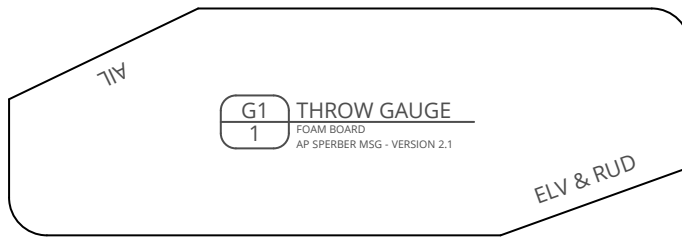
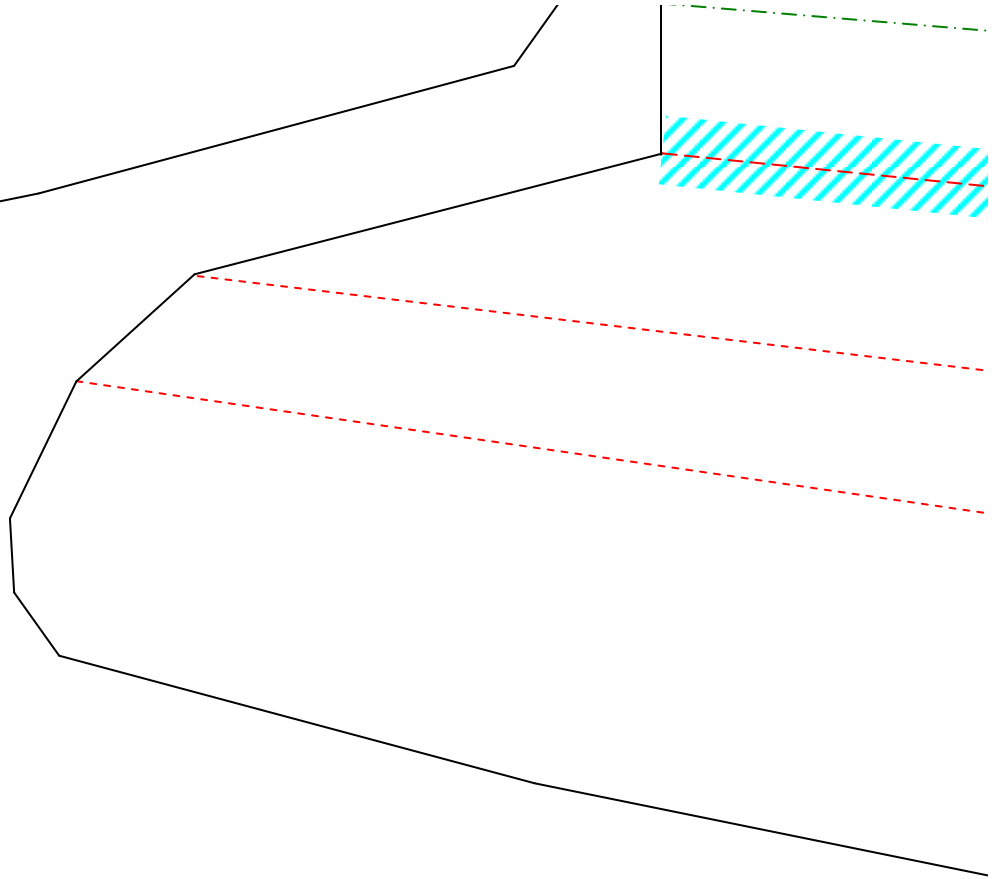
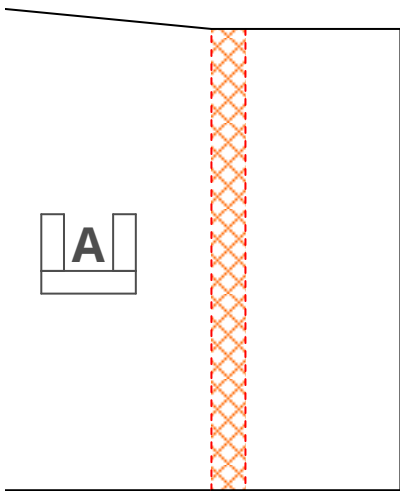

OPTIONAL:
REMOVE PAPER
IN THIS AREA
TO REDUCE WEIGHT!

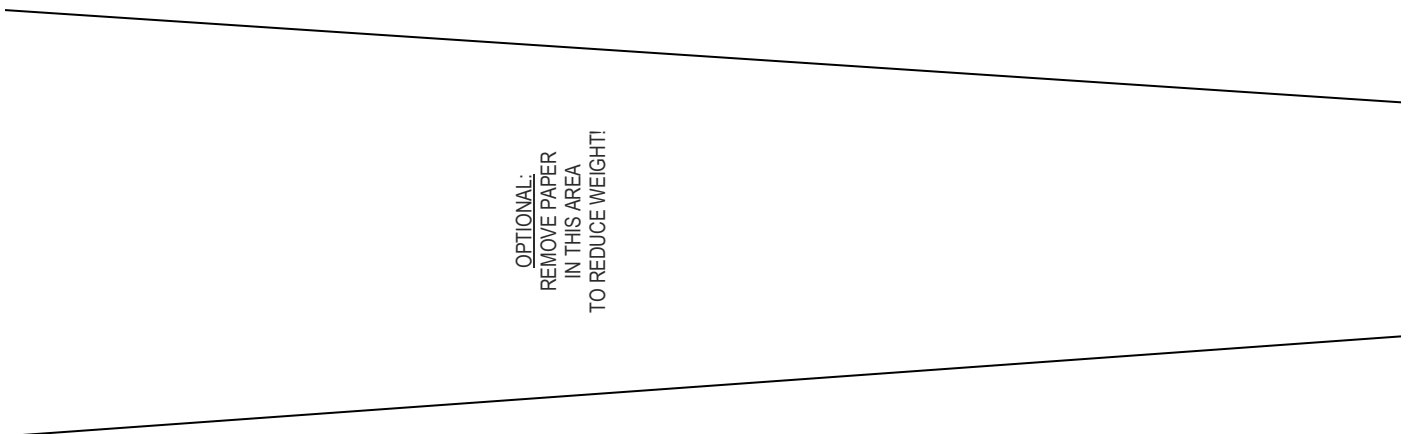

OPTIONAL:
REMOVE PAPER
IN THIS AREA
TO REDUCE WEIGHT!

GLUE PART 14 HERE!

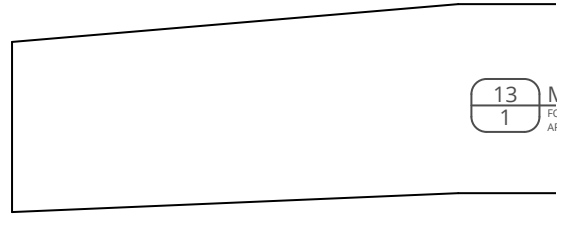
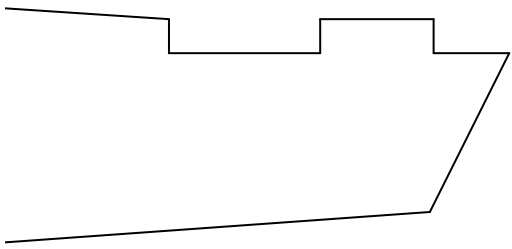
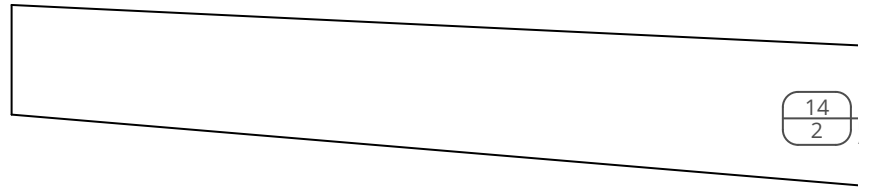
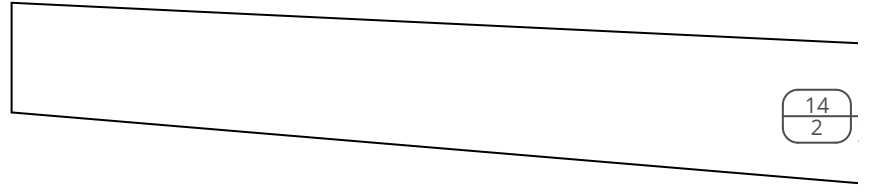
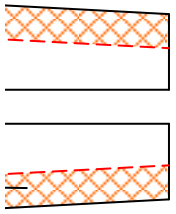
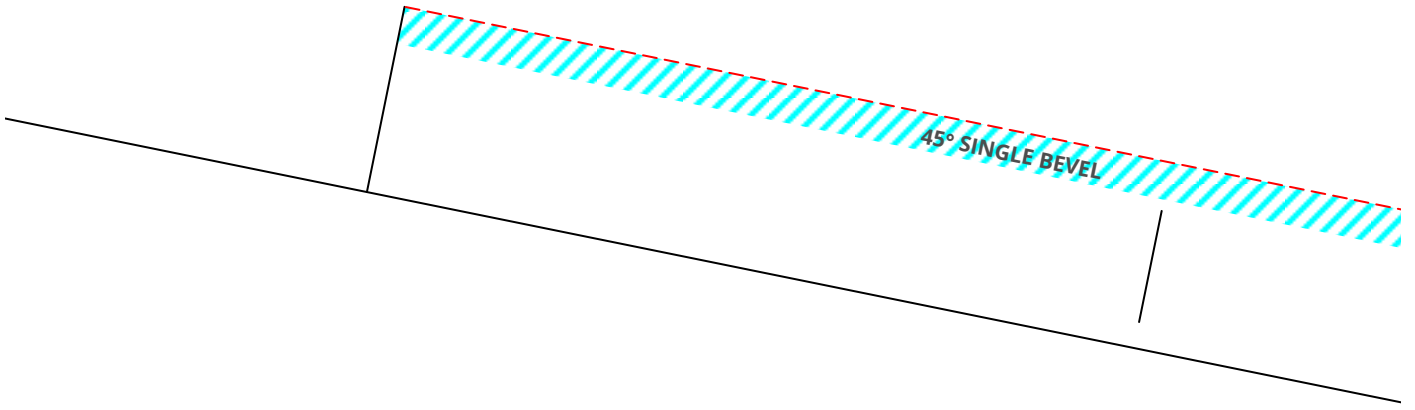
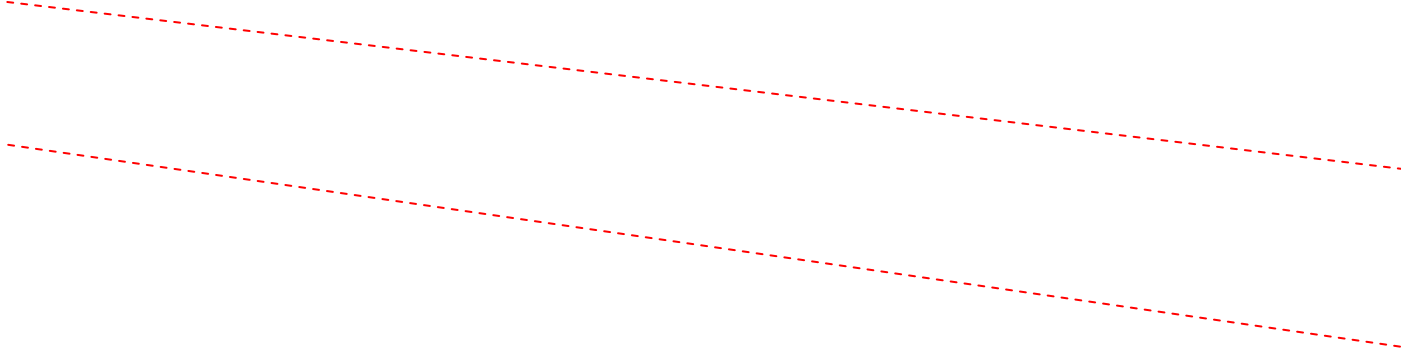
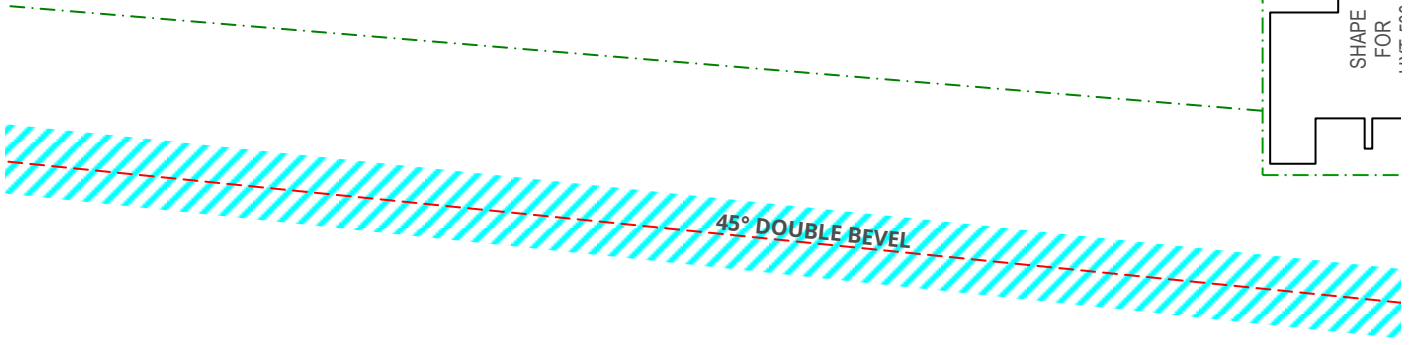
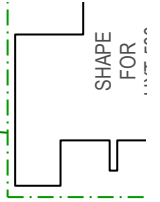

M
FC
AS

HX1-500
SERVO

GLUE PART 13 HERE!

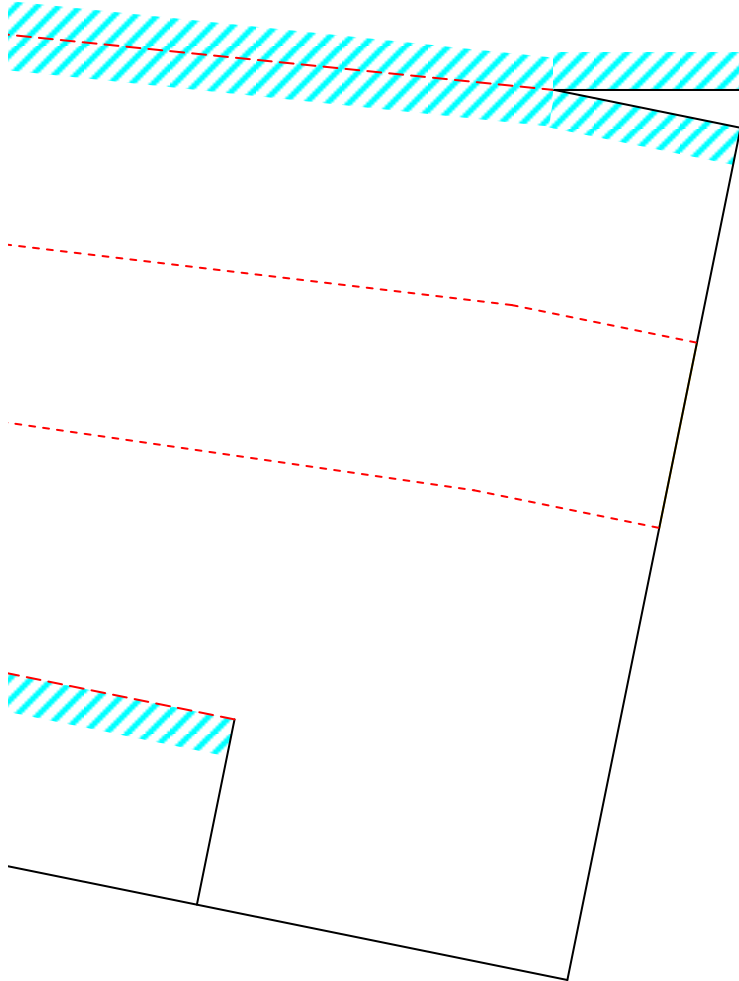

OUTER SPAR

FOAM BOARD
AP SPERBER MSG - VERSION 2.1

OUTER SPAR

FOAM BOARD
AP SPERBER MSG - VERSION 2.1

MIDDLE SPAR

JAM BOARD
AP SPERBER MSG - VERSION 2.1

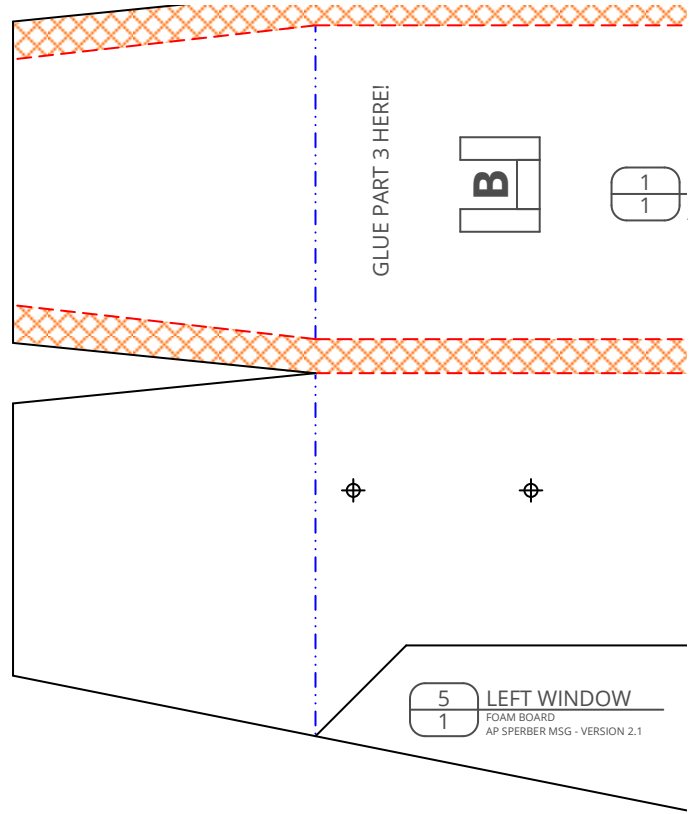

FUSELAGE

FOAM BOARD
AP SPERBER MSG - VERSION 2.1

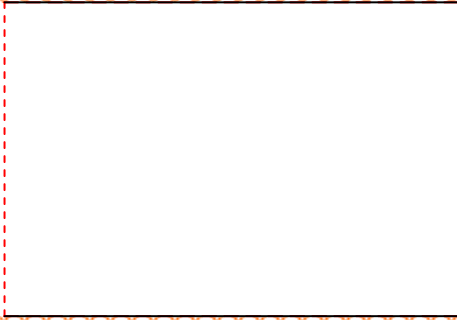

GLUE PART 2 HERE!

MOUNT
5g SERVO
HERE!

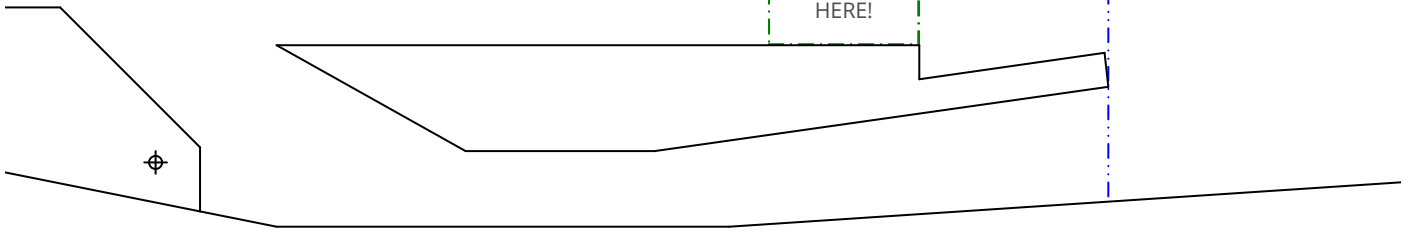

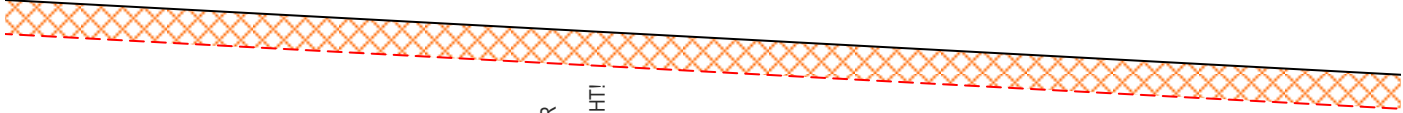

OPTIONAL:
REMOVE PAPER
IN THIS AREA
TO REDUCE WEIGHT!

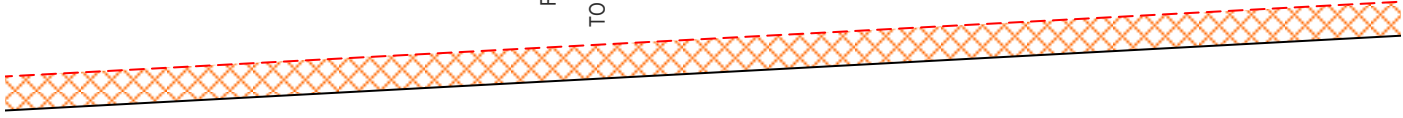

OPTIONAL:
REMOVE PAPER
IN THIS AREA
TO REDUCE WEIGHT!



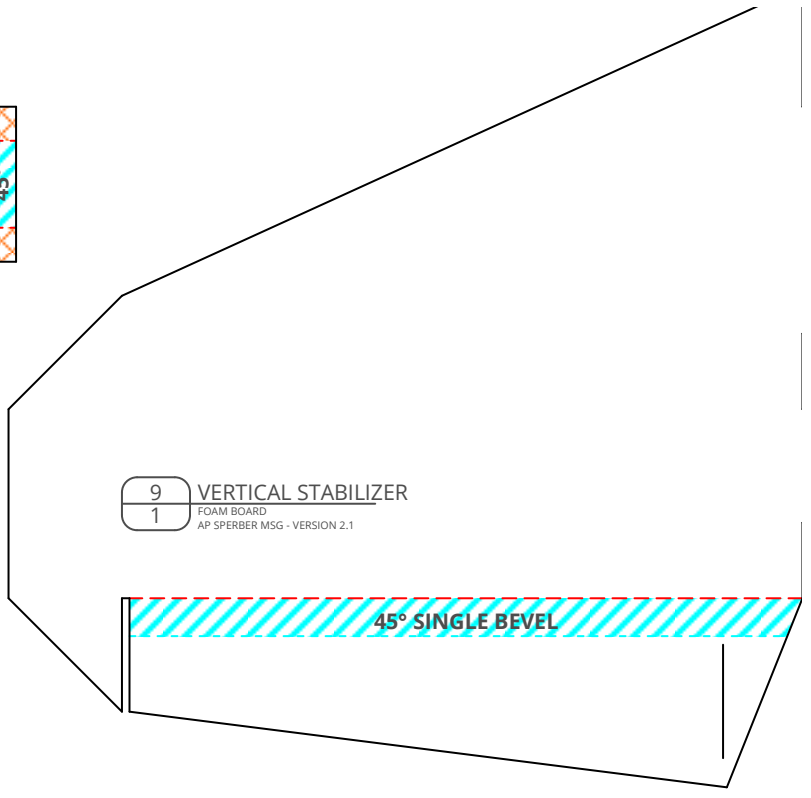
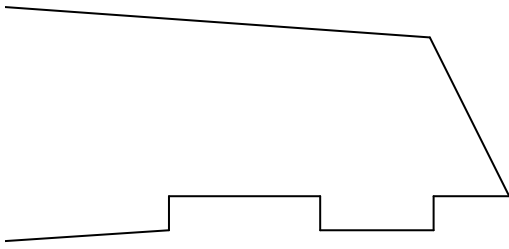
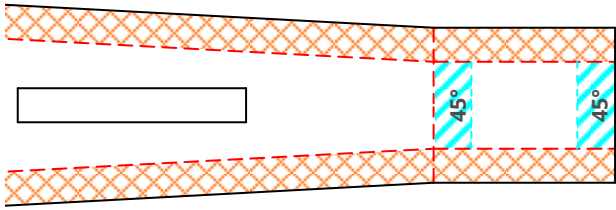

9 VERTICAL STABILIZER
1 FOAM BOARD
AP SPERBER MSG - VERSION 2.1

GLUE PART 10 HERE!



16 CANOPY MOUNT PIN
BBQ-SKEWER
AP SPERBER MSG - VERSION 2.1



15 POWER POD PIN
BBQ-SKEWER
AP SPERBER MSG - VERSION 2.1



10 SKID
BBQ-SKEWER
AP SPERBER MSG - VERSION 2.1

vided free of charge. Copies allowed for personal use only. Not for commercial use.