



airc-pirates.com

AP Sperber

... Mini Sport Glider

Version 2.1 (2018-09-26)

Desing and Drawing by: Tony Roehling

SPECS

WINGSPAN: 800 mm | 31.50 in
CG: 30 mm | 1.18 in
LENGTH: 575 mm | 22.64 in
EXPO: 30 %
CHANNELS: 4 (THR | AIL | ELV | RUD)

RECOMMENDED ELECTRONICS

MOTOR: 2300 kv (1806)
PROPELLER: 6x4 or 5.5
ESC: 12 A
SERVOS: 4 x 5 g
BATTERY: 850 mAh 3s

BETA



DRAWING KEY

... based on the Flite Test Drawing Key created by Dan Sponholz

FOLD TYPES

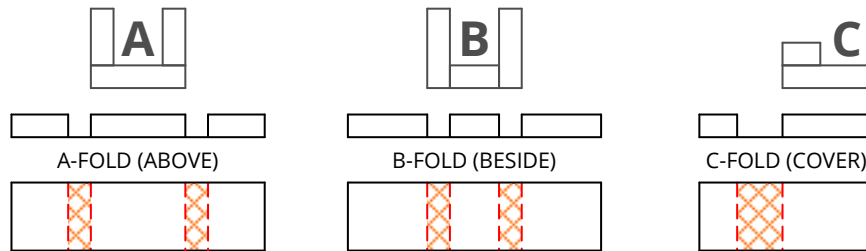

LINE TYPE/COLOR

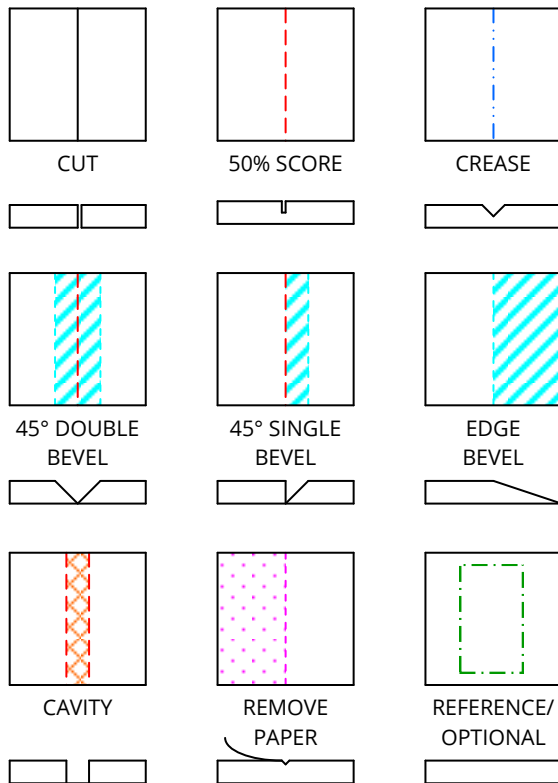

SYMBOLS

PART NUMBER

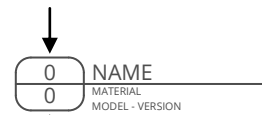

QUANTITY



DOWEL HOLE



CENTER OF GRAVITY (CG)

BETA

AP Sperber

PARTS LIST

Version 2.1 (2018-09-26)

PART NR.	DESCRIPTION	QUANTITY	MATERIAL	SHEET
G1	THROW GAUGE	1	FOAM BOARD	1
1	FUSELAGE	1	FOAM BOARD	1
2	SUPPORT	2	FOAM BOARD	1
3	POWER POD SUPPORT	1	FOAM BOARD	1
4	UPPER WINDOW	1	FOAM BOARD	1
5	LEFT WINDOW	1	FOAM BOARD	1
6	RIGHT WINDOW	1	FOAM BOARD	1
7	CANOPY FRONT MOUNT	1	FOAM BOARD	1
8	HORIZONTAL STABILIZER	1	FOAM BOARD	1
9	VERTICAL STABILIZER	1	FOAM BOARD	1
10	SKID	1	BBQ SKEWER	1
11	LEFT WING PANEL	1	FOAM BOARD	1
12	RIGHT WING PANEL	1	FOAM BOARD	1
13	MIDDLE SPAR	1	FOAM BOARD	1
14	OUTER SPAR	2	FOAM BOARD	1
15	POWER POD PIN	2	BBQ SKEWER	1
16	CANOPY MOUNT PIN	1	BBQ SKEWER	1
17	CONTROL HORN	4	PLASTIC CARD	1
FT1	FT MINI POWER POD	1	FOAM BOARD	1
FT2	FT MINI FIREWALL	1	PLYWOOD	1
	OTHER MATERIALS			
	STEEL WIRE (Ø 1mm) FOR THE LINKAGE RODS			
	VELCRO TO MOUNT THE BATTERY, ESC, ...			

Build the Sperber in the order of the part numbers!

AP Sperber Mir

Design & Drawing by: Tony Roehling

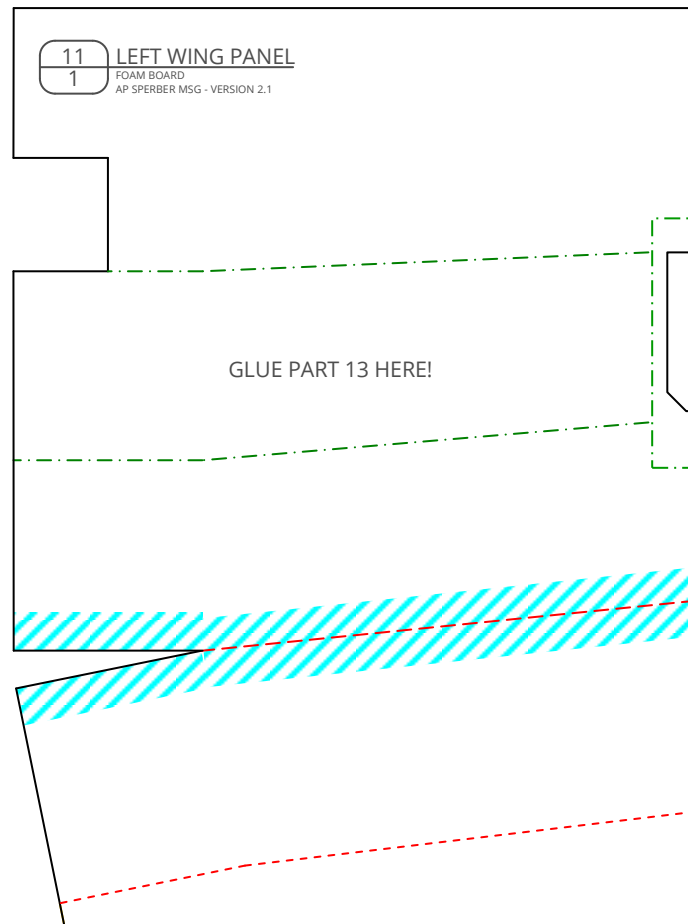

ni Sport Glider - VERSION 2.1 (20'

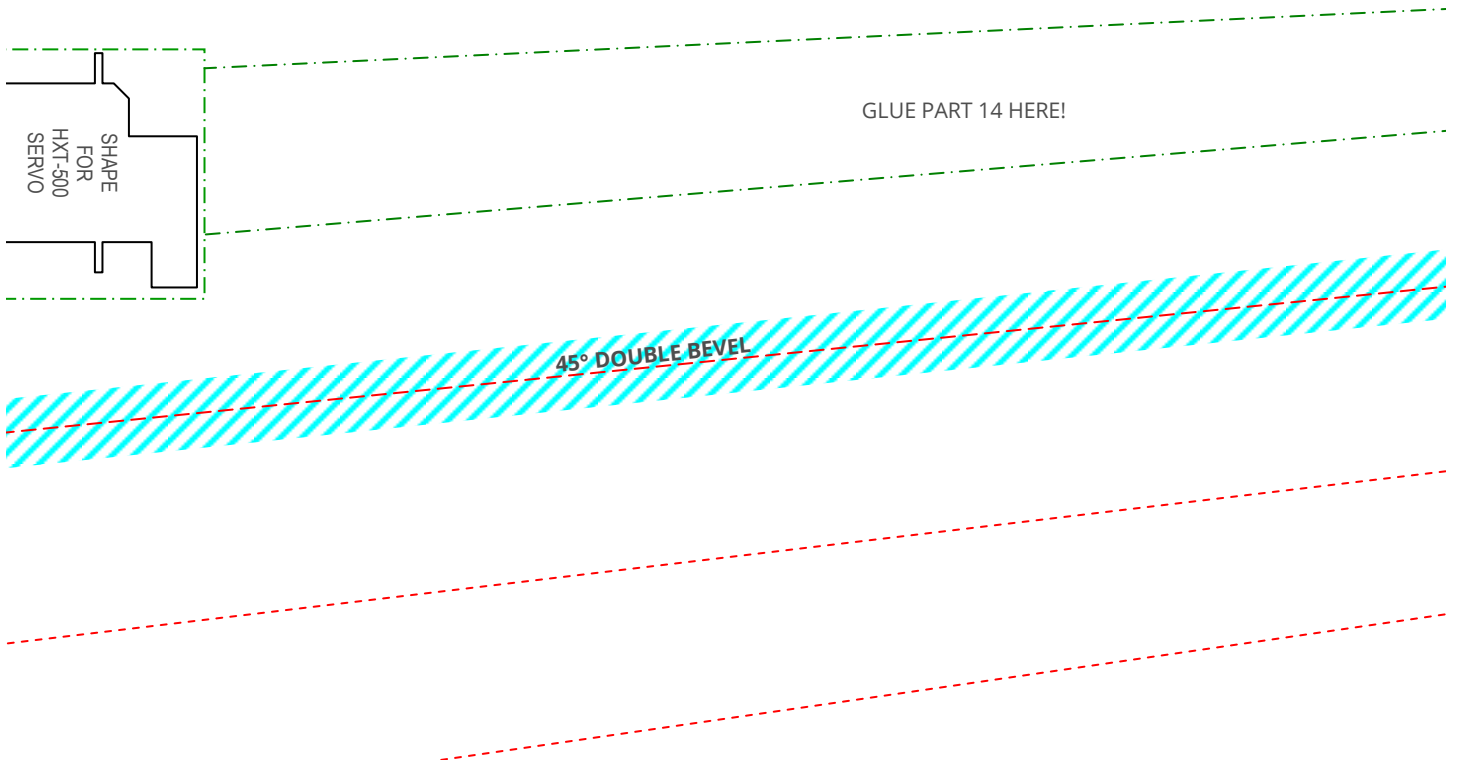

18-09-26)

BETA

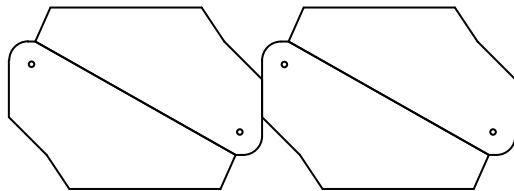

17 CONTROL HORN
4 PLASTIC CARD
AP SPERBER MSG - VERSION 2.1

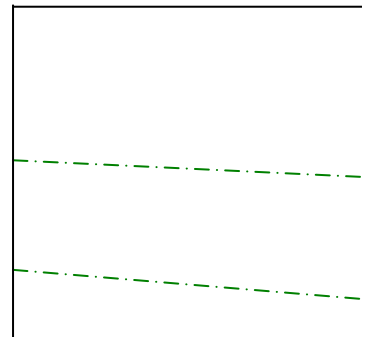
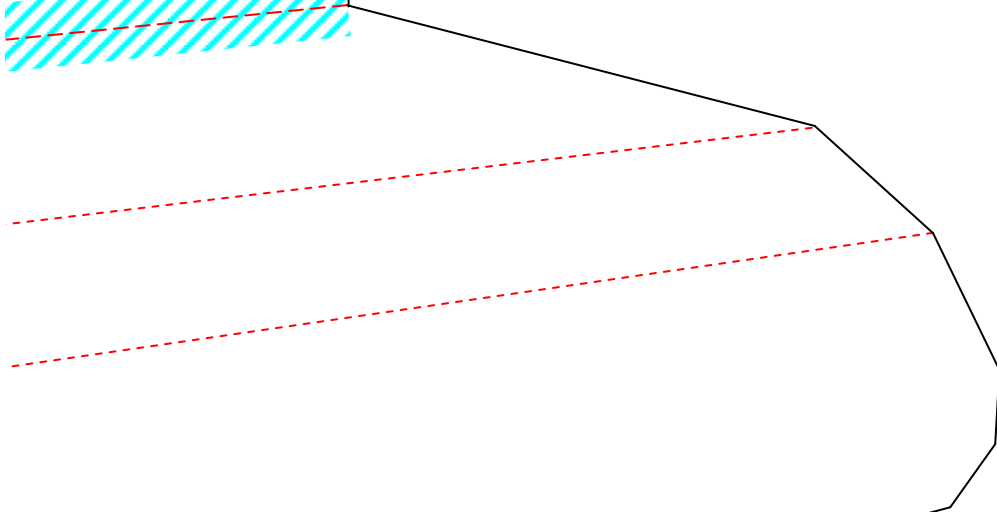
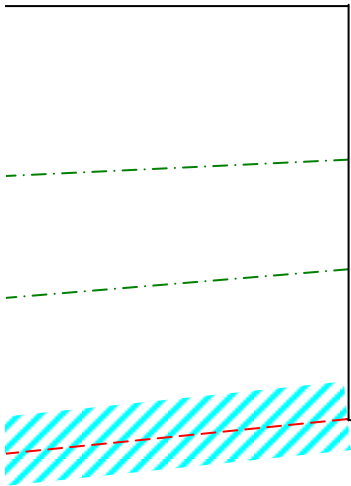

in 
cm 

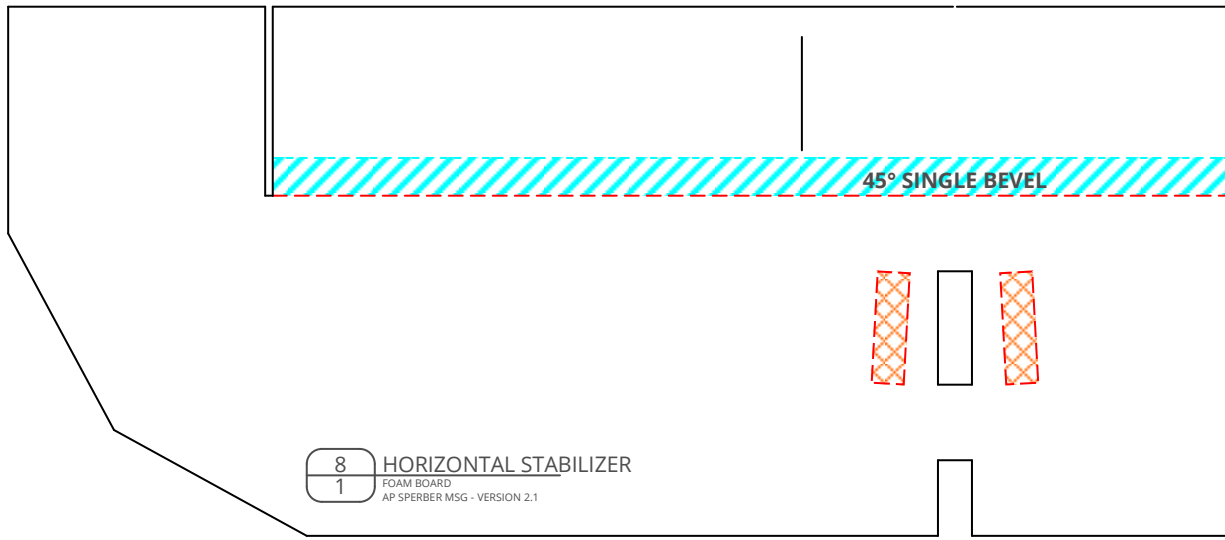

GLUE PART 14 HERE!

IAPE
OR
T-500
RVO

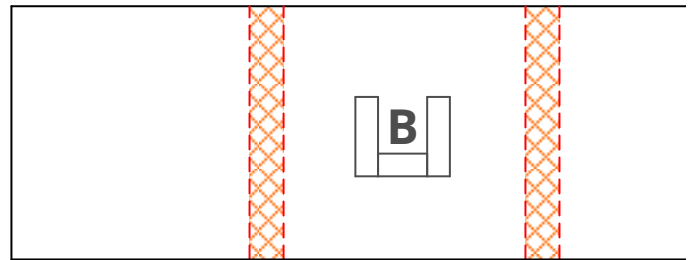
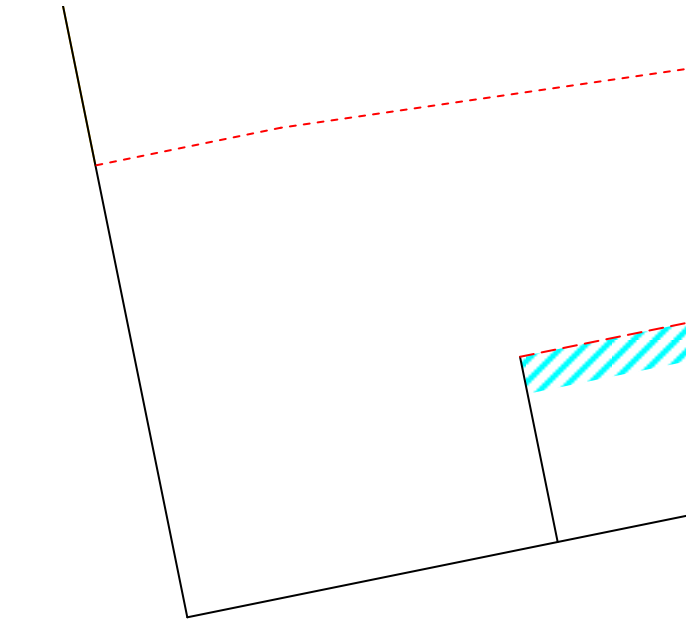

3
1 **POWER POD SUPPORT**
FOAM BOARD
AP SPERBER MSG - VERSION 2.1

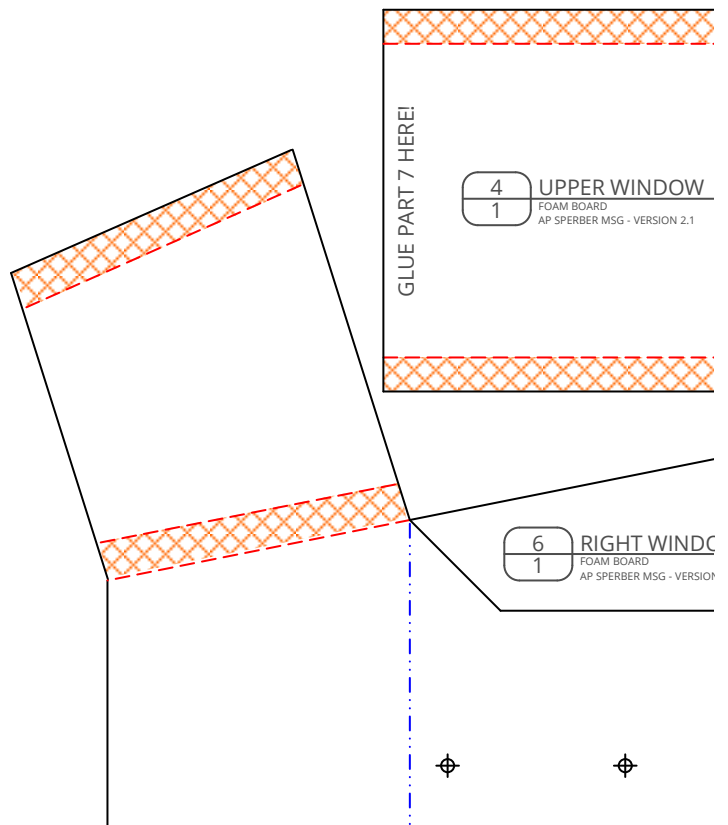

4
1 **UPPER WINDOW**
FOAM BOARD
AP SPERBER MSG - VERSION 2.1

6
1 **RIGHT WINDOW**
FOAM BOARD
AP SPERBER MSG - VERSION 2.1

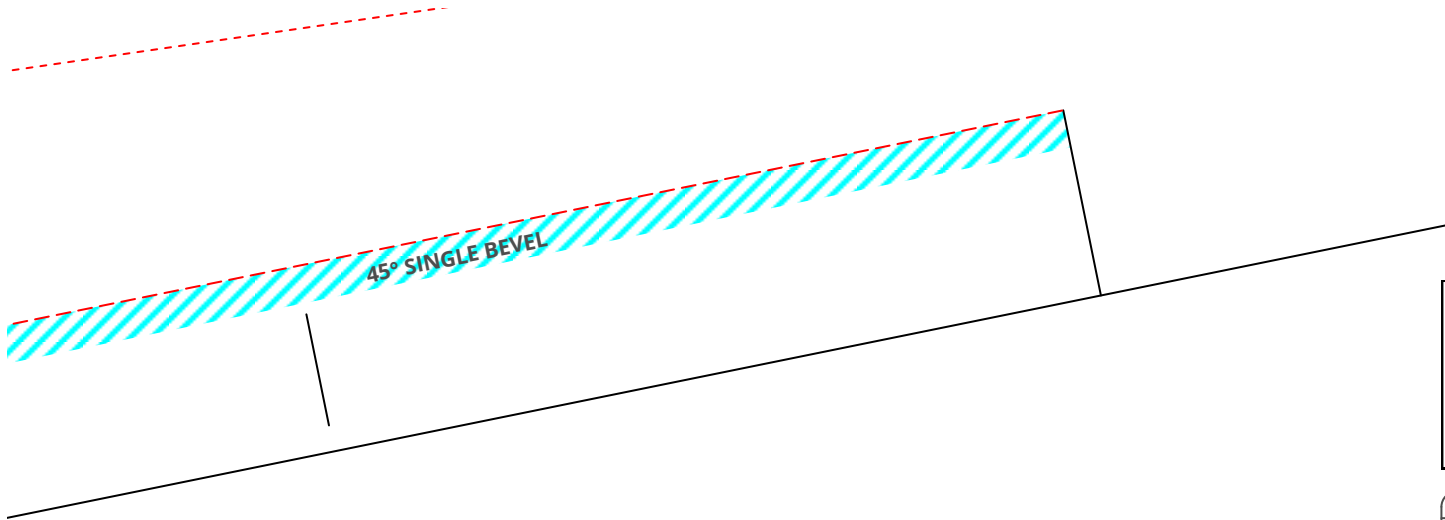

7
1 CANOPY FRONT MOUNT
FOAM BOARD
AP SPERBER MSG - VERSION 2.1

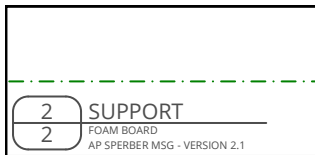

2 SUPPORT
FOAM BOARD
AP SPERBER MSG - VERSION 2.1

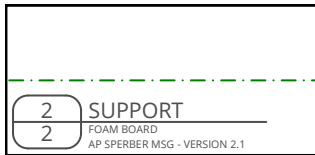

2 SUPPORT
FOAM BOARD
AP SPERBER MSG - VERSION 2.1



FT1 FT MINI POWER POD
FOAM BOARD
AP SPERBER MSG - VERSION 2.1

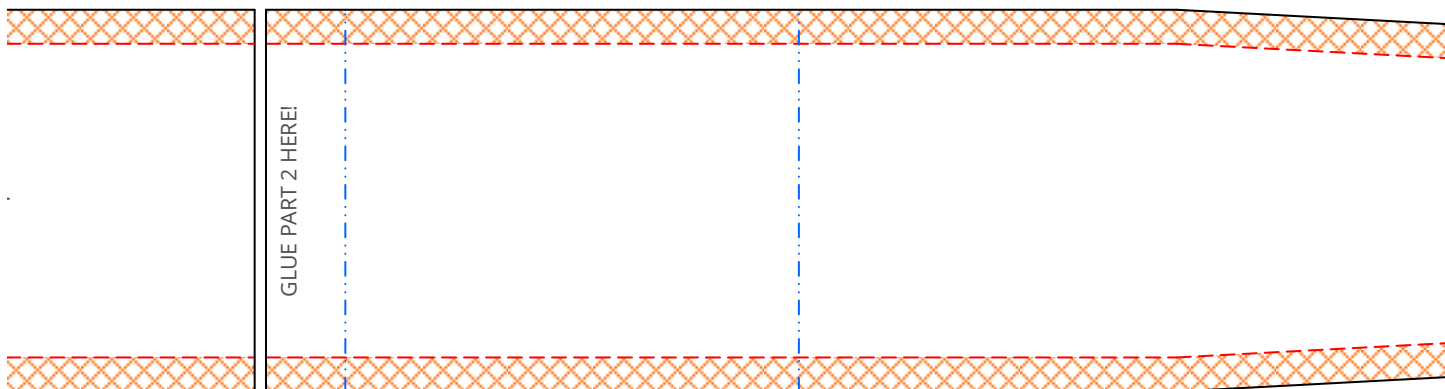

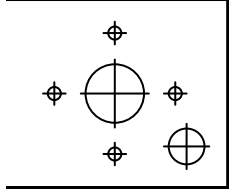
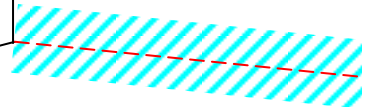

FT2 FT MINI FIREWALL
PLYWOOD
1 AP SPERBER MSG - VERSION 2.1

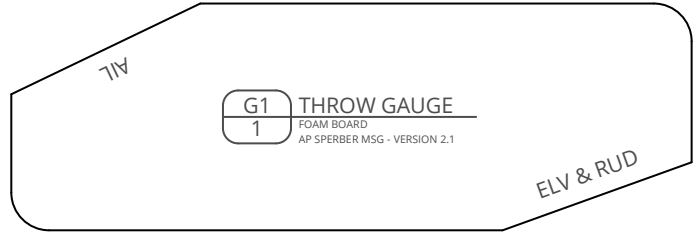
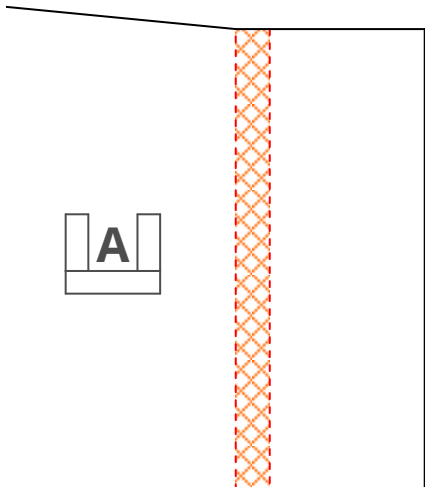
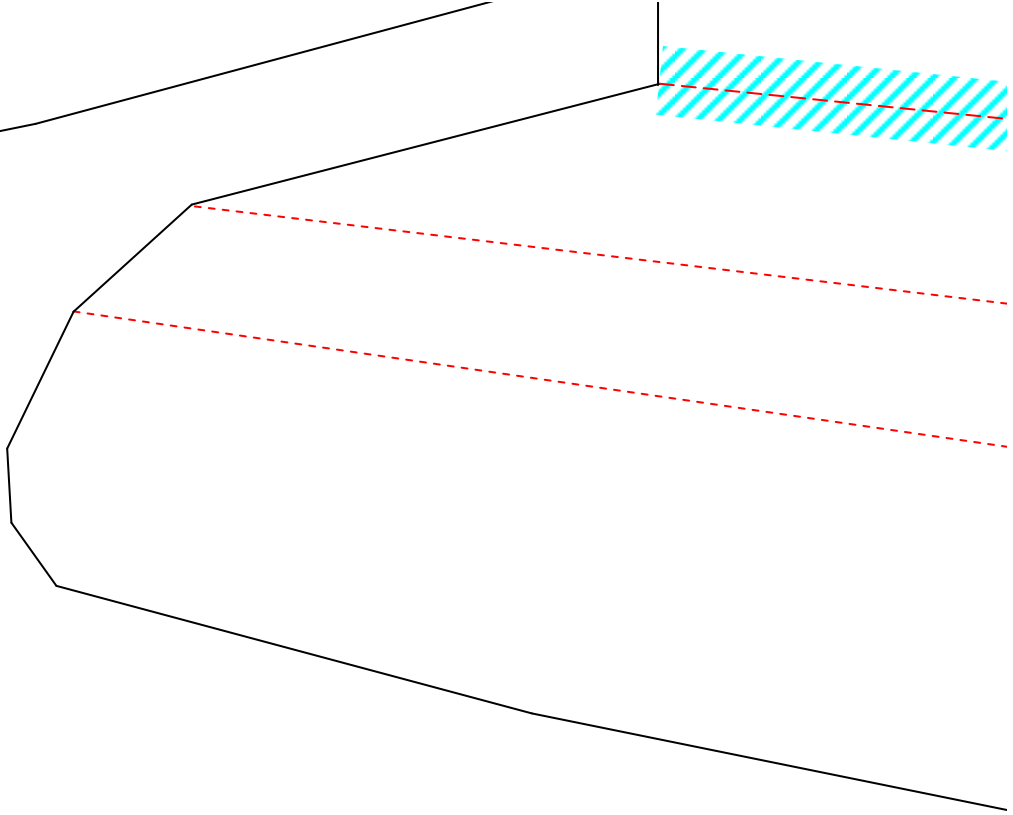

G1 THROW GAUGE
FOAM BOARD
1 AP SPERBER MSG - VERSION 2.1

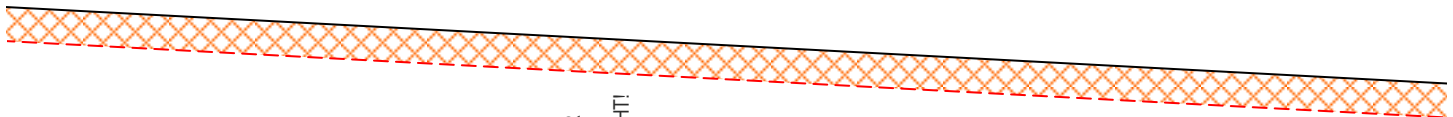

OPTIONAL:
REMOVE PAPER
IN THIS AREA
TO REDUCE WEIGHT!

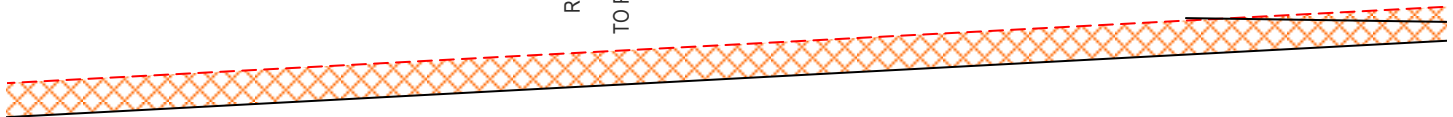

OPTIONAL:
REMOVE PAPER
IN THIS AREA
TO REDUCE WEIGHT!



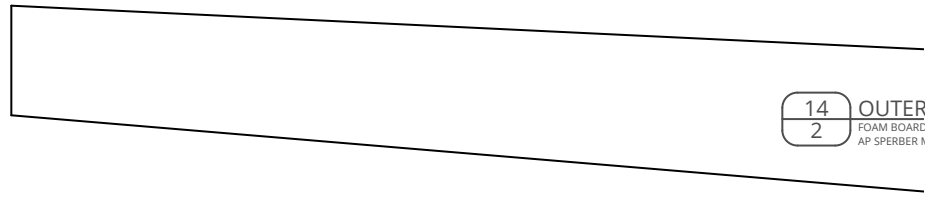
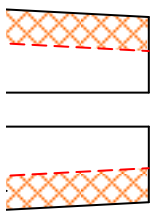
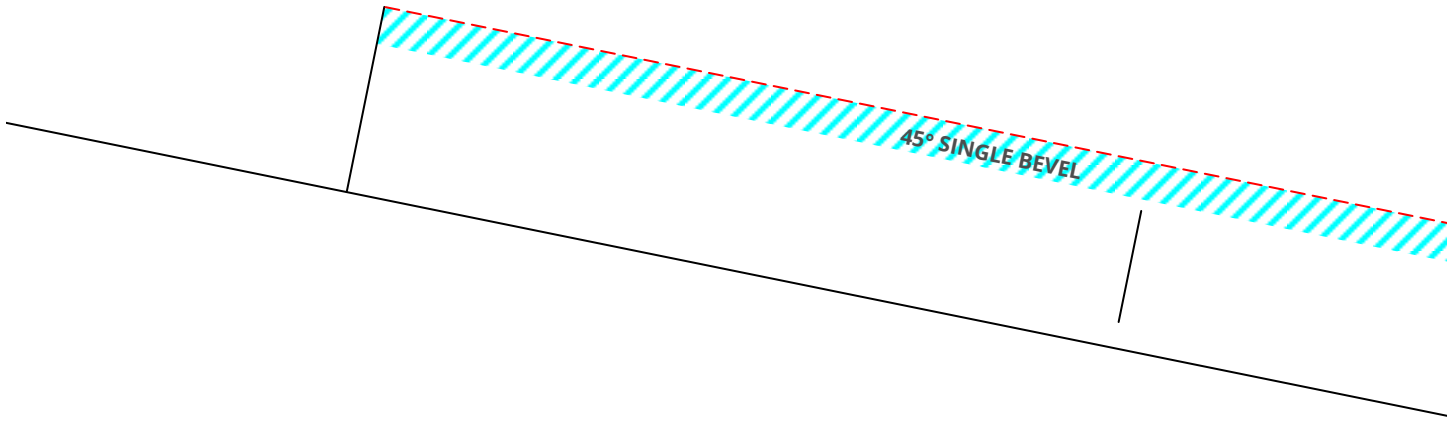
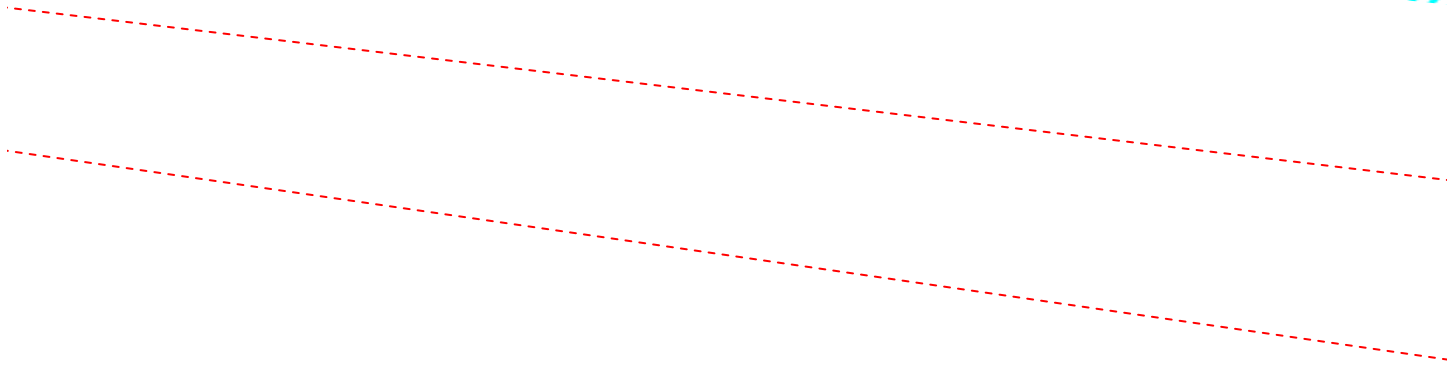
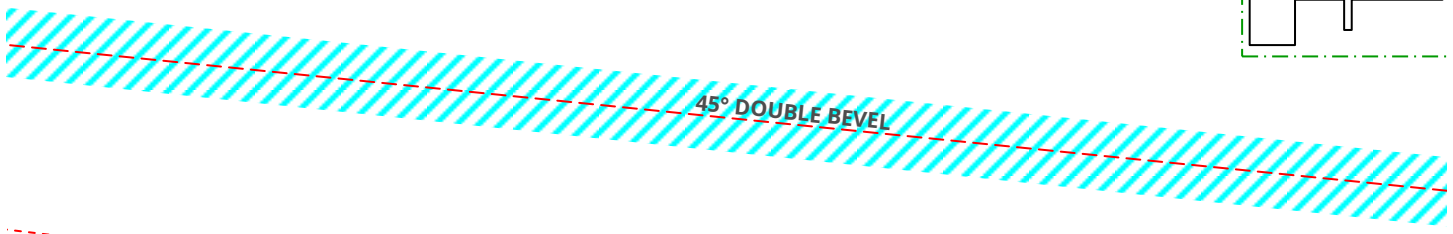
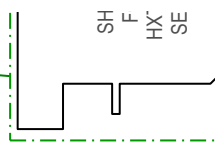

14 OUTER
FOAM BOARD
AP SPERBER M

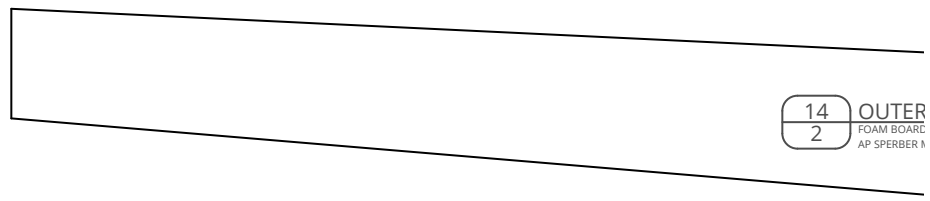

14 OUTER
FOAM BOARD
AP SPERBER M

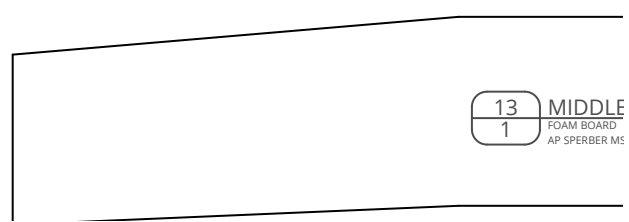
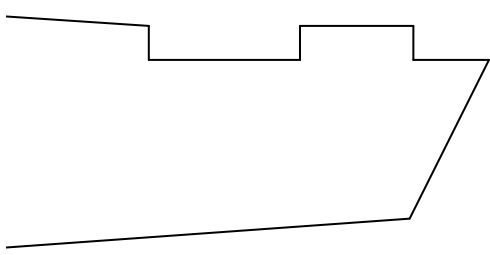

13 MIDDLE
FOAM BOARD
AP SPERBER MS

GLUE PART 13 HERE!

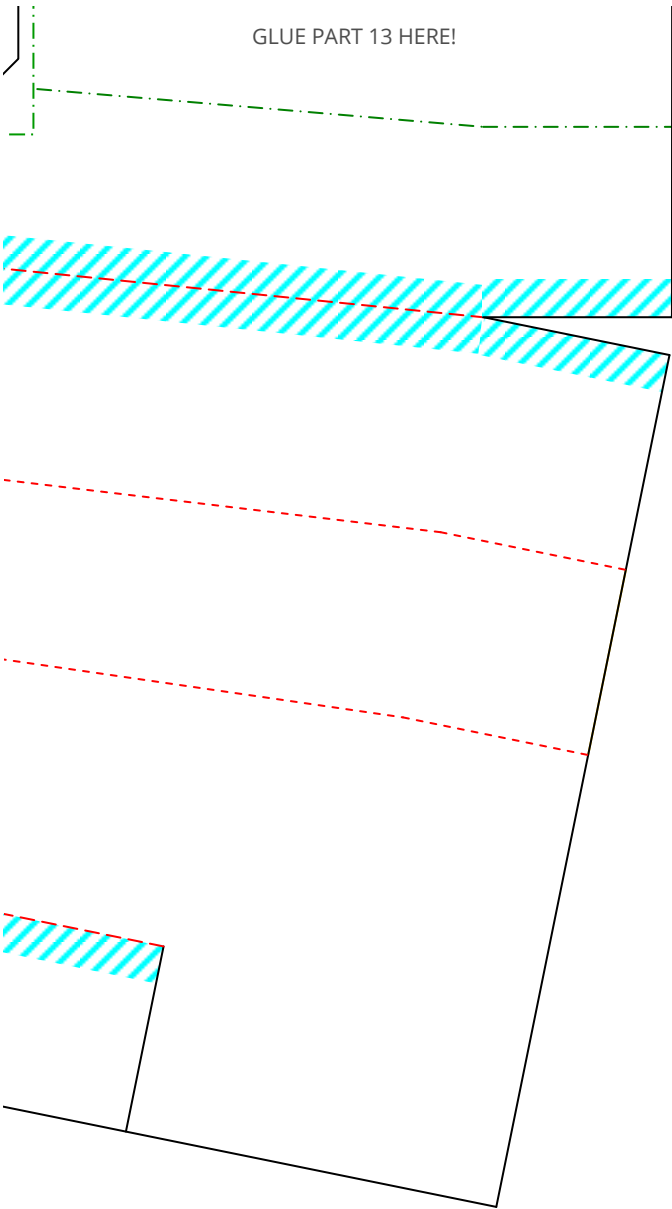

! SPAR
}
#SG - VERSION 2.1

! SPAR
}
#SG - VERSION 2.1

! SPAR
}
#G - VERSION 2.1

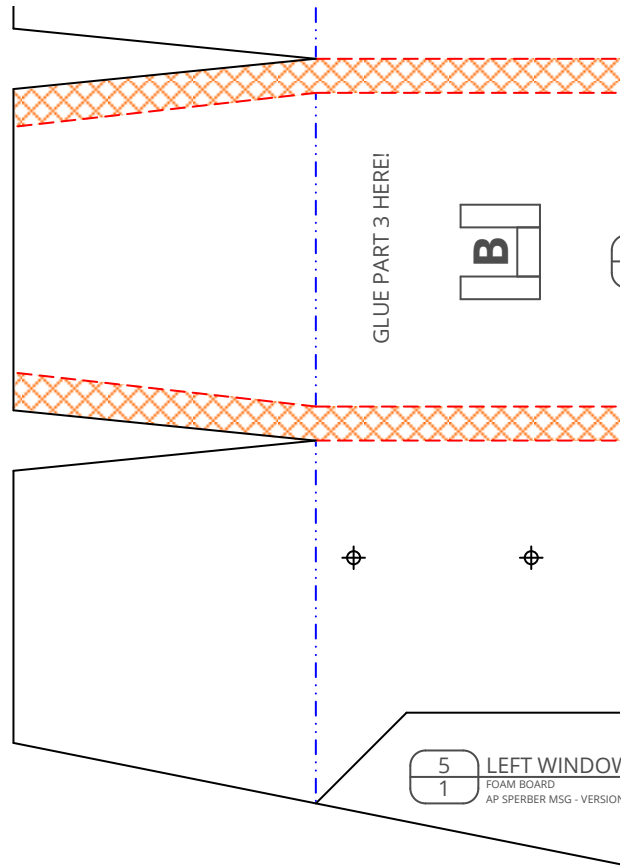

1 FUSELAGE
1 FOAM BOARD
AP SPERBER MSG - VERSION 2.1

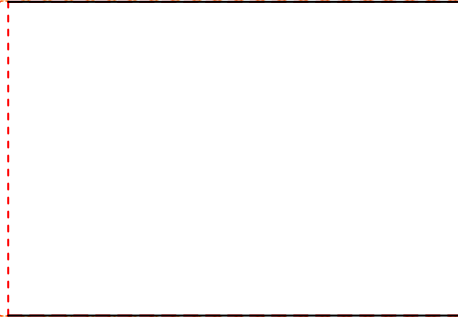

GLUE PART 2 HERE!

MOUNT
5g SERVO
HERE!

V
V.2.1

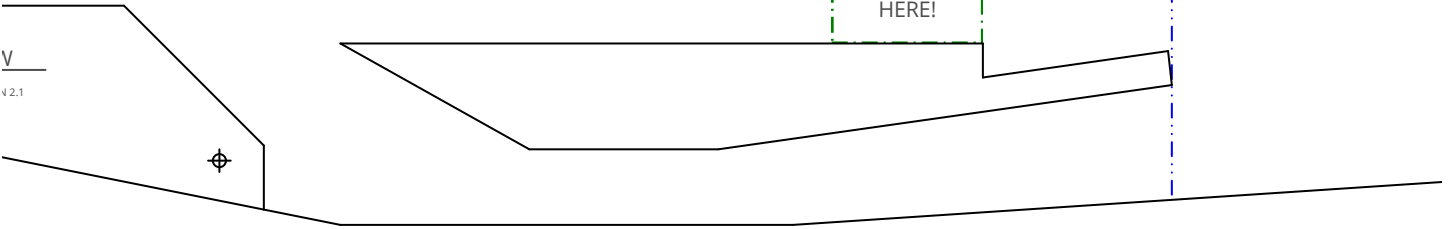

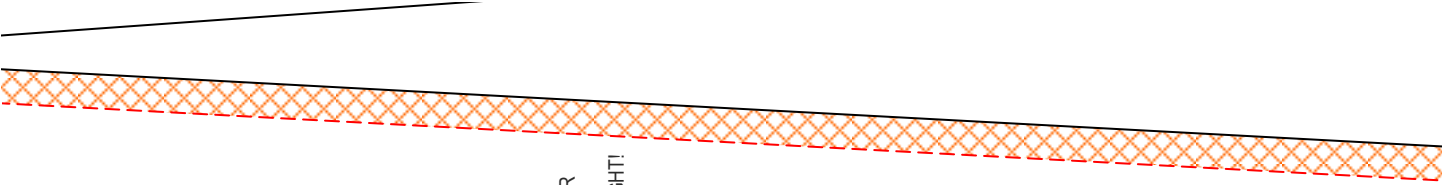

OPTIONAL:
REMOVE PAPER
IN THIS AREA
TO REDUCE WEIGHT!

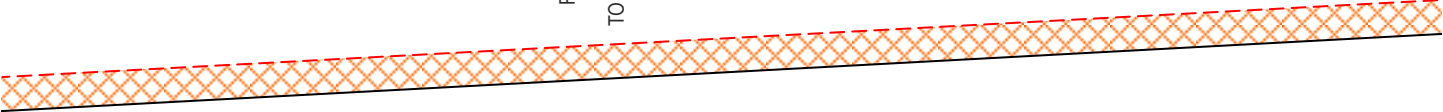

OPTIONAL:
REMOVE PAPER
IN THIS AREA
TO REDUCE WEIGHT!



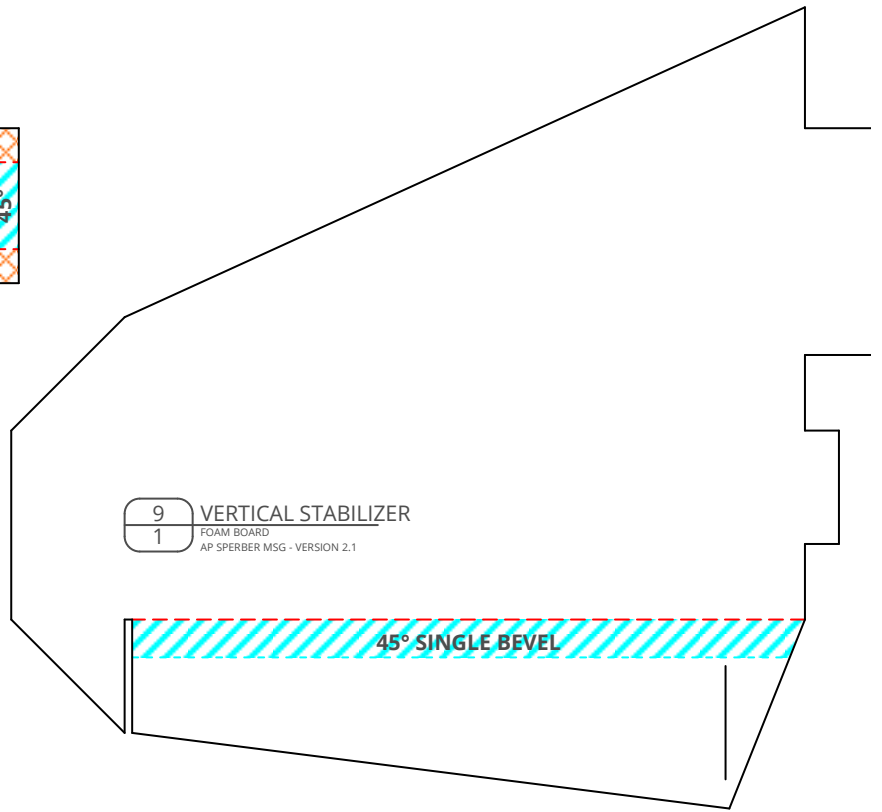
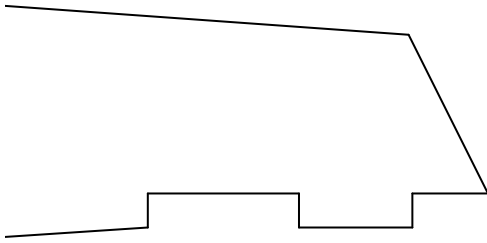
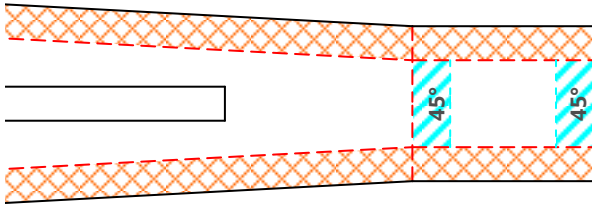

GLUE PART 10 HERE!



16 CANOPY MOUNT PIN
BBQ-SKEWER
1 AP SPERBER MSG - VERSION 2.1



15 POWER POD PIN
BBQ-SKEWER
2 AP SPERBER MSG - VERSION 2.1



10 SKID
BBQ-SKEWER
1 AP SPERBER MSG - VERSION 2.1

free of charge. Copies allowed for personal use only. Not for commercial use.